

Model : 218725-1-WH
218725-8-WH

Codes/Standards Applicable

Specified model meets or exceeds the following:

- All product dimensions are nominal.
- ASME A112.19.2
- IAPMO/cUPC®
- CSA B45
- CMR 248

Available Colors:

WHITE WH

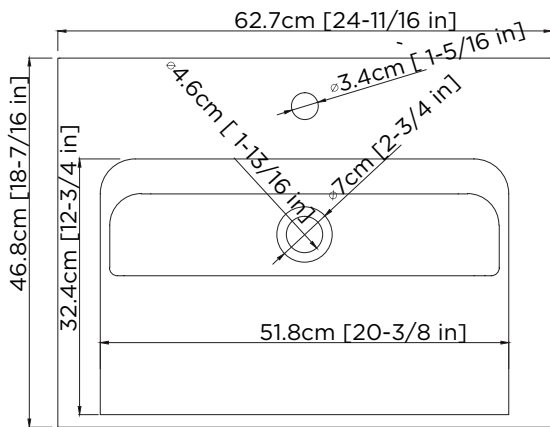

TOP

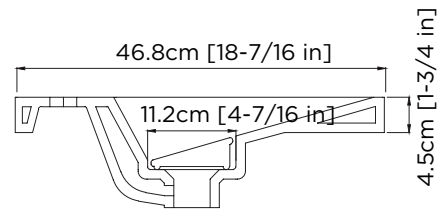

SIDE

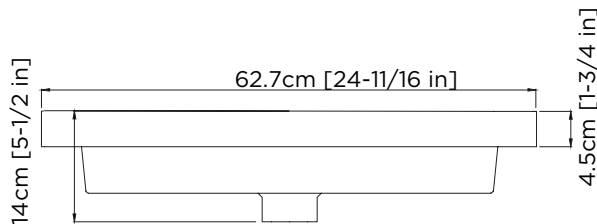

BACK

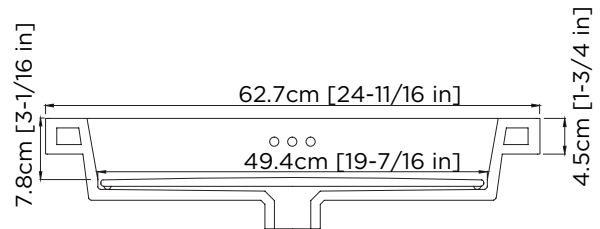

FRONT

By IAPMO, ceramic lavatory warpage is defective only if warpage of flat slab out of horizontal plane exceeds 6.3 mm/m (0.25 in/ft) on all sizes OR warpage on back of lavatories that are attached to the wall exceeds 3 mm (0.13 in).