

48"

Item Number:

527-V48-BW
527-V48-SL

JAMES MARTIN

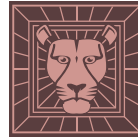

VANITIES™

Palisades 48" Single Vanity

Diagrams with Dimensions
page 01 of 03

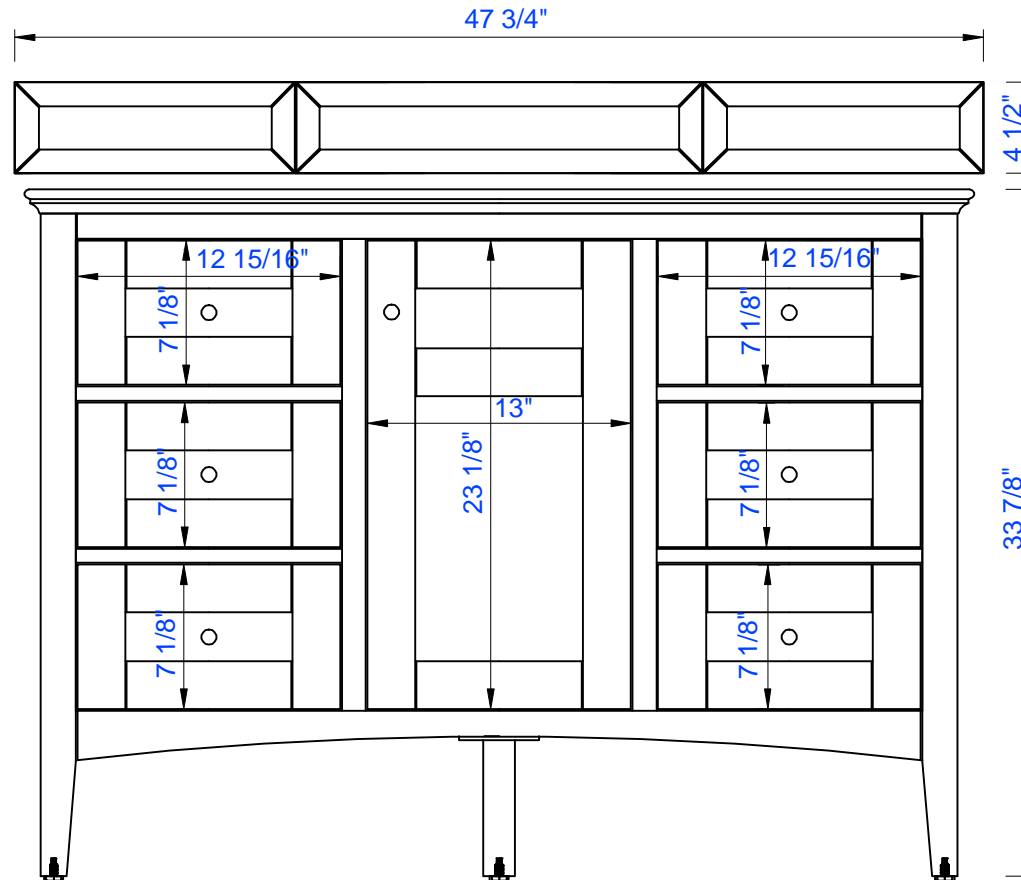

NOTE ONE: Countertops are not shown in these diagrams. (Cabinet Only)

NOTE TWO: Wood Backsplash (Shown) is designed for the molding detail to align with sinks in James Martin's Optional Countertops.

Customer's own countertops and sinks may align differently, and modification may be required.

Please consult our website for Countertop Diagrams: www.jamesmartinvanities.com

Version: 201906

48"

Item Number:

527-V48-BW
527-V48-SL

JAMES MARTIN

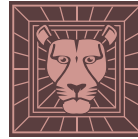

VANITIES™

Palisades 48" Single Vanity

Diagrams with Dimensions
page 02 of 03

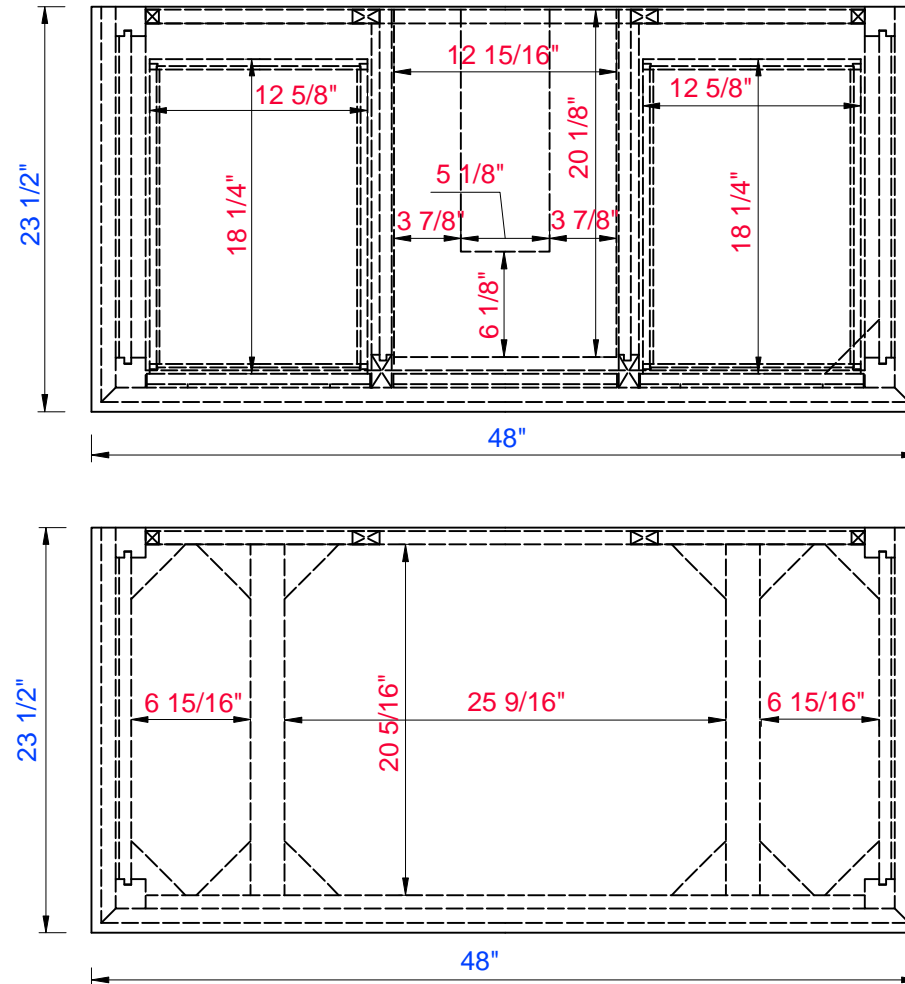

NOTE ONE: Countertops are not shown in these diagrams. (Cabinet Only)

NOTE TWO: Internal Shelves(Shown) are designed to align with sinks in James Martin's Optional Countertops. Customer's own countertops and sink may align differently, and modification may be required. Please consult our website for Countertop Diagrams: www.jamesmartinvanities.com

48"

Item Number:

527-V48-BW
527-V48-SL

JAMES MARTIN

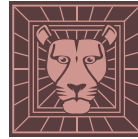

VANITIES™

Palisades 48" Single Vanity

Diagrams with Dimensions
page 03 of 03

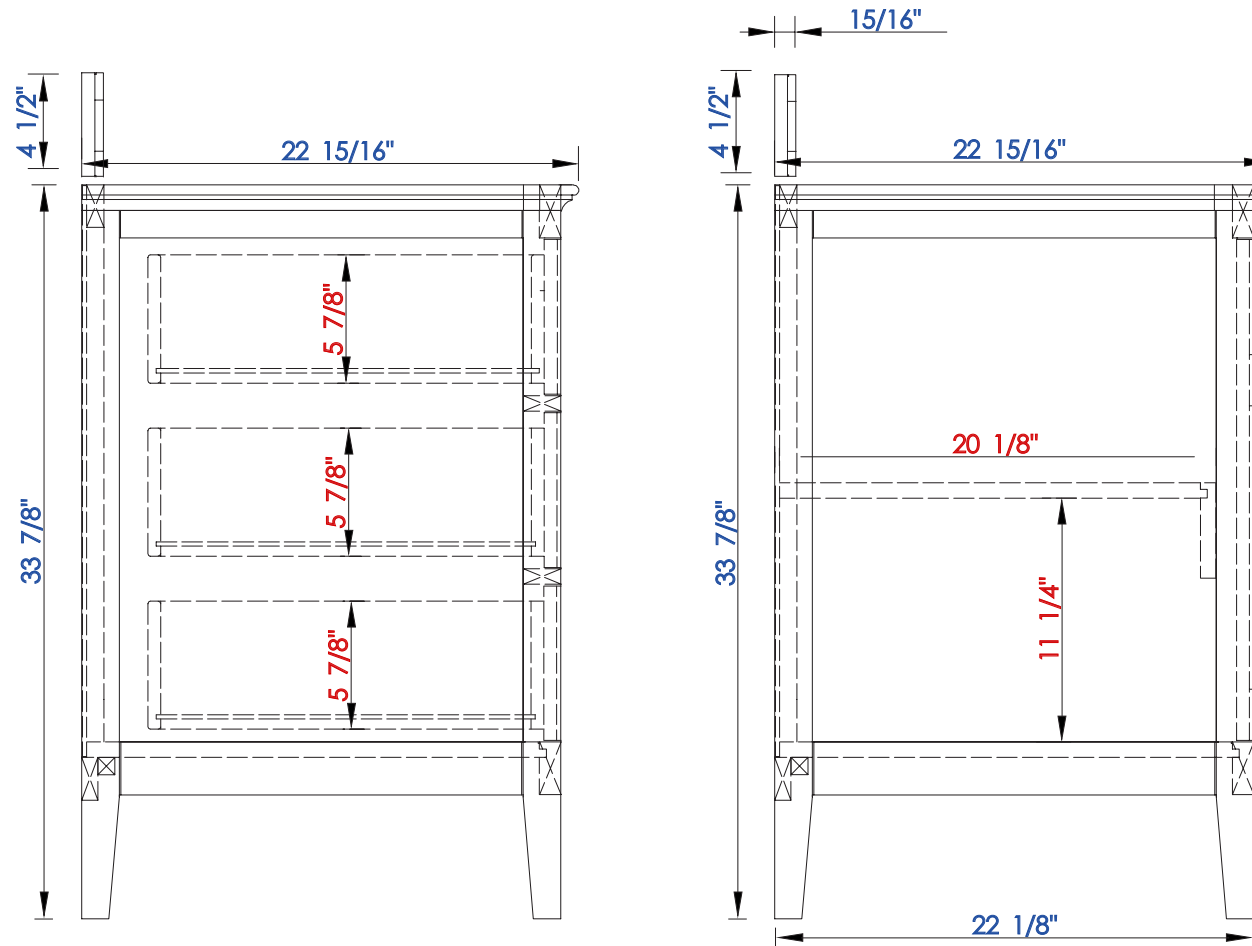

NOTE ONE: Countertops are not shown in these diagrams. (Cabinet Only)

NOTE TWO: Wood Backsplash (Shown) is designed for the molding detail to align with sinks in James Martin's Optional Countertops. Customer's own countertops and sinks may align differently, and modification may be required.

Please consult our website for Countertop Diagrams: www.jamesmartinvanities.com

1219 mm

Item Number:
527-V48-BW
527-V48-SL

JAMES MARTIN



VANITIES™

Palisades 1219mm Double Vanity

Diagrams with Dimensions
page 01 of 03

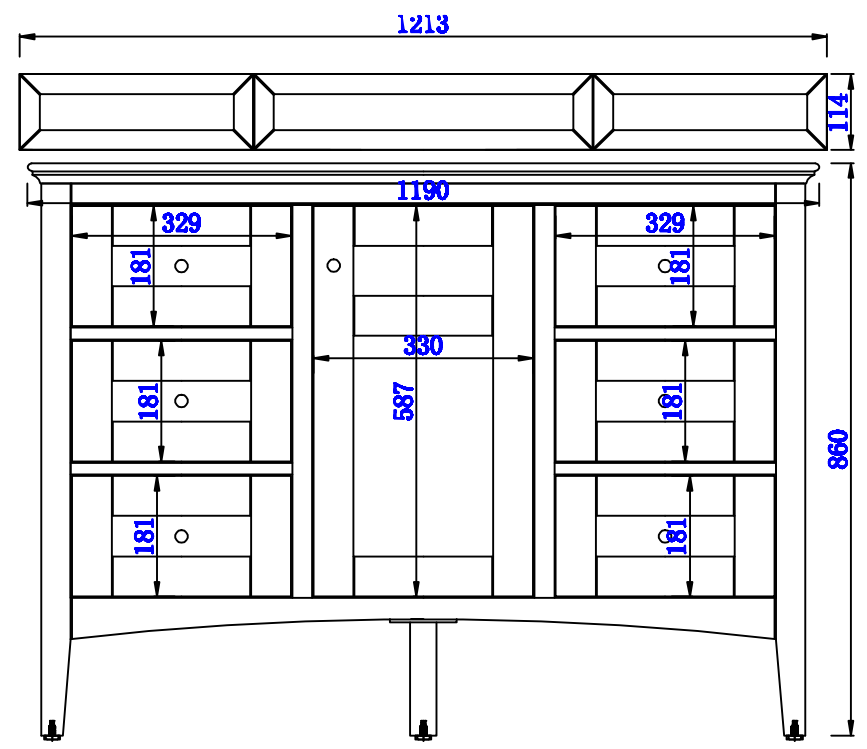

NOTE ONE: Countertops are not shown in these diagrams. (Cabinet Only)

NOTE TWO: Wood Backsplash (Shown) is designed for the molding detail to align with sinks in James Martin's Optional Countertops.

Customer's own countertops and sinks may align differently, and modification may be required.

Please consult our website for Countertop Diagrams: www.jamesmartinvanities.com

1219 mm

Item Number:
527-V48-BW
527-V48-SL

JAMES MARTIN



VANITIES™

Palisades 1219mm Single Vanity

Diagrams with Dimensions
page 02 of 03

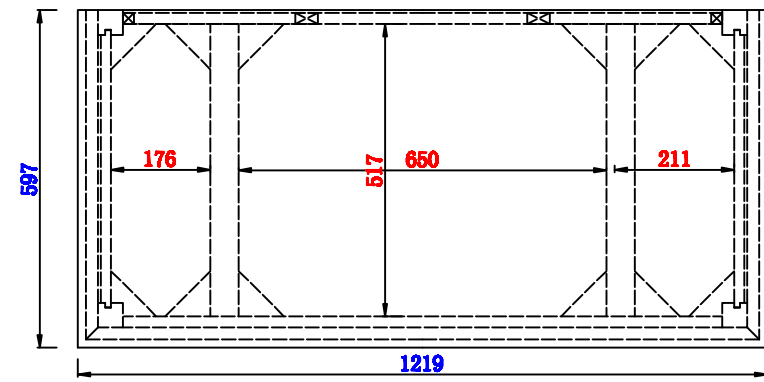
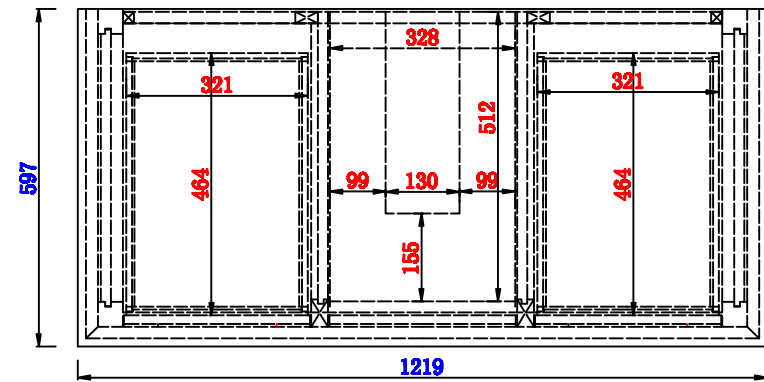

NOTE ONE: Countertops are not shown in these diagrams. (Cabinet Only)
NOTE TWO: Internal Shelves(Shown) are designed to align with sinks in James Martin's Optional Countertops.
Customer's own countertops and sink may align differently, and modification may be required.
Please consult our website for Countertop Diagrams: www.jamesmartinvanities.com

1219 mm

Item Number:

JAMES MARTIN

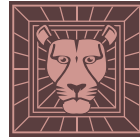

VANITIES™

Palisades 1219mm Single Vanity

Diagrams with Dimensions
page 03 of 03

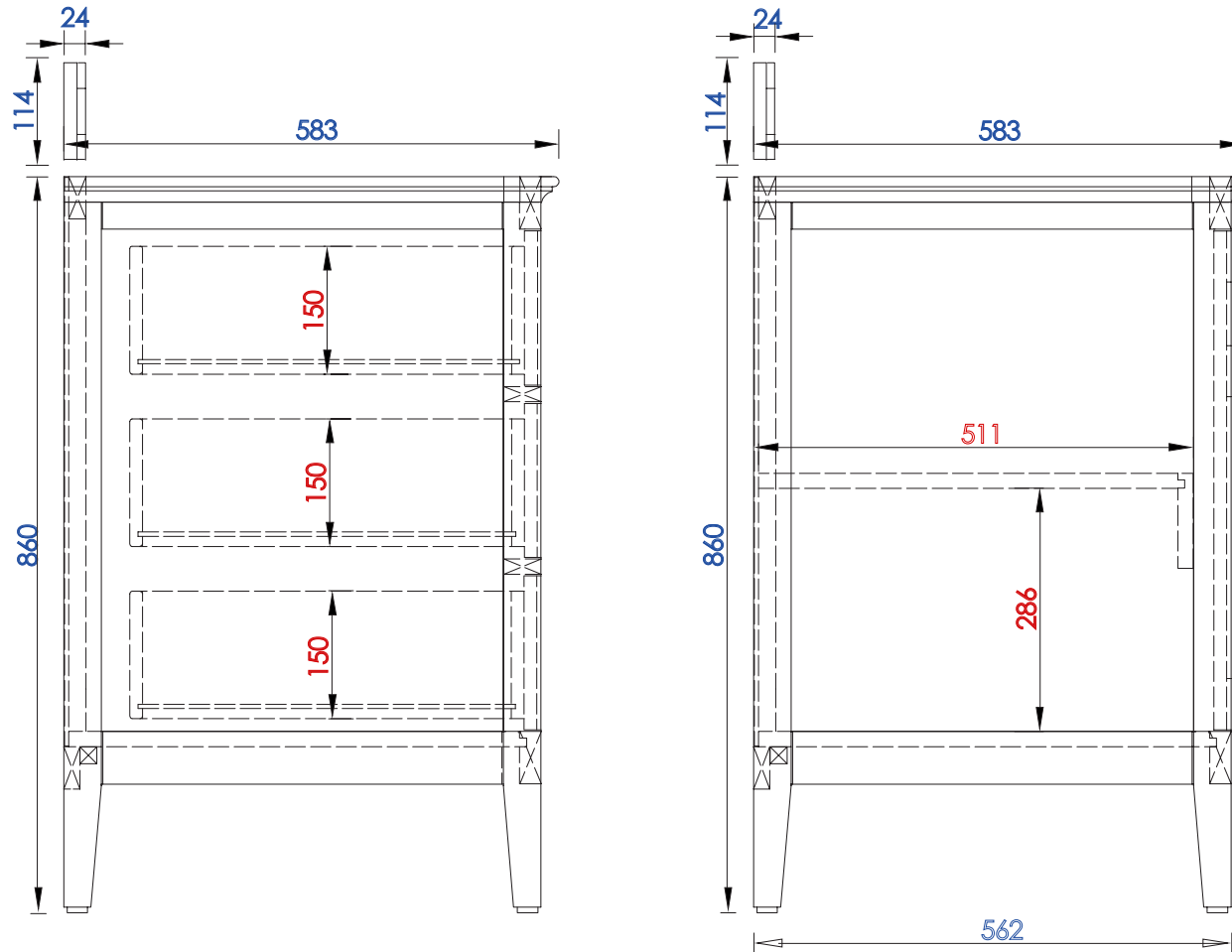

NOTE ONE: Countertops are not shown in these diagrams. (Cabinet Only)

NOTE TWO: Wood Backsplash (Shown) is designed for the molding detail to align with sinks in James Martin's Optional Countertops. Customer's own countertops and sinks may align differently, and modification may be required.

Please consult our website for Countertop Diagrams: www.jamesmartinvanities.com



48" Vanity Top Spec Sheet

James Martin Vanities Company always recommends you consult and/or hire a professional contractor when installing your vanity cabinet and top.

3cm/1.18"
Countertop

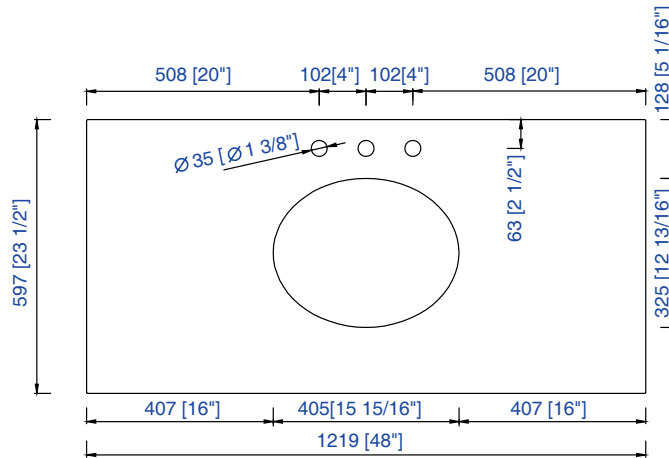

James Martin - Natural Stone Countertop Measurement Specification

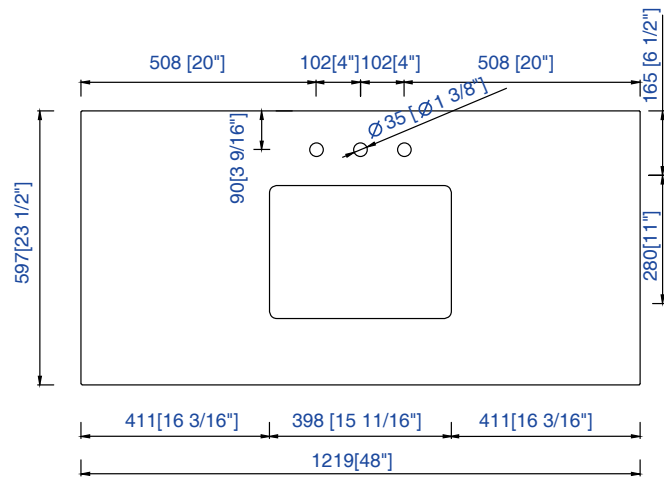

James Martin - Natural Stone & Solid Surface Countertop Measurement Specification

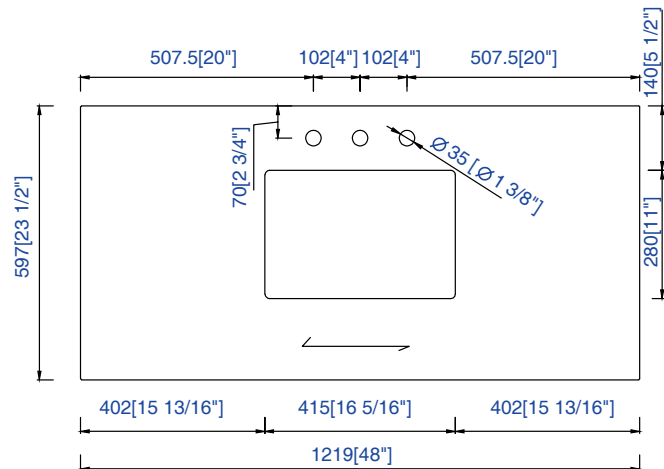

James Martin - Quartz Countertop Measurement Specification