

30"

Item Number:

301-V30-BNM
301-V30-SL

JAMES MARTIN



VANITIES

Copper Cove Encore 30" Single Vanity

Diagrams with Dimensions
page 01 of 03

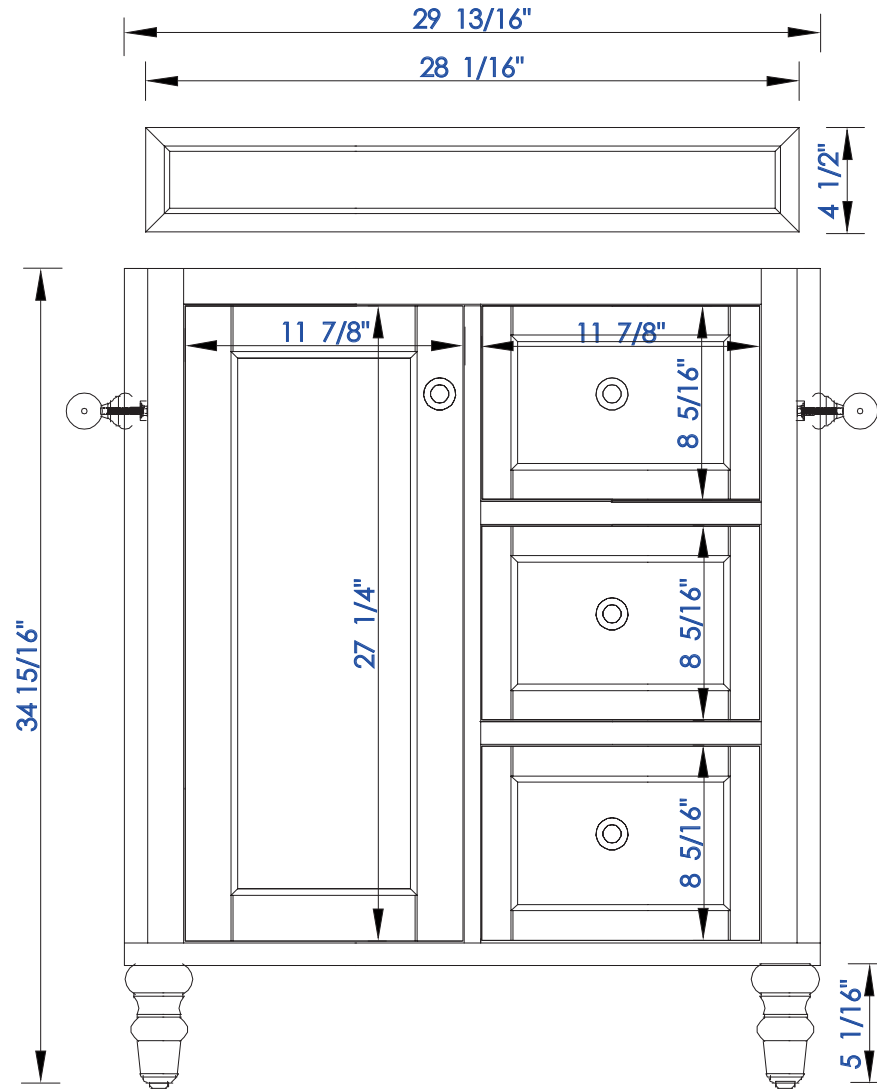

NOTE ONE: Countertops are not shown in these diagrams. (Cabinet Only)

NOTE TWO: Wood Backsplash (Shown) is designed for the molding detail to align with sinks in James Martin's Optional Countertops.

Customer's own countertops and sinks may align differently, and modification may be required.

Please consult our website for Countertop Diagrams: www.jamesmartinvanities.com

30"

Item Number:

301-V30-BMN
301-V30-SL

JAMES MARTIN



VANITIES

Copper Cove Encore 30" Single Vanity

Diagrams with Dimensions
page 02 of 03

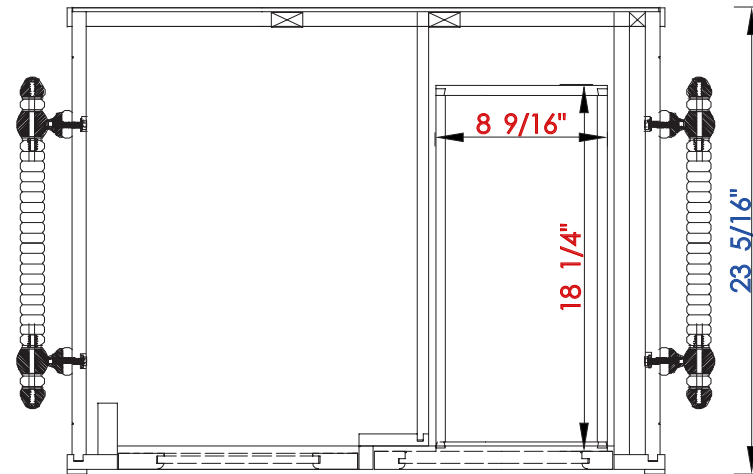
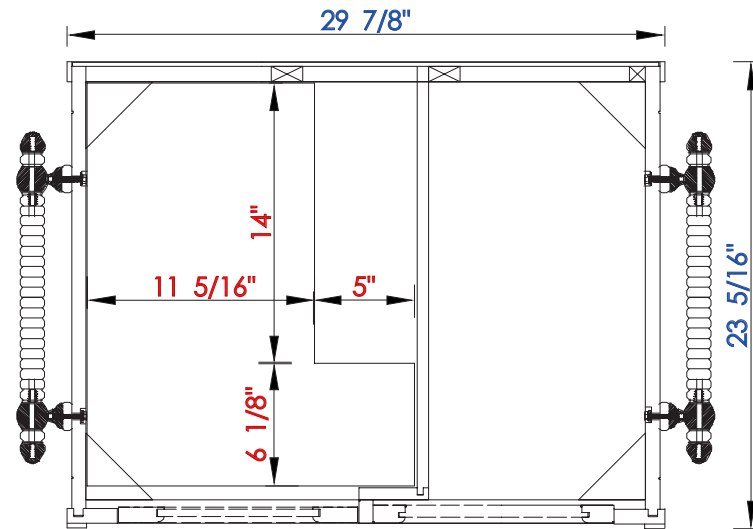

NOTE ONE: Countertops are not shown in these diagrams. (Cabinet Only)

NOTE TWO: Internal Shelves(Shown) are designed to align with sinks in James Martin's Optional Countertops.

Customer's own countertops and sink may align differently, and modification may be required.

Please consult our website for Countertop Diagrams: www.jamesmartinvanities.com

30"

Item Number:

301-V30-BMN
301-V30-SL

JAMES MARTIN



VANITIES

Copper Cove Encore 30" Single Vanity

Diagrams with Dimensions
page 03 of 03

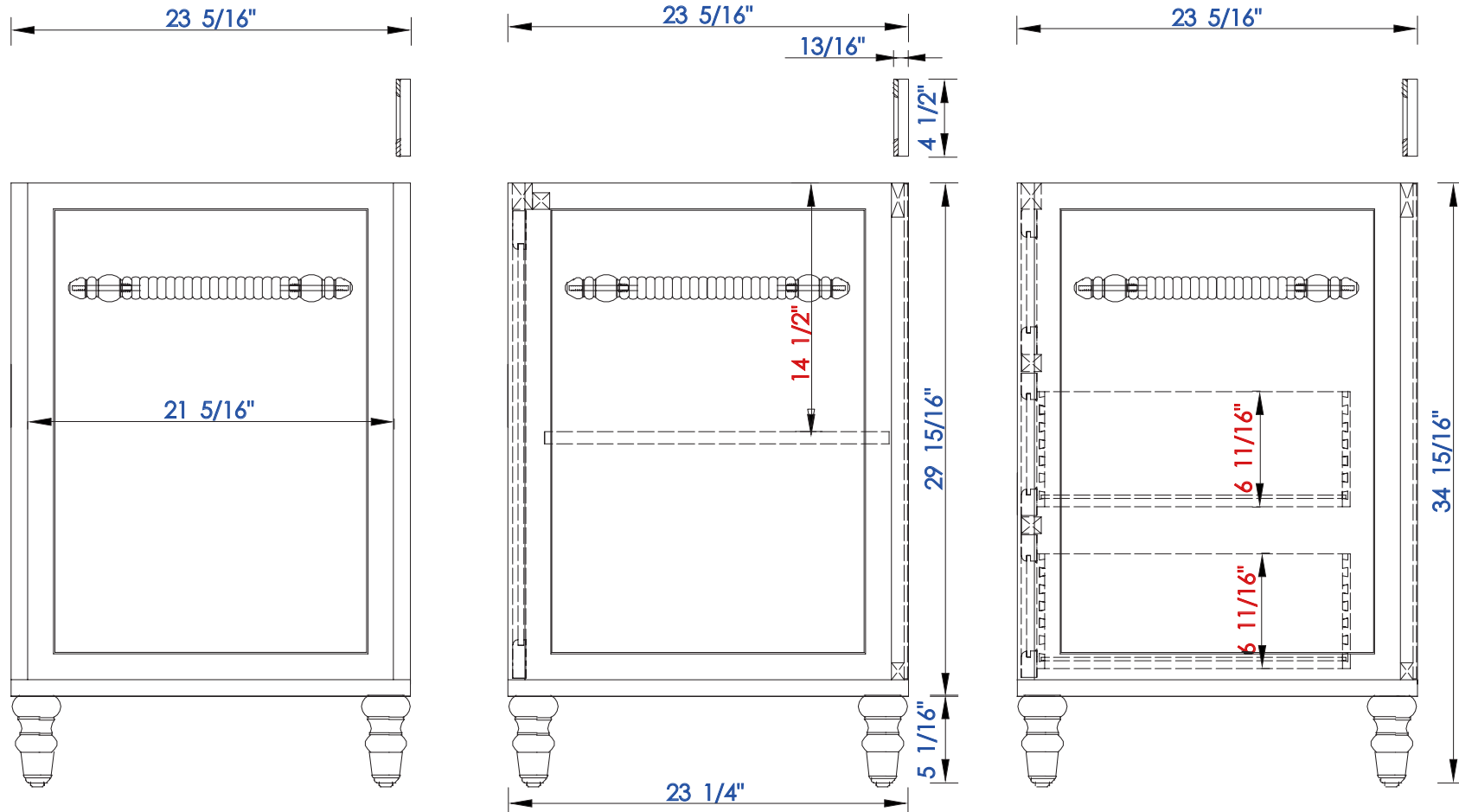

NOTE ONE: Countertops are not shown in these diagrams. (Cabinet Only)

NOTE TWO: Wood Backsplash (Shown) is designed for the molding detail to align with sinks in James Martin's Optional Countertops.

Customer's own countertops and sinks may align differently, and modification may be required.

Please consult our website for Countertop Diagrams: www.jamesmartinvanities.com

762 mm

Item Number:

301-V30-BNM
301-V30-SL

JAMES MARTIN



VANITIES

Copper Cove Encore 762mm Single Vanity

Diagrams with Dimensions
page 01 of 03

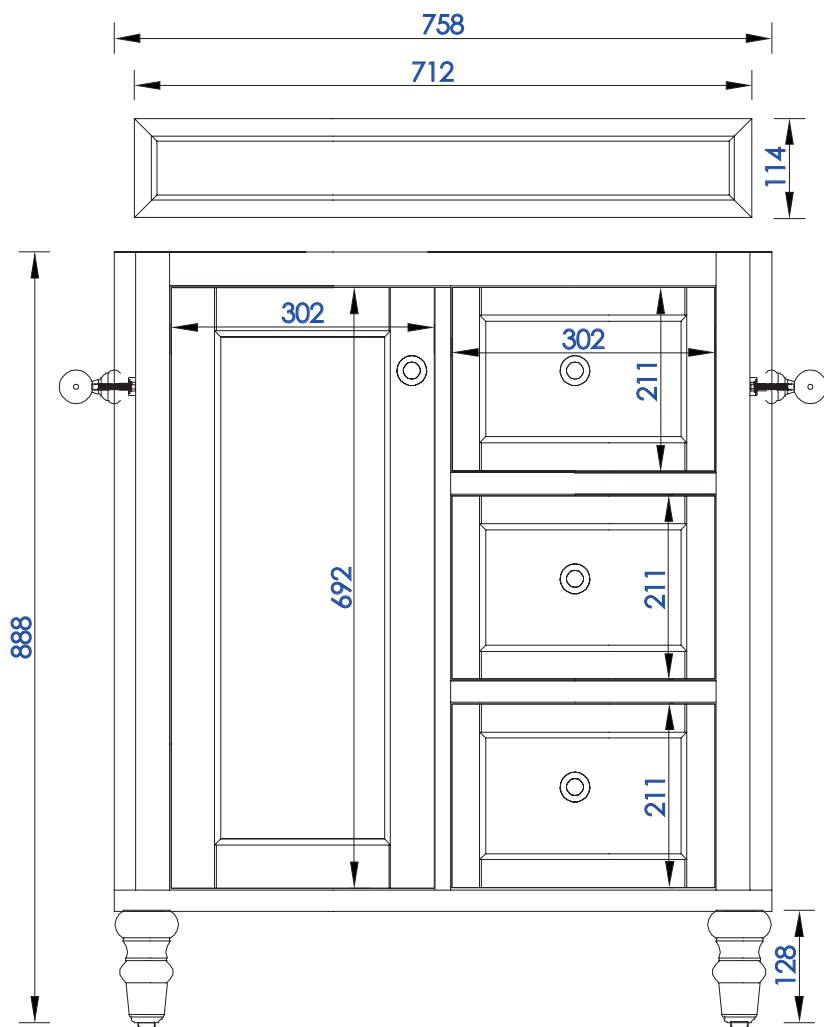

NOTE ONE: Countertops are not shown in these diagrams. (Cabinet Only)

NOTE TWO: Wood Backsplash (Shown) is designed for the molding detail to align with sinks in James Martin's Optional Countertops.

Customer's own countertops and sinks may align differently, and modification may be required.

Please consult our website for Countertop Diagrams: www.jamesmartinvanities.com

762 mm

Item Number:

301-V30-BNM
301-V30-SL

JAMES MARTIN



VANITIES

Copper Cove Encore 762mm Single Vanity

Diagrams with Dimensions
page 02 of 03

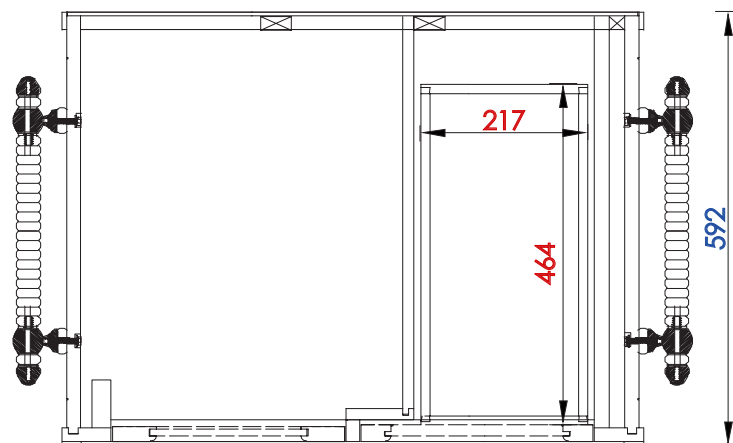
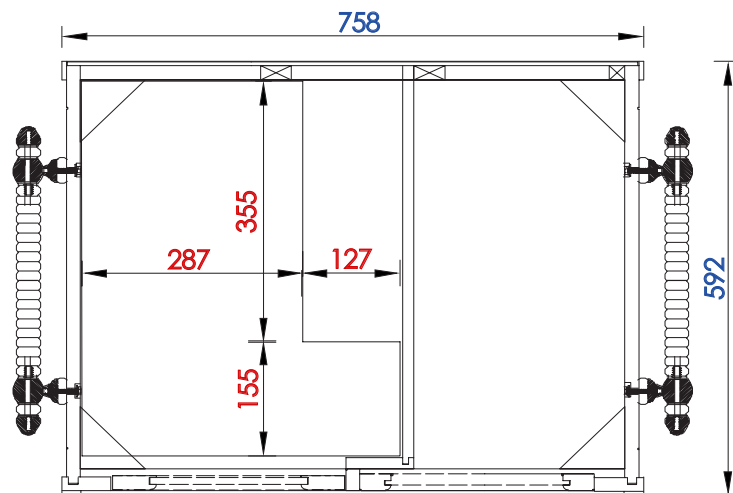

NOTE ONE: Countertops are not shown in these diagrams. (Cabinet Only)

NOTE TWO: Internal Shelves(Shown) are designed to align with sinks in James Martin's Optional Countertops.

Customer's own countertops and sink may align differently, and modification may be required.

Please consult our website for Countertop Diagrams: www.jamesmartinvanities.com

762 mm

Item Number:

301-V30-BNM
301-V30-SL

JAMES MARTIN



VANITIES

Copper Cove Encore 762mm Single Vanity

Diagrams with Dimensions
page 03 of 03

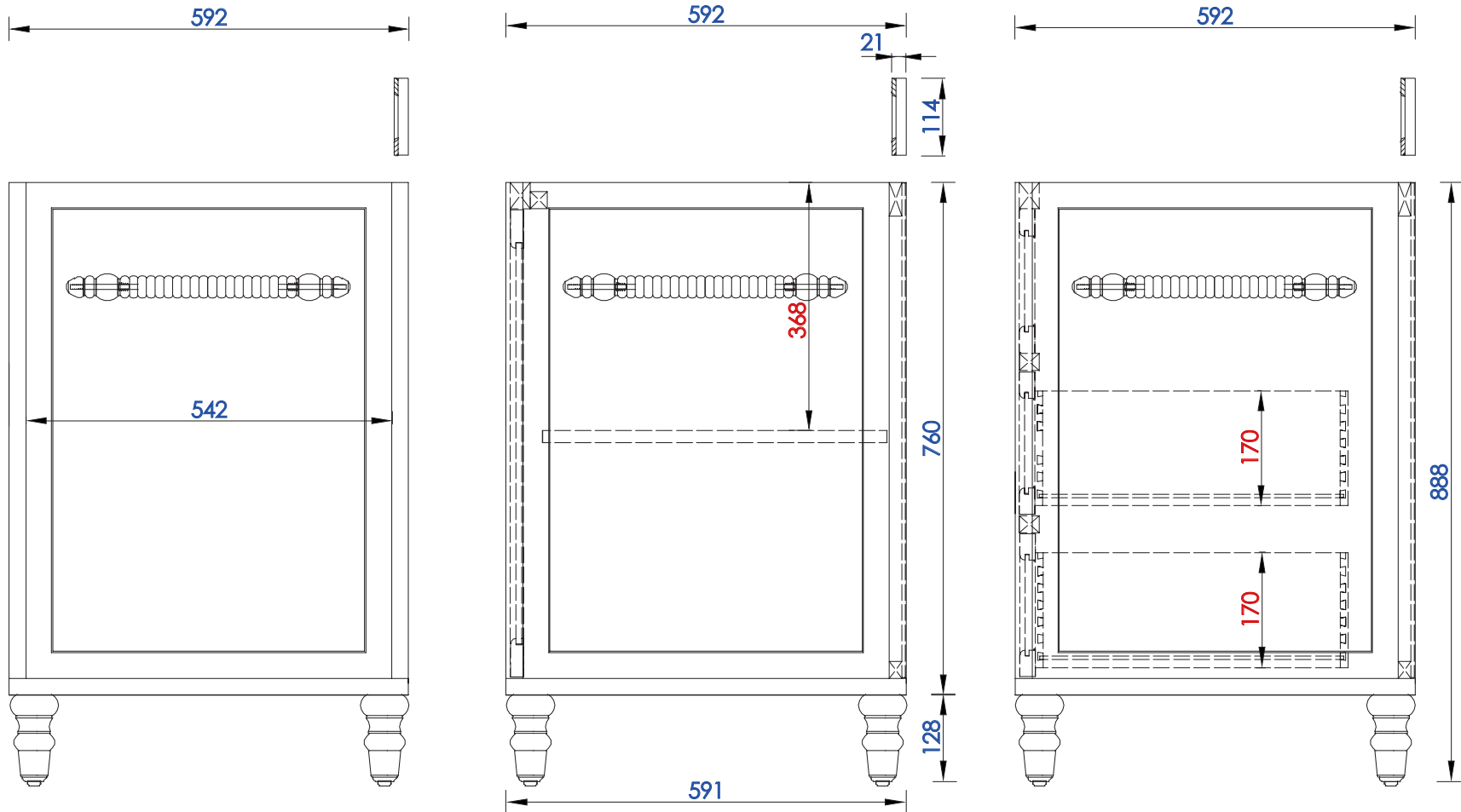

NOTE ONE: Countertops are not shown in these diagrams. (Cabinet Only)

NOTE TWO: Wood Backsplash (Shown) is designed for the molding detail to align with sinks in James Martin's Optional Countertops.

Customer's own countertops and sinks may align differently, and modification may be required.

Please consult our website for Countertop Diagrams: www.jamesmartinvanities.com