

1518-WV3618

Step 1: Detach mounting bracket from vanity

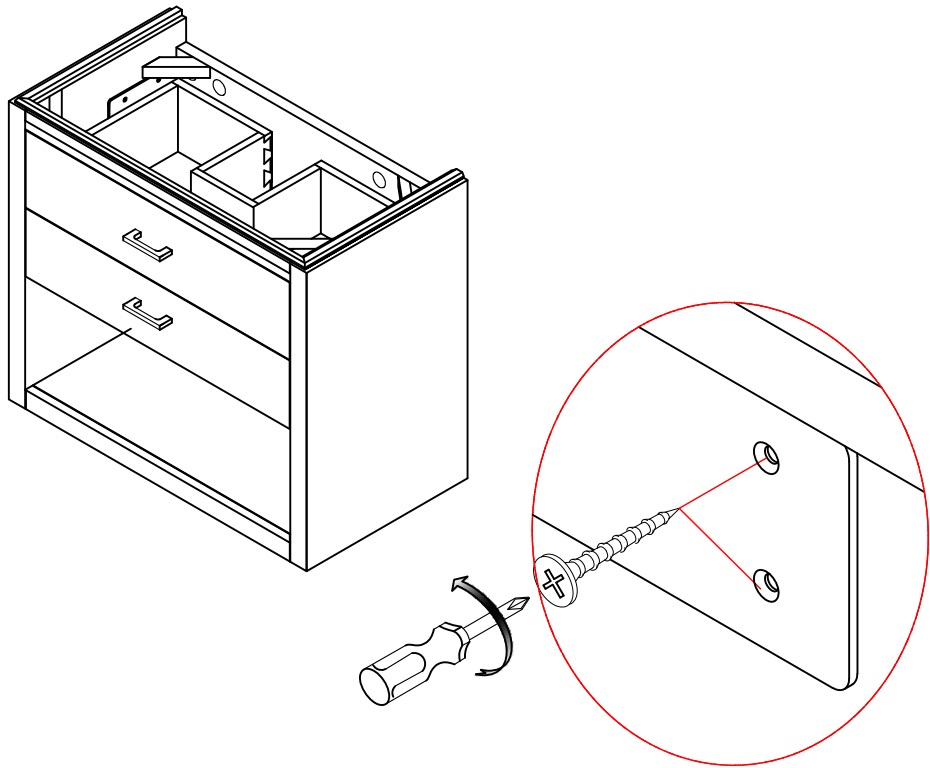

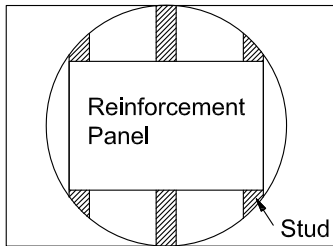





Cut opening in wall

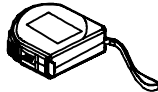

Reinforcement Panel

- * Large enough to cover 2 studs
- * Not provided by manufacturer

Parts Included				Tools And Materials			
1		50x50x50x3mm	2pcs	  	Screwdriver	Tape measure	Pencil
2		Ø8x38mm	10pcs				
3		Ø8x19mm	2pcs				
4		Ø10x28mm	10pcs				

Fairmont Designs highly recommends that you seek a professional installation specialist if you are unsure of installation. Please note: Fairmont Designs is not responsible for any installation error, damages or injuries, actual or consequential resulting from possible printing error in instruction

1518-WV3618

Step 2: Mounting bracket must be attached to reinforcement panel.

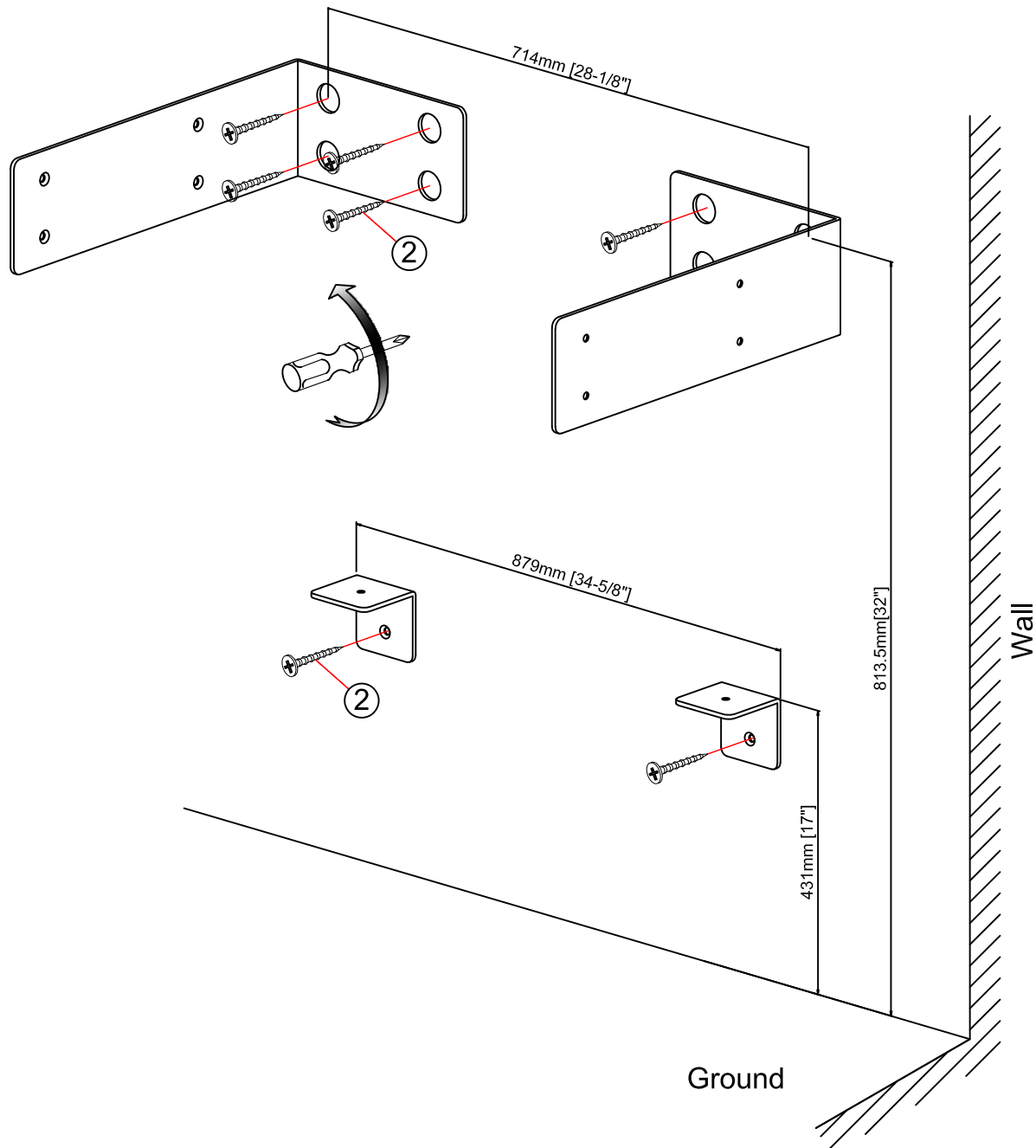

Fairmont Designs highly recommends that you seek a professional installation specialist if you are unsure of installation. Please note: Fairmont Designs is not responsible for any installation error, damages or injuries, actual or consequential resulting from possible printing error in instruction

1518-WV3618

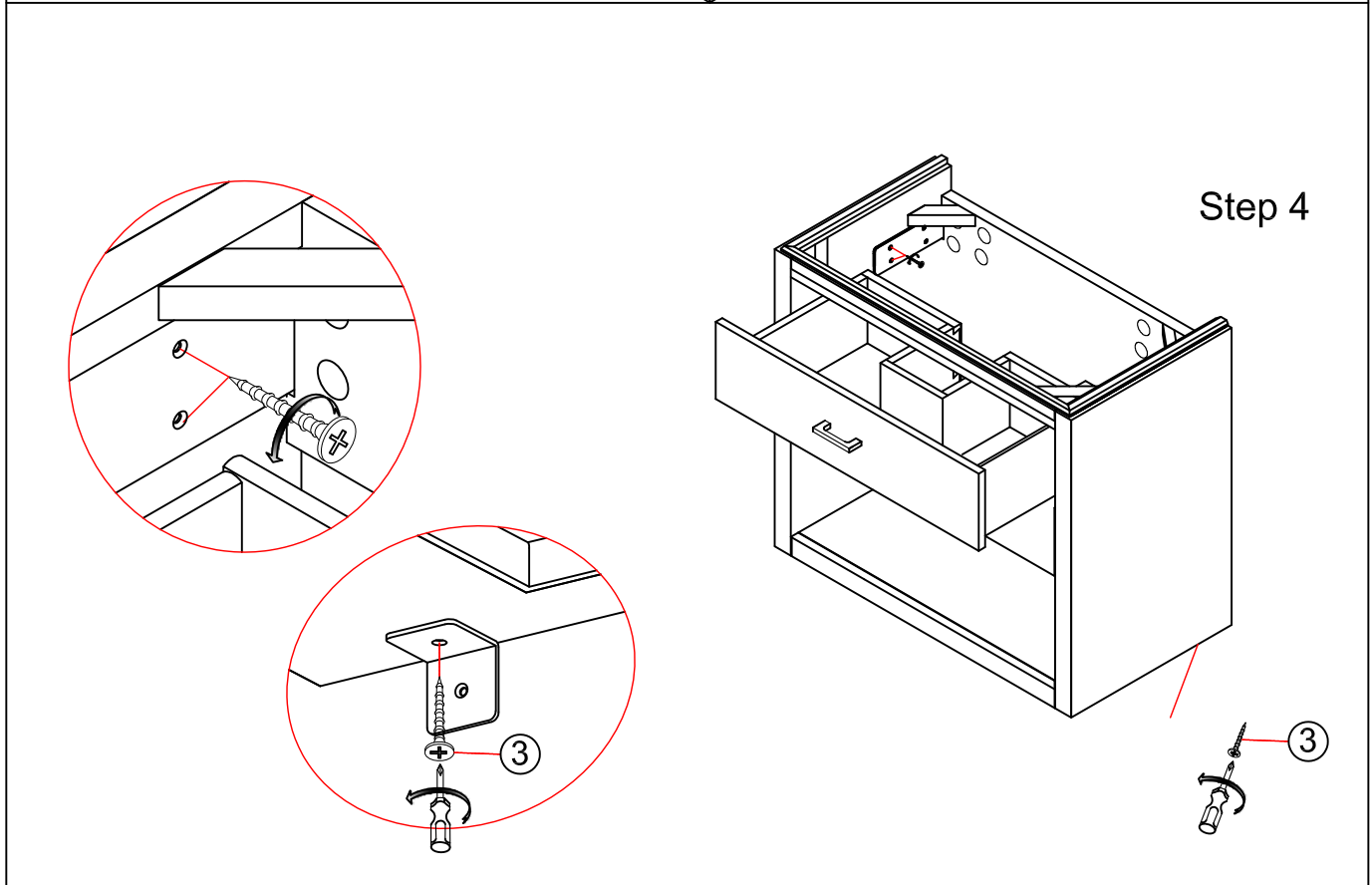
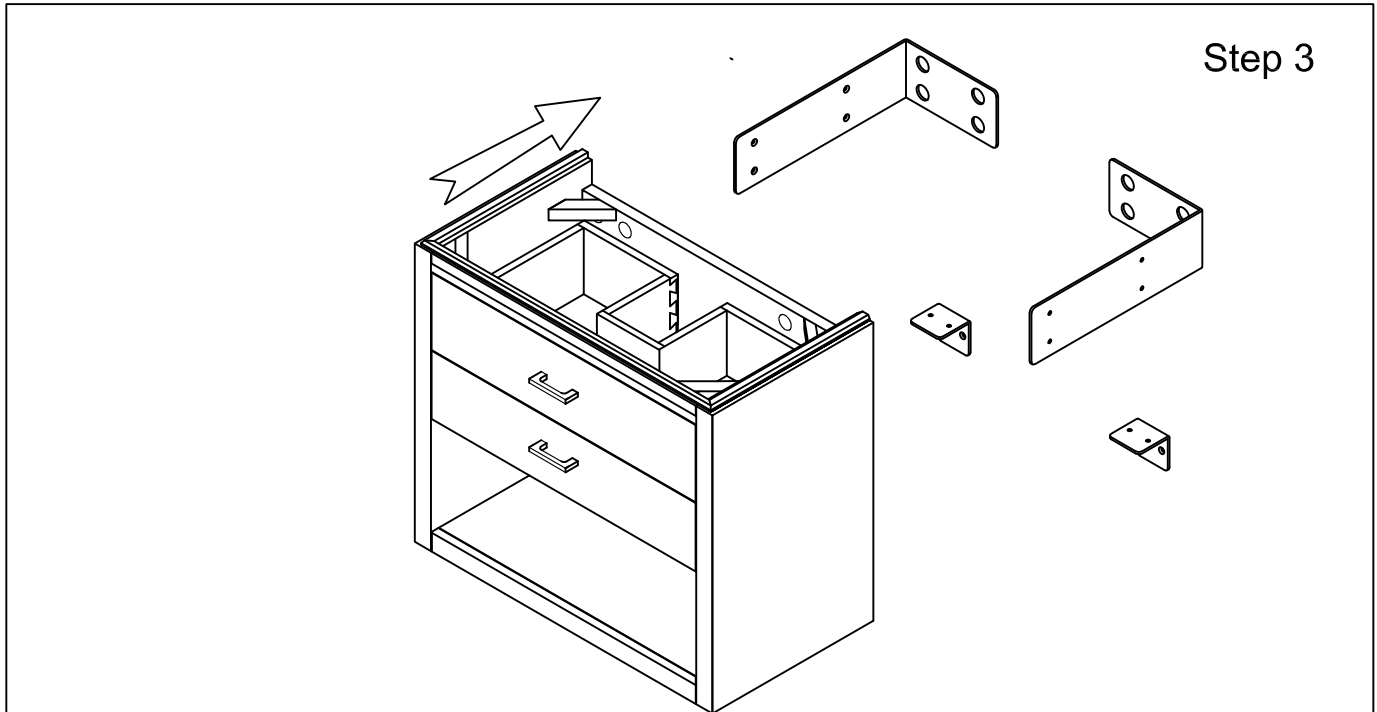

Fairmont Designs highly recommends that you seek a professional installation specialist if you are unsure of installation. Please note: Fairmont Designs is not responsible for any installation error, damages or injuries, actual or consequential resulting from possible printing error in instruction