

Charter

ADA CUSTOM OPTIONS

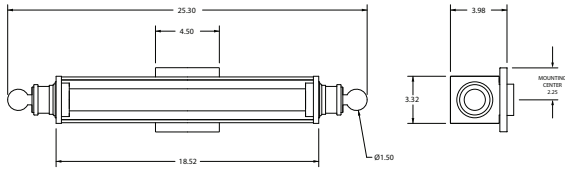

The Charter sconce delivers energy efficient LED lighting in a traditional form with full dimmability. The refined aesthetic enables the Charter to fit beautifully within a variety of designed spaces.

DIMENSIONS

25.30"H x 4.50"W x 3.98"P

LAMPING / VOLTAGE

[1] 21W LED Strip, 1512 Lumens (Nominal),
3000K, 120V, ELV Dimming

FINISH

Satin Brass, Brushed Nickel, Polished Nickel,
Polished Chrome

DIFFUSER

Clear Glass with Shiny Opal Acrylic

Customize this fixture to your specific needs



Finish shown: Polished Nickel



Fixture can be mounted VERTICALLY or HORIZONTALLY



AYRE Lighting Group, Inc.
14 Bristol Drive, Unit B
South Easton, MA 02375

Tel 508.205.0545
Toll Free 877.722.AYRE
Fax 508.205.0548

ayrelight.com

Charter

ADA CUSTOM OPTIONS

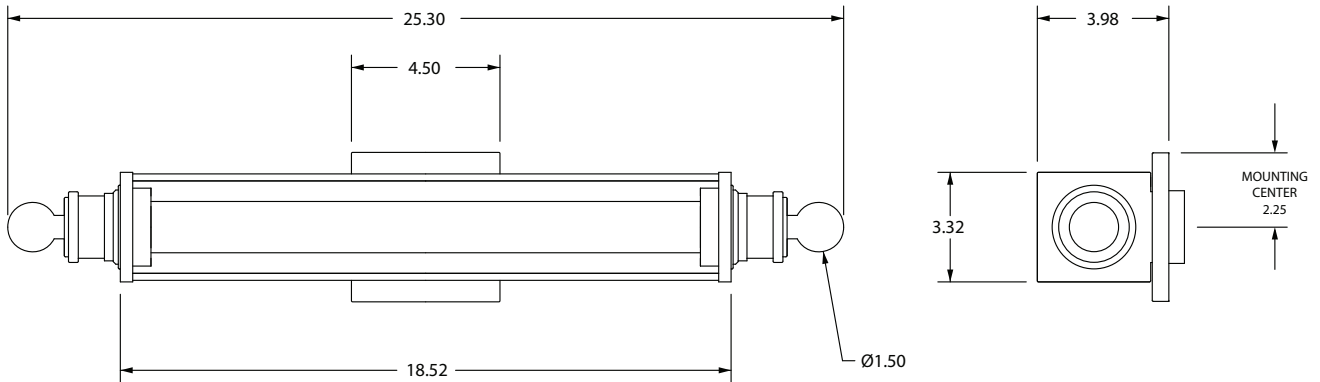

Fixture can be mounted VERTICALLY or HORIZONTALLY

Est. Weight: 8.50 lbs

MODEL
CHARTER SCONCE // CHA1

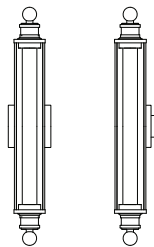

DIMENSIONS
Height: 25.30
Width: 4.50
Projection: 3.98

FIXTURE TYPE
ADA Sconce / A

DIFFUSER
Clear Glass / CL with
Shiny Opal Acrylic / SA

FINISH
Satin Brass / SB
Brushed Nickel / BN
Polished Nickel / PN
Polished Chrome / CH

LAMPING / VOLTAGE
LED / LED
[1] 21W LED Strip Module,
120V, ELV Dimming
*See Installation Instructions for
recommended LED dimmers



RELATED PRODUCTS

PORTER SCONCE // POR1

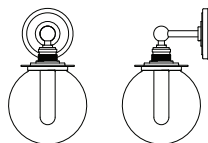

STUDIO SCONCE // STU1
ADA

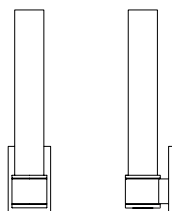

CIRC DUO R // CIRDR
ADA

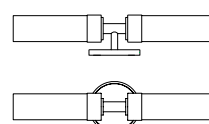

CIRC PENDANT // CIRP

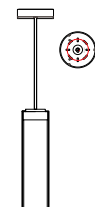

AYRE Lighting Group, Inc.
14 Bristol Drive, Unit B
South Easton, MA 02375

Tel 508.205.0545
Toll Free 877.722.AYRE
info@ayrelight.com

ayrelight.com