

# MONARCH 6031

60" x 31" x 20"

Monarch is a refined collection of therapeutic baths with distinctive deck surfaces, for a look that's noble and pure. The Collection offers luxurious bathtubs: the Monarch Grand Luxury models, featuring splendid One-piece Quartz deck.

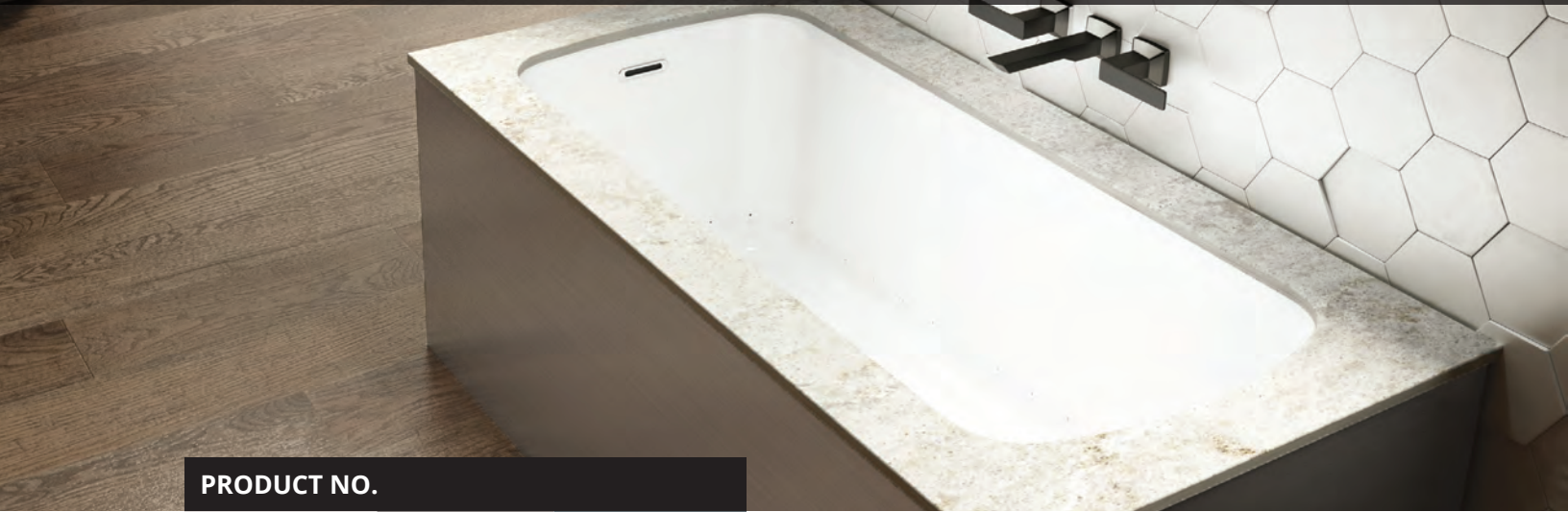





## PRODUCT NO.





DESCRIPTION	TMU	TUB
Standard (S)*	BMOCRB00T-XX	BMOCRB00N-XX
Grand Luxury (GL)*	BMLCRB00T-XX	BMLCRB00N-XX

THERMOMASSEUR (TMU) Hydro-thermo massage + Air jet system	S \$	GL \$
Jets		37
1 heated backrest		Included
MiaPlus® Control (not installed)		Included
Geysair®		Included
AromaCloud®		N/A
Illuzio Chromatherapy BCHRO6		\$

TUB Soaker	S \$	GL \$
AromaCloud®		N/A
Illuzio Chromatherapy BCHRO6		\$
WarmTouchShell® BWTS		\$
DOT control		Included with therapy

FEATURES			
Installation type		Drop-in & Alcove (3 walls)	
No. of bathers	50	Imp. gallons	42
US gallons	50		
INTEGRATED WASTE & OVERFLOW BOVERINI-XX			
White 01, Chrome 07, Brushed Nickel 09, Polished Nickel 10		Inst. & Incl.	
STANDARD COLOR (inner shell)			
 White 01		Included	
QUARTZ DECK COLOR		S*	GL*
		BDMO6031-XX	BDML6031-XX
 Grey Expo 21	 Noka 22	 Jet Black 23	 Lagos Blue 24
		Included	Included

## OPTIONS (UPCHARGE APPLICABLE)

QUARTZ DECK COLOR	S*	GL*
	BDMO6031-XX	BDML6031-XX
 Quasar Light 25	\$	\$
   Piatra Grey 26, Bianco Drift 31, Woodlands 30	\$	\$
 Statuario Maximus 29	\$	\$
FINISH (inner shell)		
UltraVelour Matte Finish (White only) BVEL		\$
INTEGRATED WASTE & OVERFLOW BOVERINI-XX		
Matte Black 19, Black Chrome 12, Satin Brass 18		\$
WASTE & OVERFLOW 16" x 35" BOVER16-XX		
Chrome 07		\$
White 01		\$
Brushed Nickel 09, Polished Nickel 10, Oil-rubbed Bronze 11		\$
QUARTZ SKIRT 6018 (60" x 18 7/8") BSM6018-XX		
Grey Expo 21, Noka 22		\$
Jet Black 23, Lagos Blue 24		\$
Quasar Light 25		\$
Piatra Grey 26, Bianco Drift 31, Woodlands 30		\$
Statuario Maximus 29		\$
CONTROL (TMU only)		
MiaMulti® BMIAM2-XX		\$
TILE FLANGE (specify right or left)		
Ordered with bath (not installed) BTILEN		\$
Factory-installed. Right BTILER, Left BTILEL, Special installation BTILEO		\$
IF REQUIRED BY CONSTRUCTION CODE OR INSTALLED WITH ITD		
Brass waste & overflow kit** BDRCOB		\$
Brass waste kit** BDRCB		\$
16" x 35" Cable driven Brass waste & overflow kit BOVERBR-XX		\$



**MONARCH 6031**



Jet Black with quartz skirt 6018

**INSTALLATION**

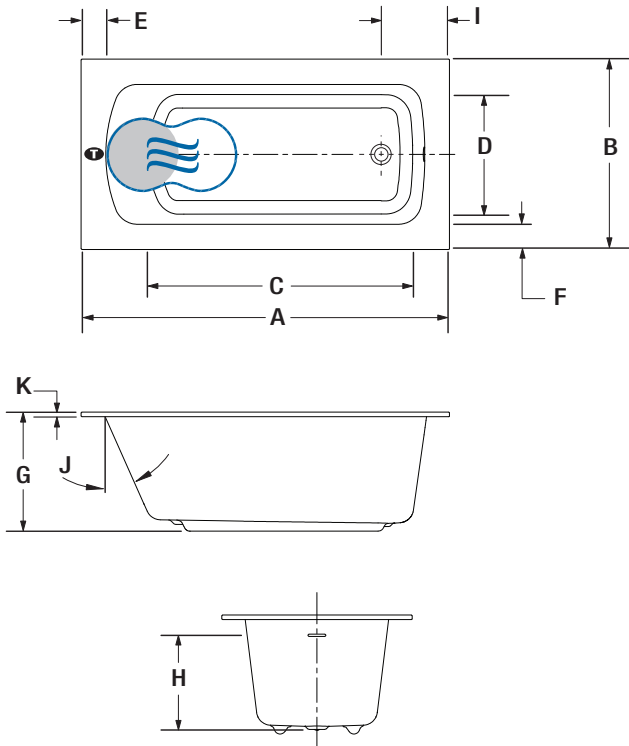

LETTER	DESCRIPTION	MEASURE
A	Total length	60"
B	Total width	31"
C	Bathing well length (at height of jets)	43 5/8"
D	Bathing well width (at height of jets)	19 5/8"
E	Deck width (edges)	4"
F	Deck width (sides)	4 1/8"
G	TUB height	19 7/8"
H	Height from waste to center of overflow	15 3/8"
I	Outside edge to center waste	11 1/8"
J	Slope of backrest	24°
K	Quartz deck height	3/4"

- Turbine position (TMU)
- Indicates heated backrest (TMU)
- Indicates WarmTouchShell® position (TUB)

Don't forget that this model is available in **White only with choice of deck color**. Don't forget to specify the **finish of the integrated waste & overflow**.  
 \* Standard: Quartz deck with seam. Grand Luxury: one piece Quartz deck.  
 \*\* When ordered with integrated waste & overflow.

**TOTAL PRICE**      \$

**TECHNICAL SPECIFICATIONS**

<b>Hot water supply required</b>	Should be 70% of water capacity of TUB or greater.
<b>Turbine</b>	Access to the pump must be at least 18" x 22". <b>Standard connection is 20 A, 120 V, 60 hz</b> , dedicated line with a Ground-Fault Circuit Interrupter (GFCI). <b>For any additional option, a second line is needed 15 A, 120 V, 60 hz</b> , dedicated line with a GFCI.
<b>Other</b>	Control cannot be installed on the Quartz deck.

Our products must be installed by certified professionals only and according to our Monarch Installation Manual as well as federal, provincial/state and local building codes and regulations ([www.bainultra.com/documentation/documentation](http://www.bainultra.com/documentation/documentation)).

<b>Approx. shipping weight</b>	230 lbs
<b>Turbine power</b>	550 W
<b>Air heater</b>	600 W
<b>WARRANTY</b>	
Controls-LED-Geysair*	5 years
Quartz deck*	15 years
Bath & turbine*	20 years

\* Some restrictions apply | [www.bainultra.com/warranty](http://www.bainultra.com/warranty)



The specifications shown indicate the outer edge dimension and the inside bathing capacity dimension measured at air jets' height. The manufacturer accepts a 1/4" [0.64 cm] variance. There are variations on each product and specifications are subject to change as we improve upon our product as required. The dimensions needed for site preparation and structure building will differ. BainUltra® assumes no responsibility for preparatory work done prior to the product being on site.