

INSTALLATION INSTRUCTIONS

Downtown Contempo Widespread Faucets Part #'s: 8882-****, 8883-***



8882



8883

Handle Options



Handle Options



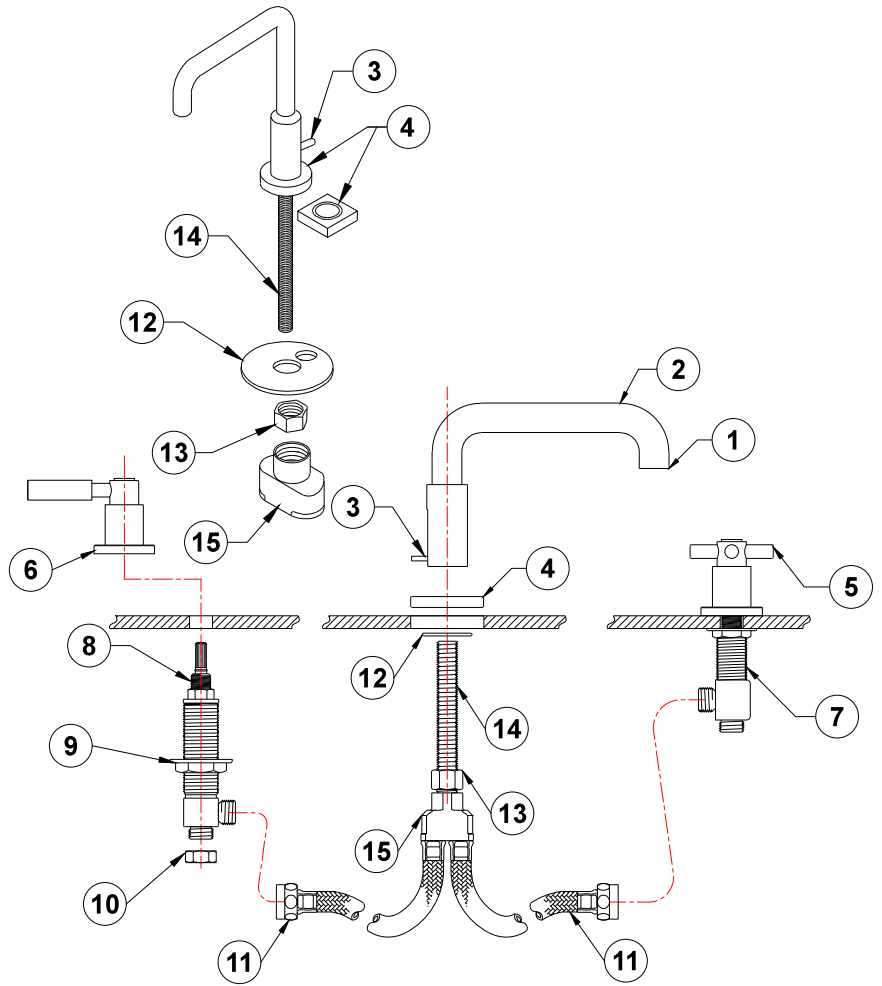
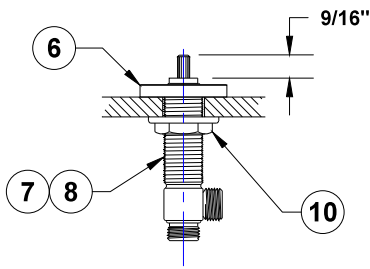

COMPONENT PARTS	
1	Hidden Aerator - 9880-AER
2	8882 Low Profile Spout - 8882-SPOUT-LL-** / 8883-SPOUT-LL-**
3	Lift Rod - 9880-ROD-**
4	Round or Square Spout Escutcheon - VARIES ON MODEL
5	Handles - VARIES ON MODEL
6	Round or Square Valve Escutcheon - VARIES ON MODEL
7	Valve Body Cold - 11833-0 OR 11835-0 (FOR L & C HANDLE ONLY)
8	Valve Body Hot - 11832-0 OR 11834-0 (FOR L & C HANDLE ONLY)
9	Valve Body Nut (2)
10	Nut - A438-0
11	Hose (2) - 5130-0
12	Washer - PART OF SPOUT
13	Brass Nut - PART OF SPOUT
14	Brass Nipple - PART OF SPOUT
15	Brass Tee - PART OF SPOUT

Spout Installation

Note: Some items have been pre-assembled at the factory to ensure quality and fit. Some disassembly may be required during installation.

1. Remove nut (14), washer (13) and "T" if installed from spout mounting nipple (15).
2. Slide spout assembly through counter top or basin.
3. Slide washer (13) onto spout nipple install nut (14) onto spout nipple and secure spout onto counter top or basin once positioned correctly.
4. Install "T" (16) onto nipple (15) using a NSF listed joint compound.

FIGURE 1

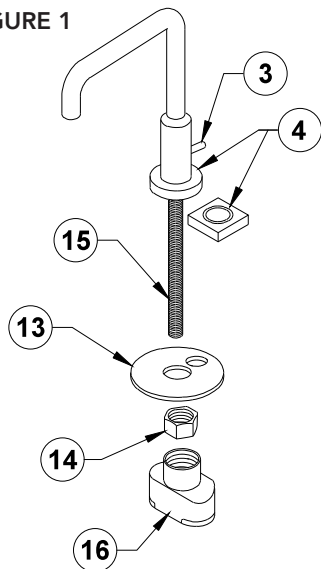
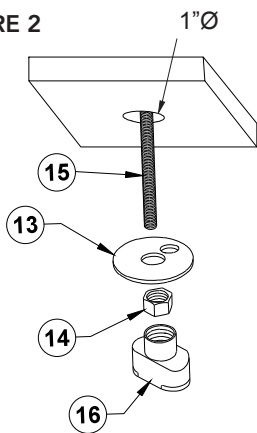

FIGURE 2



Valve Installation

1. Identify hot and cold valves. Hot has red ring and cold has blue ring.
2. Install hot valve on left side of spout when facing sink. **Figure 3.**
3. Install cold valve on right side of spout when facing sink. **Figure 3.**
4. Remove handle, escutcheon, and top valve nut.
5. Adjust lower valve nut (10) down away from valve stem. **Figure 4.**
6. Place fiber washer (9) on top of nut.
7. Find handle/escutcheon "A" dimension. **Figure 5.**
8. Thread nut up towards stem so distance from top of fiber washer to top of valve stem = "A" dimension + counter or basin thickness.
9. Install valve through bottom of counter or basin. **Figure 4.**
10. Install top nut and escutcheon on to valve and tighten. *Note: not all handle/escutcheon combinations use a top nut. **Figure 5.**
11. Confirm "A" dimension for faucet model installed. Adjust if necessary.

FIGURE 3

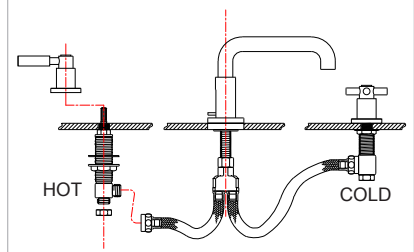
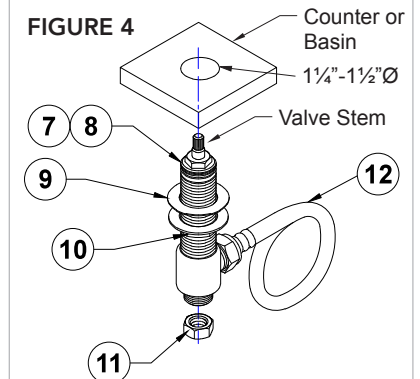

FIGURE 4



Hose Installation

1. Connect hot hose to hot valve outlet and "T". **Figure 3.**
2. Connect cold hose to cold valve outlet and "T". **Figure 3.**
3. Connect supply hoses or tubes (not supplied) to base of hot and cold valves. **Figure 4.**

Aerator Cleaning ALWAYS REMOVE AERATOR AND FLUSH THE FAUCET AFTER INITIAL INSTALLATION

1. Use aerator key supplied with faucet
2. Engage key in aerator. **Figure 1.**
3. Remove aerator by turning key counterclockwise
4. Turn on hot and cold water valves flush lines
5. Reinstall aerator by engaging key and turning clockwise until tight
6. Check for leaks, re-tighten if necessary

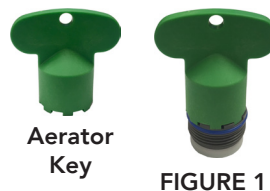

*No top nut used on any of these handles

FIGURE 5

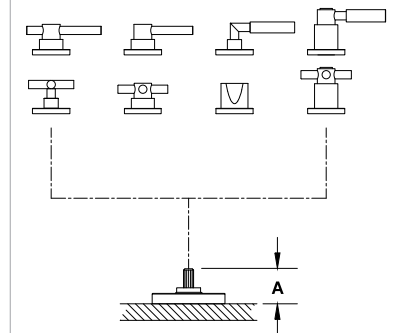

Handle Installation

1. Install handle onto stem in desired "off" position.
2. Confirm handle is not binding with escutcheon. Adjust valve nuts and escutcheon if necessary.
3. Handles are fastened with a set screw or top screw. **Figure 6.**
4. If set screw type, install washer and screw, tighten then press in decorative cap with o-ring.
5. If top screw type, install washer and screw, tighten then press in decorative cap with o-ring.

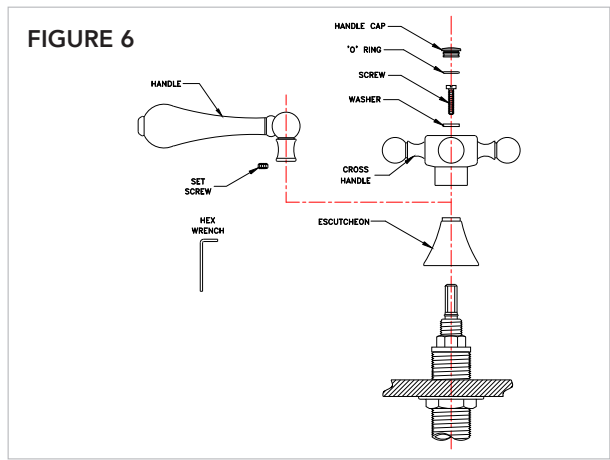

Drain Assembly

1. Slip the top gasket (3) over the drain tube (2).
2. Place drain tube through hole in basin.
3. Install bottom gasket (4), mounting washer (5) and mounting nut (6) onto drain tube. Tighten using basin wrench.
4. Place tube washer (13) into drain body (14) and tighten into drain tube, positioning side port toward the back of basin.
5. Wrap the threads of the tail tube (7) with two layers of teflon tape and thread into drain body.
6. Insert drain plug (1) into drain tube. **Note: Drain plug style may vary**
7. Insert ball rod seat (8) into side port of drain body, carefully insert ball rod (15) through the hole provided in drain plug.
8. Thread ball rod nut (9) onto drain body and tighten until snug. **DO NOT OVER TIGHTEN**
9. With the lift rod in position on the spout, insert the end into the lift rod strap (10) as shown.
10. Slide the other end of the lift rod strap onto ball rod, using the spring clip (12) as shown.
11. Push the ball rod down to put drain plug in full open position and adjust the lift rod height so that the knob rests on top of the spout.
12. Tighten lift rod strap screw (11) using the adjustable wrench.

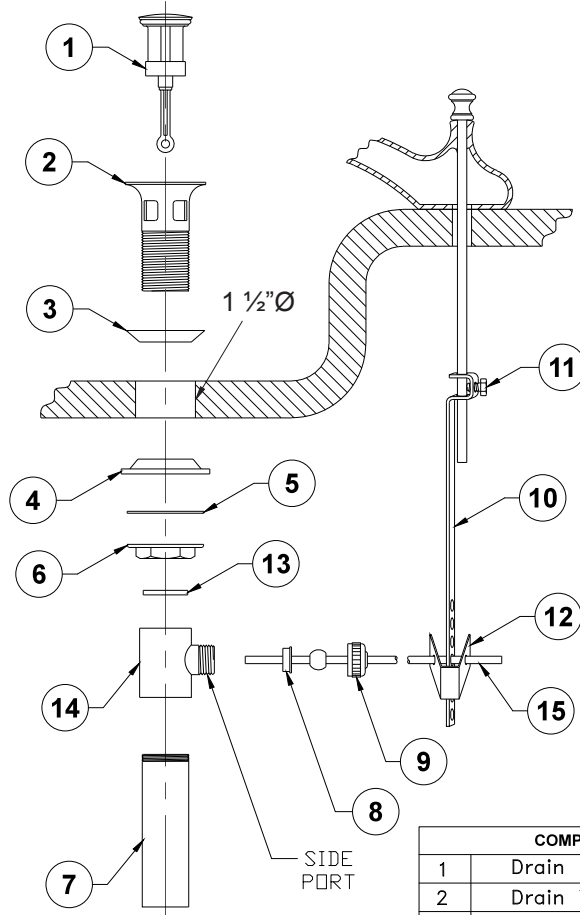

COMPONENT PARTS	
1	Drain Plug
2	Drain Tube
3	Top Gasket
4	Bottom Gasket
5	Mounting Washer
6	Mounting Nut
7	Tail Tube
8	Ball Rod Seat
9	Ball Rod Nut
10	Lift Rod Strap
11	Lift Rod Strap Screw
12	Spring Clip
13	Tube Washer
14	Drain Body
15	Ball Rod

CARE INSTRUCTIONS

In order to maintain the high quality finish of JACLO products, please adhere to the following product care instructions:

Cleaning JACLO products: For routine cleaning, simply use a soft damp cloth and common household soap, then rinse and dry. Proper care of your product is important because most water contains calcium that deposits on surfaces, forming unpleasant spots. This can be avoided by routine cleaning and drying after every use. Use only mild soap based detergents.

Never use abrasive cleaners, bleach, disinfectants or cleaning products containing alcohol, ammonia, hydrochloric or phosphoric acids as they will damage the product finish.

Please note: Your product warranty may not be valid if the above cleaning guidelines are not followed.

The use of water softeners, which are loaded with salt, will destroy any finish in time. Use of water softeners void all warranties.

WARRANTY

Residential Warranty: Your new plumbing fixture is warranted by **JACLO INDUSTRIES**, 129 Dermody Street, Cranford, NJ 07016. This warranty is extended to original consumer purchasers only. This warranty gives you specific legal rights, and you may also have other rights which vary from state to state.

The product (including the finish on the product but excluding any custom finishes and any installation hardware not supplied by JACLO) is warranted to be free from defects in material or workmanship under normal use and service for the lifetime* of the fixture, so long as the original consumer purchaser owns it. JACLO's sole obligation under this or any other warranty is limited to repairing or replacing at JACLO's option, without labor, any part or parts of the fixture which fall to conform to such warranty.

JACLO WILL NOT BE LIABLE FOR ANY CONSEQUENTIAL OR INCIDENTAL DAMAGES CAUSED BY A BREACH OF THIS OR ANY OTHER WARRANTY.

Some states do not allow the exclusion of limitation of incidental or consequential damages, so the above limitation may not apply to you.

To secure warranty performance, the original consumer purchaser must have the fixture properly and professionally installed in accordance with all codes and installation instructions.

Items and actions that will void the JACLO warranty are:

- Abuse, misuse, neglect and accidental damage
- Improper cleaning care of maintenance of the fixture
- Alteration of the fixture in any way including removal of a flow regulator/restrictor

All warranty claims must be made in accordance with the JACLO return policy (see below).

JACLO does not authorize any distributor, retailer or other person to modify this warranty or assume any liability on its behalf with respect to it. Any question regarding the operation of warranty should be addressed to JACLO's warranty department.

*Due to the unpredictable environment, all kitchen drains, strainers and garbage disposal flanges are warranted for the period of one year from date of purchase from an authorized JACLO dealer

Commercial Warranty: JACLO extends the above warranty for a period of one year from date of purchase to purchasers of products for industrial, commercial, business and all non-private residential uses.