



VINCENT 3-HOLE WIDESPREAD LAVATORY FAUCET

Vincent (Transitional Bath)

A1008LV

FEATURES

- Metal levers
- Fixed spout
- 8" centers
- 3 x 1 3/8" cutout
- 1/4-turn ceramic valves
- 1/2" NPT connectors
- Pop-up included
- Matching tub filler A1004LV or A1084LV
- 1.2 GPM

COLORS/FINISHES

- Polished Chrome
- Polished Nickel
- Satin Nickel

WARRANTY

- Limited Lifetime*

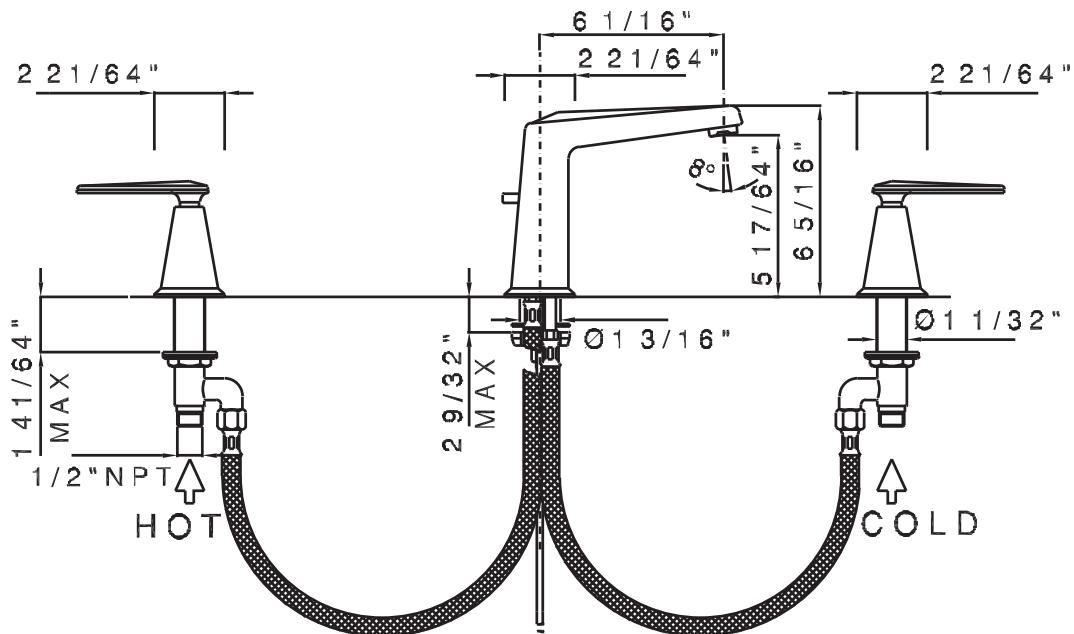

Consult your local ROHL showroom for additional information and specifications. For complete warranty details and a list of showrooms, go to www.rohlhome.com.

A1008LV Spare Parts

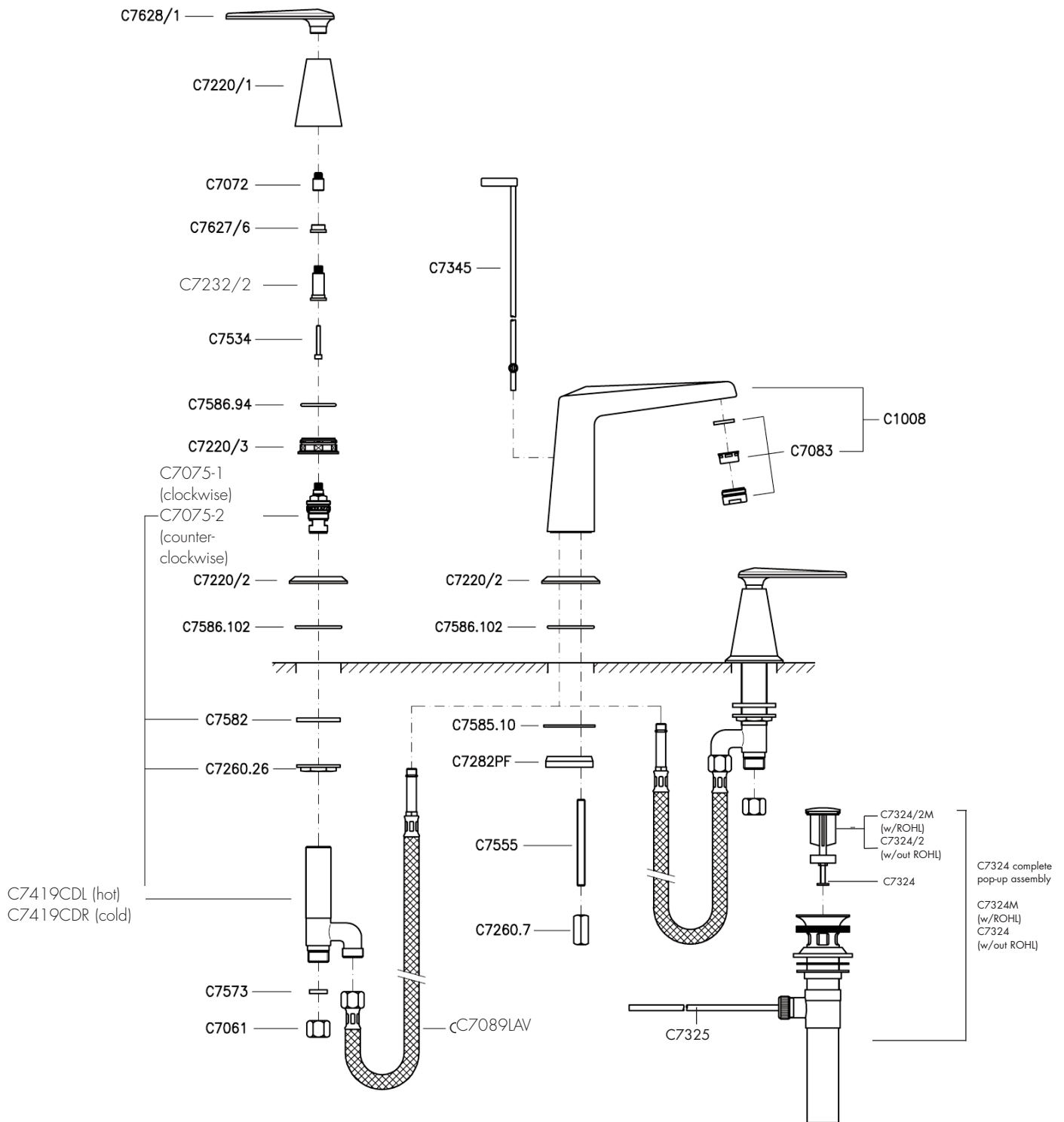

Consult your local ROHL showroom for additional information and specifications. For complete warranty details and a list of showrooms, go to www.rohlhome.com.

Installation Instructions

INSTALLATION AND CARE & MAINTENANCE GUIDE Installation guide

Wash basin mixer with automatic pop-up waste
Art. A1008LV-- -2

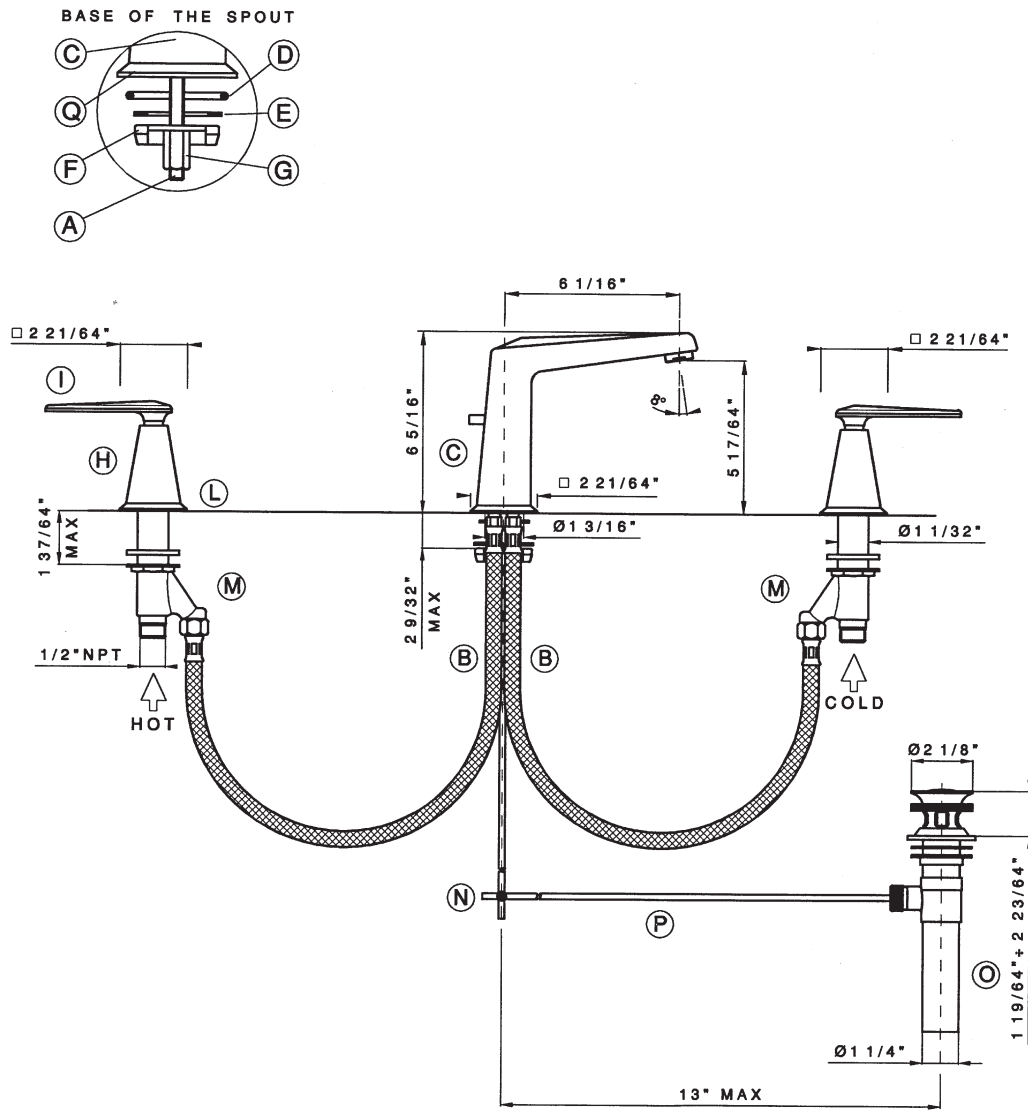

Installation Instructions

INSTALLATION AND CARE & MAINTENANCE GUIDE

Installation guide

a - Preparation

Flush out the pipework to remove any foreign matter.

The hot supply should be on the left when viewed from the front of the fitting.

b - Assembly

- Assemble the threaded pivot (A) and the flexible hoses (B) at the spout (C).
- Introduce the spout (C) in the central hole of the wash basin, first placing the square disc (Q) and then the O-Ring (D) between the square disc (Q) and the wash basin.
- Fix the spout (C) location, before the shaped rubber washer (E) and then the half-moon plate (F) and the lengthen nut (G).
- Assemble the valve body (M) and the handle set (I) following the instructions below :

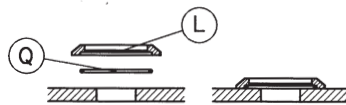

Place O-Ring (Q) and square disc (L) on the desk.

HEXAGONAL NUT SETUP LINE

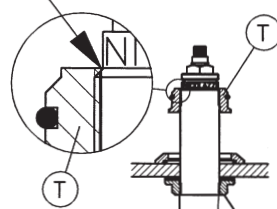

Insert the valve body (M) in the basin hole, first placing the washer (R) and then the hexagonal brass fixing nut (S).

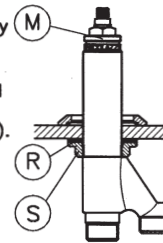

Screw the upper hexagonal nut (T) making sure to place it at the end of the body's thread (HEXAGONAL NUT SETUP LINE).

Alternative possible assembling is:
Mark the side valve between 1 5/8" and 1 3/4" from the top of the stem with marker.
Spin the upper deck nut down to the mark.

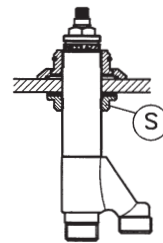

Place (L) the square disc in the right position before screwing the underside hexagonal brass fixing nut (S).

ATTENTION

Maximum fixing nut torque value = 10 lbf.ft.

Tighten the trim cap (H) and square disc (L) snugly so cap (H) is in proper alignment with square disc (L) on the deck. Tighten hexagonal brass fixing nut (S) under the deck the secure the valve body (M) into the final assembled position. This final adjustment may take a few attempts for the installer to achieve the proper alignment and height of all components depending on the thickness of the deck.

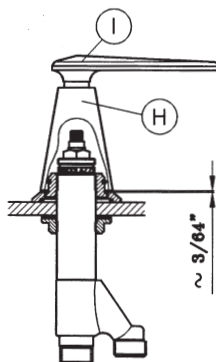

Assemble the handle set (I) screwing the cap (H), placing it in the correct position.

ATTENTION

be sure that the handle has no play.
Please verify the distance (3/64").
The square disc (L) and the cap (H) must not be in contact.

Installation Instructions

b – Assembly (continued)

- Repeat this procedure for the cold valve.
- Connect the side valves (M) to the nozzle using the flexible hoses (B).
- Unscrew the knob from the rod (N) before introducing it in the bottom of the spout (C).
Screw the knob already in place to the rod.
- Assemble the automatic pop-up waste (O). Introduce and fix it in the drain hole of the wash basin.
Join the vertical rod (N) to the horizontal rod (P) using the double connector.
- Connect hot and cold water supplies to side valve inlet.
- Ensure all connections are firmly tightened.

c – Before use

Turn on the Hot and Cold supplies to the faucet.
Maximum temperature for Hot water supply to the faucet is 145° F.
Minimum recommended pressure is 15 psi – Maximum recommended pressure is 75 psi.
Check the installation carefully for leaks.
If further building work is to be carried out in the vicinity of the faucet, it should be covered to prevent paint, adhesive, etc. from damaging the surface.

Care and use for finishes

Country Bath Products are all authentic finishes that have not been coated with any product.

After each use, pat the fixture down to remove any excess water. This will prevent any water spotting or mineral build-up. Use only soft liquid soap and water to clean the surface. Use a soft brush to clean any gaps. Avoid any products that have ammonia or alcohol like Windex, 409 or Fantastik. These products can damage the finish leaving black or white spots. Never use an abrasive product like Softscrub, Comet, Ajax or Bon Ami.

For deep polishing we recommend Bruno's Wax for all finishings.

Tuscan Brass is a living finish and has no warranty. It will lighten with use. To extend the life of the finish, apply Bruno's Wax by patting it on, letting it dry and patting it off. Never rub or buff this finish.

WARNING: the use of cleaning products not recommended might irreparably harm the surfaces of the faucets which in such case are not covered by our warranty.

Limescale

The faucet is fitted with an aeration device in the Hot/Cold water outlet.

This may need occasional cleaning especially in hard water areas.

This is accomplished by unscrewing the outlet in a counter clockwise direction, dismantling and leaving the inner screen mesh immersed over night in vinegar or lemon juice.

Do not use chemical descaling liquids for this purpose.

Installation Instructions

ATTENTION

READ THESE INSTRUCTIONS BEFORE INSTALLATION AND USE OF ALL FAUCETS AND WALL VALVES

INSTALLATION and WARRANTY INSTRUCTIONS TECHNICAL INFORMATION

All flexible hoses are designed and manufactured for use with water in exposed locations only. **Do not expose** to household cleaners, chlorine, chloride, hydrochloric acid or other corrosive chemicals.

- All connections with threads M10x1 male must be hand tighten. **Do not over tighten. Over tightening may cause damage to the hose.**

All faucets washers and o-rings are designed and manufactured for use with water. **Do not expose** to household cleaners, chlorine, chloride, hydrochloric acid or other corrosive chemicals.

Faucets are designed for use with the temperatures and pressures listed below:

- minimum cold water supply 50 °F
- maximum hot water supply 145 °F
- minimum pressure 15 psi
- maximum pressure 75 psi
- maximum fixing torque value = 10 lbf.ft.
-

Please note: The recommended best pressure for best performance is between 40 psi and 60 psi. More pressure than 60 psi or less pressure than 40 psi may affect the diverting action in side spray faucets.

- Do not use any Rohl Country/ Nicolazzi faucet with sulphorous water.
- The minimum temperature for all faucets is 50 degrees F. Below 50 degrees F will void the warranty.
- When available, filter systems must be placed between hot and cold supply lines and the faucet. Improper use or non-use of filters may make diverting faucets with hand sprays perform poorly.
- Don't modify faucet and their components
- Use only original spare parts if there are replacements to be ordered.
- Installation must be made by authorized plumbers or installers. Improper installation or diagnosis of problems is not covered by the warranty.
- Yearly maintenance of cleaning and flushing is recommended.

Operation and use of any faucet or wall valve that do not conform to these technical instructions will void the warranty.