

OWNER'S MANUAL BOUTIQUES

INSTALLATION • OPERATION MAINTENANCE
BATHTUB / SHOWER REPAIR
WHIRLPOOL • MASS-AIR • ACTIV-AIR • TONIC
FREESTANDING BATHTUB INSTALLATION



Produits Neptune

produitsneptune.com

Do not discard. Save these instructions for further use

Table of contents

INTRODUCTION

Important safety instructions.....	3
Summary of precautions.....	3

INSTALLATION

Bathtub installation: Before you begin.....	3
Required tools.....	3
Materials required.....	3
Site preparation.....	4
Protective foam packaging.....	4
Recessed installation.....	4
Tiling flange on bathtub and shower base.....	5
Podium installation.....	6
Undermount bathtub installation.....	7
Installation of bathtubs with contour skirt.....	7
Faucet installation.....	8
ULTIM-O and Kara drain assembly.....	8
Wish bathtub and drain installation.....	9
System hook-up (electrical installation).....	9
Finishing walls, decks and podiums.....	30
Optional bathtub skirt installation.....	30
Fixed height skirts.....	30
Adjustable height skirts.....	31
Thalassa skirt installation.....	31
Shower and shower base installation.....	38

OPERATING INSTRUCTIONS

Ozonator.....	29
Whirlpool or Chromotherapy On/Off control.....	32
Whirlpool and Chromotherapy On/Off control.....	32
Mass-Air, Activ-Air and Combo control.....	32
Whirlpool: Adjustable jets.....	36
Whirlpool: Air induction.....	36
Backjets: Diverter valve (option).....	36
Tonic controls.....	37

MAINTENANCE

Routine cleaning.....	40
Mass-Air and Activ-Air systems.....	40
Whirlpool maintenance.....	40
Maxima jet.....	40

ACRYLIC REPAIRS

Stains.....	40
Minor scratch repair.....	40
Major damage repair.....	40

TROUBLESHOOTING

Important information to safeguard.....	41
---	----

WARRANTY.....	42
---------------	----

Thank you for selecting a Produits Neptune product. Your trust plays a great part in this company's success.

Your new Produits Neptune bathtub / shower is a top of the line product that will give you years of pleasure and relaxation if it is installed and maintained correctly.

We encourage you to read and understand all of the safety, installation and maintenance instructions included in this owner's manual. It is strongly recommended that the installation of your bathtub / shower be carried out by qualified and accredited professionals in accordance with governmental building codes and by-laws.

Installation

BATHTUB INSTALLATION: BEFORE YOU BEGIN

Before you begin the installation of your new Produits Neptune bathtub it is strongly suggested that you do the following:

- Inspect your bathtub visually to make sure that it has not been damaged during transportation. If you suspect that there may be damage do not install the bathtub.
- Make sure that the bathtub is the unit that you ordered and that its dimensions and drain-side correspond to your plans.
- Never use the pump, piping or jets to lift or manipulate your bathtub, as this can damage both the equipment and the watertight connections of the bathtub.
- The bathtub should be placed in the bathroom. Make sure the floor is leveled and solid enough to support the weight of the bathtub when it is full (1000 lbs average). The feet of the bathtub must be in contact with the floor. It cannot be suspended by the perimeter alone.
- For optional non-adjustable skirt installation, the bathtub must be installed at the correct height to facilitate the installation of the skirt (see table 1 for height information).
- An access panel is mandatory. Most building codes require that there be an access panel a minimum of 30 cm x 55 cm (12" x 22") in order to service the plumbing, motor, control unit and keypad.
- In order to protect the bathtub during installation a piece of cardboard should be cut out of the box and placed in the bottom of the bathtub.
- If there is a protective plastic sheet covering the surface of your bathtub, it should not be removed until the installation is complete. When necessary during the installation process the plastic can be peeled back to install the drain, overflow and surface mounted plumbing fixtures. The plastic should

also be peeled back in areas where it could become snagged during the installation process.

- Do not sit on the edge of the bathtub.
- If your bathtub is equipped with a Whirlpool, Mass-Air, Activ-Air or Tonic system you must test it before final installation. These systems are tested at the factory but can be loosened by transportation and installation.
- Remember that the Whirlpool, Mass-Air, Activ-Air and Tonic systems must be hooked-up before the final installation.
- If your bathtub is equipped with adjustable metal feet they should be installed now by threading them into the metal support rails underneath the bathtub.

REQUIRED TOOLS

- Level
- Hole-saw (for surface mount faucet installation)
- Jigsaw for podium installation
- Safety glasses
- Tape measure
- Caulking gun

MATERIALS REQUIRED

- Bathroom grade (mildew resistant) silicone caulking
- Construction adhesive
- Adjustment shims (except for bathtubs equipped with adjustable feet)
- 1" X 2" Wood strip for attachment to the walls
- 2" X 3" Wood stock for building podium or apron
- 5/8" Exterior grade plywood for covering podium or apron
- No. 8 x 1 1/4" wood screws
- Bathtub drain and overflow kit (available from your Produits Neptune dealer)
- Mortar (optional mortar bed installation only)

IMPORTANT SAFETY INSTRUCTIONS

 **WARNING: When using this unit and any electrical product, basic precautions should always be followed, including the following:**

 **DANGER: Risk of electric shock.** This unit must be connected only to a circuit that is protected by a class-A ground fault circuit interrupter (GFCI). Grounding is required, this unit should be installed by a qualified service representative and grounded. Install to permit access for servicing.

 **WARNING: Risk of electric shock.** A licensed electrician should make all electrical connections.

 **WARNING: Risk of electric shock.** Disconnect power before servicing.

 **WARNING: Risk of injury or property damage.** Please read and understand all instructions thoroughly before beginning installation, including the following requirements.

- Follow all local plumbing and electrical codes.
- Provide unrestricted access to the pump. Access must be provided for servicing the pump and controls. The access must be located immediately next to the pump.

 **WARNING: Unauthorized modification may cause unsafe operation and poor performance of the Whirlpool, Mass-Air and Activ-Air systems.** Produits Neptune shall not be liable under its warranty or otherwise for personal injury or damage caused by any such unauthorized modification.

 **WARNING: Risk of child drowning.** To reduce the risk of accidental drowning, do not permit children to use the bathtub unless they are closely supervised.

SUMMARY OF PRECAUTIONS

The following precautions should always be taken:

- The suction cover must be in place at all times to minimize the potential for hair and body entrapment.
- Keep body and hair a minimum of 15cm (6") away from the suction fitting at all times when the whirlpool system is operating. Hair longer than shoulder length should be secured close to the head.
- Never operate electrical appliances (telephone, television, radio, hairdryer etc.) inside or within 1.5m (5 ft) of the bathtub.
- Never leave small children unattended in the bathtub.
- Do not operate the whirlpool system unless the bathtub is filled with water to at least 5cm (2") above the highest jet.
- When cleaning your bathtub, do not use abrasive substances that will damage the bathtubs' surface.
- A maximum water temperature of 104° F (40° C) is recommended. Bathing temperatures above 104° F (40° C) for prolonged periods can be injurious to health. Pregnant or possibly pregnant women should consult a physician before using a Whirlpool system.
- The Whirlpool system must be cleaned at least monthly.
- It is important to mix the essential oils with water before they are poured into the bathtub, as their improper use could cause skin irritations and damage to the surface of the bathtub. Please read the instructions carefully before use. Rinse the bath very well after each use. Essential oil is very abrasive and their utilisation is at risk of the user.

SITE PREPARATION

- The site should be cleared of debris and vacuumed. This will ensure that the bathtub is leveled properly and that no dirt can be sucked into the bathtub's systems.
- Check if the floor is leveled and solid. The level should be in a range that can be compensated for by the use of adjustment feet. An average sized bathtub can weigh as much as 450 kg (1000 lbs) when full, the floor must be able to support this weight.
- An opening of 15cm x 30cm (6" x 12") needs to be cut into the floor for the bathtub drain and overflow (see fig. 1). Make sure that there are no obstructions in this space.

Fig. 1

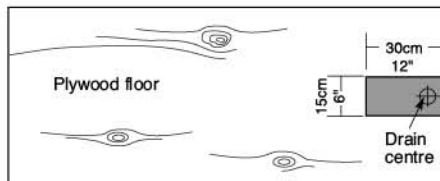

- The plumbing rough-in for both the drain and the supply lines should be completed by a competent and accredited plumber before the bathtub is moved into its final position.
- For bathtubs equipped with a Whirlpool, Mass-Air, Activ-Air, Lighting system or inline water heater, all electrical connections should be completed by a competent and accredited electrician. Each system must be hooked-up to a dedicated 15 amp ground fault circuit interrupter (GFCI) breaker, or where allowed by law to a regular breaker with a ground fault circuit interrupter (GFCI) outlet.

PROTECTIVE FOAM PACKAGING

The adjustable legs on our bathtubs are now provided with foam packaging around each leg to ensure the quality of the products during transportation. These foam protectors have to be removed before installation.



With protective foam packaging

Without protective foam packaging

RECESSED INSTALLATION

When the plans call for installation of the bathtub in a recess (i.e. encased between 2 or 3 walls) we suggest that the following installation procedure be followed:

- **Step 1:** The bathtub overflow and drain should be installed by a competent certified plumber according to the overflow manufacturers instructions, and conforming to local building codes.
- **Step 2:** The bathtub must be positioned and leveled by placing the adjustment shims under each foot. Some bathtubs are equipped with adjustable metal feet and can be leveled by turning the feet until the desired height is achieved. Level the longer part of the bathtub first by placing a long level along the edge that is against the wall (see Fig. 3). Next, level the sides by placing shims under the front feet. Make sure that the slopes of the bathtub decks that have a tiling flange lean towards the inside of the bathtub. To install the optional apron for HELENA, DAPHNE, ZORA, ZEN, and DELIGHT bathtubs, the bathtub must be installed at a specific height. Determine this height as follow:

Measure bathtub height from the finished floor* up to below the bathtub cut line (A). This measurement must be the same as the skirt height (B)** plus 1/8" (see Fig. 2).

* You must know the height of the floor covering (ceramic, hardwood, etc.) to determine this height.

** Do not take into account the full skirt measurement but rather that indicated by letter B in Figure 2.

After adjusting, make sure that the bathtub is perfectly level before continuing with installation.

Fig. 2

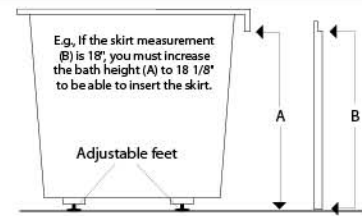

- **Step 3:** Using a pencil, mark the wall studs directly under the lip of the deck (see fig. 3). If you intend to set the bathtub in a mortar bed, the position of the feet should be marked too.

Fig. 3

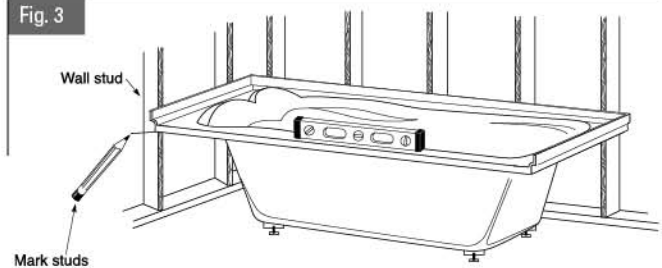

- **Step 4:** Remove the bathtub so that you have access to the walls.
- **Step 5:** Cut supports for the bathtub deck from 1" x 2" stock. The supports should be long enough to support the entire length of the bathtub. These supports are fastened to the wall studs with the top of the support at the level of the marks from step 2 (see fig. 4).

Fig. 4

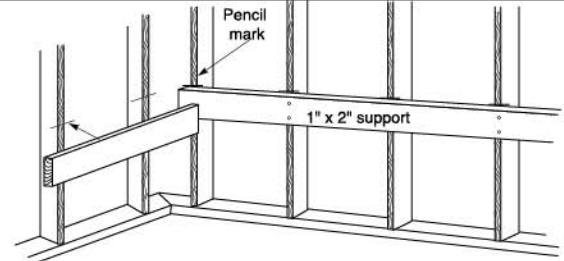

- **Step 6:** Mortar bed (optional, recommended for tub/shower installations and bathtubs with an integral skirt.) **NOTICE:** When using mortar to support a bathtub equipped with a Mass-Air or Activ-Air+ systems, the mortar should be under the feet only. Under no circumstances should the mortar come into contact with the piping and fittings underneath the bathtub. In order to protect from damage, install a plastic sheet between the tub and the mortar. Freshly mixed mortar should now be placed on the floor where the bathtub's feet will land (marked out in step 2) (see fig. 5).

Fig. 5

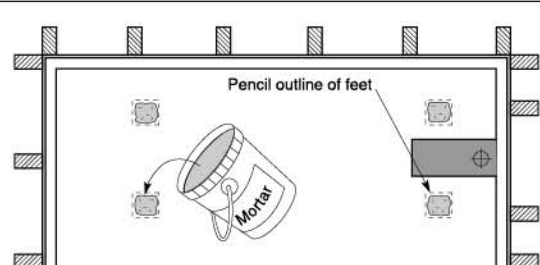

- Step 7: Apply a generous bead of construction adhesive along the top of the 1" X 2" support strips (see fig. 6). This will prevent the bathtub from shifting and also compensate for the unevenness of the fiberglass reinforcement under the deck.

Fig. 6

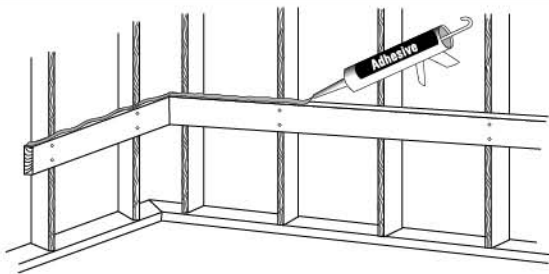

- Step 8: Set the bathtub into position. Check that the bottom of the deck comes into contact with the support strips. If you opted to use a mortar bed, check that the mortar has spread and that the feet are supported. Add more mortar if necessary. If you did not use a mortar bed, the shims should be replaced under the feet, and glued in place with construction adhesive. **Note:** Do NOT fix feet to floor using nails or screws.
- Step 9: If your bathtub is not equipped with an integral skirt the front wall should now be built. It is made from 2" x 3"s spaced 41cm (16") on center (see fig. 7). Remember to leave enough space between the top of the wall and the bottom of the bathtub deck to allow for installation of the plywood and the ceramic tile or other covering material.
- Step 10: When installation is complete (including plumbing installation), seal the bathtub onto the podium using silicone.

Fig. 7

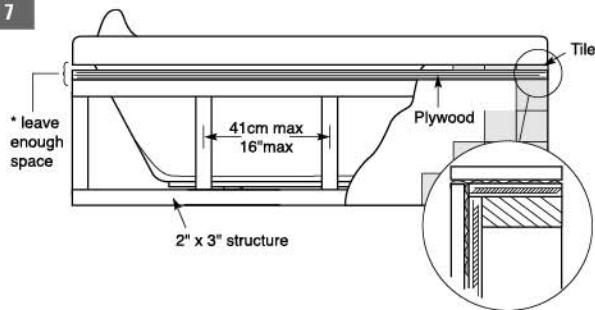
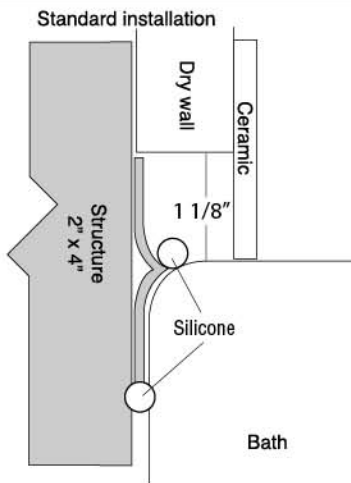

Fig. 8



TILING FLANGE ON BATHTUB AND SHOWER BASE

Although many Produits Neptune bathtubs are designed with an integral tiling flange occasionally the bathroom plans will call for the installation of a podium style bathtub between either two or three walls. In such instances it is highly recommended that a PVC tiling flange be installed. This is available as an installed option from your Produits Neptune dealer or you can add your own (optional accessory).

- **Step 1:** Measure required length of PVC tiling flange. Start measuring from 3/8" of outer edge of bathtub or shower tray. Cut using an exacto knife. (see fig. 9)

Fig. 9

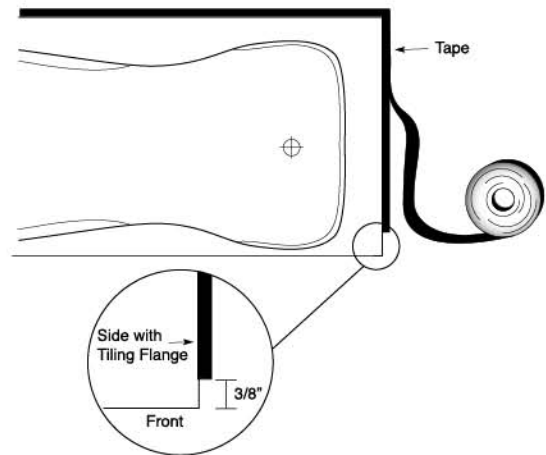

- **Step 2:** Wipe the tiling surface with a clean cloth moisten with isopropyl alcohol. Let alcohol evaporate.
- **Step 3:** Peel backing from double tape and line-up the taped edge of the tiling flange on the bathtub or shower base 3/8" from outside edge. Keep in place using tape. (see fig. 9)
- **Step 4:** Water proof the seam by applying a continuous bead of bathroom grade (mildew resistant) silicone. (see fig. 10)

Fig. 10

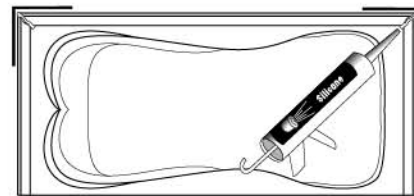

- **Step 5:** Let the silicone dry (between 12 to 24 hours).
- **Step 6:** Resume installation of your bathtub or shower base referring to fig. 8; Standard Installation.

PODIUM INSTALLATION

When the plans call for podium installation we recommend the following installation procedure:

NOTICE: The bathtub must be supported by its feet only. The feet must be in contact with the floor at all times. The rim should only touch the podium and should not be supported.

- **Step 1:** Calculate the height of your podium structure. Remember that the finish material must fit between the lip of the bathtub and the podium structure, so its thickness must be subtracted from the total height when building your structure (see fig. 11).

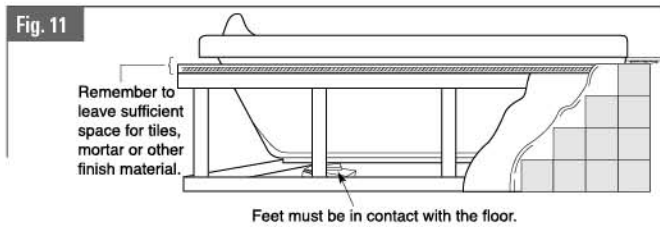

- **Step 2:** Frame the podium using 2" x 3"s spaced no more than 41cm (16") on center. Remember to provide adequate support under the rim of the tub and ensure that the framework is level. This framing must conform to your local building codes (see fig. 12).

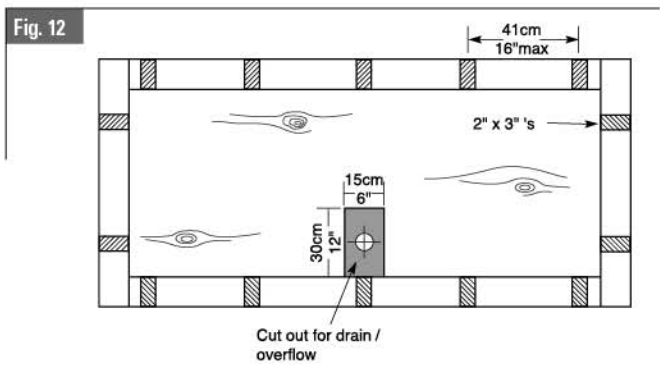

- **Step 3:** Cut out an opening 15cm x 30cm (6" x 12") in the floor to accommodate the bathtub drain and overflow piping.
- **Step 4:** Sheath the top of the podium using 5/8" thick exterior grade plywood. The plywood should be attached to the framework using screws.
- **Step 5:** Lift the bathtub onto the podium and align it in the desired position. The outline can now be traced using a level and pencil as shown in fig. 13.

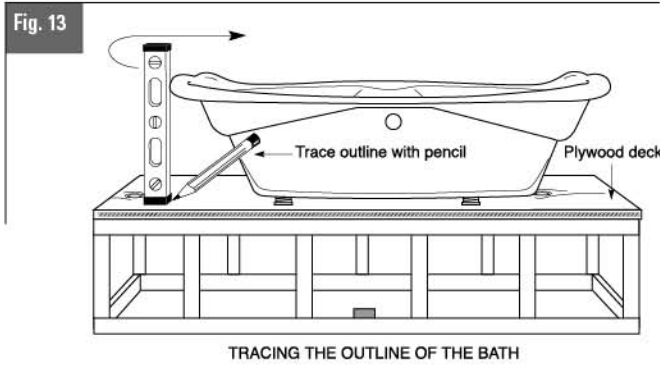

- **Step 6:** Remove the bathtub from the podium, and sketch a cut line 2.5cm (1") inside the outline of the bathtub (see fig. 14). You can use a 1" scrap of wood to simplify this procedure.

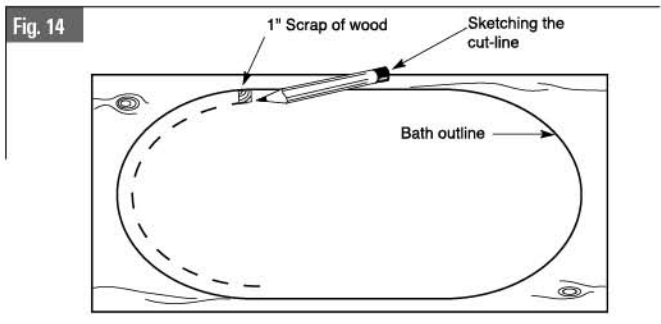

- **Step 7:** Drill a pilot hole on the cut line. Cut out the waste following the cut line using a jigsaw (see fig. 15).

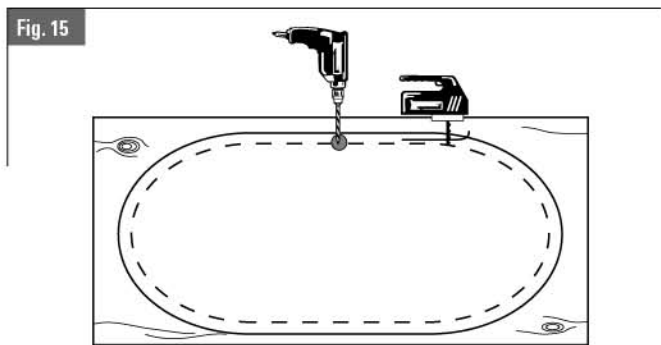

- **Step 8:** The bathtub overflow and drain should now be installed by a competent certified plumber according to the overflow manufacturers instructions, and conforming to local building codes.

- **Step 9:** Clear away and vacuum any remaining debris from inside the podium (debris could be sucked into the bathtub's systems causing damage not covered by the warranty).

- **Step 10:** Lift the bathtub and set it into the podium. Make sure that it fits properly and that there is sufficient space for the bathtub overflow plumbing. Make any necessary modifications before proceeding with the next step. If you plan to use a mortar bed mark the position of the bathtub's feet on the floor and remove the bathtub from the podium.

- **Step 11:** Mortar bed (optional). When using mortar to support a bathtub equipped with a Mass-Air or Activ-Air+ system, the mortar should be under the feet only. Under no circumstances should the mortar come into contact with the piping and fittings underneath the bathtub. In order to protect from damage, install a plastic sheet between the tub and the mortar. Freshly mixed mortar should now be placed on the floor where the bathtub's feet will land (marked out in step 10) (see fig. 16).

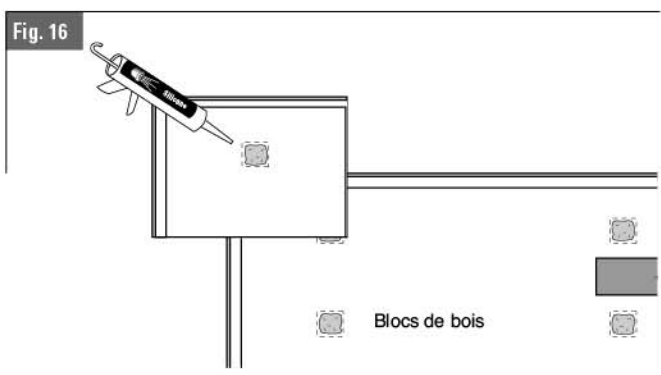

- **Step 12:** (Mortar option only) Lift the bathtub and set it into the podium. Level the bathtub lengthwise first, then across its width. Check, underneath the bathtub, that the mortar has spread and that there is adequate mortar for support under the feet. Add some if necessary.
- **Step 13:** (non-mortar option only) Level the bathtub lengthwise first, then across its width by adding adjustment shims under the feet. Glue the shims to the feet and the floor using construction adhesive. **NOTE: Do NOT use nails or screws to affix the feet to the floor.**

UNDERMOUNT BATHTUB INSTALLATION

- **Step 1:** Build a podium strong enough to support the weight of the material chosen to be put on top of it. Make sure the bathtub does not support the podium deck: there has to be a gap of about 1/16" between the bottom of the podium deck and the top of the bathtub deck.
- **Step 2:** Install the bathtub based on the instructions given in this guide.
- **Step 3:** Install the podium deck based on the instructions supplied by the manufacturer and apply a bead of silicone between the podium deck and the bathtub deck. Immediately remove any excess sealant with a clean cloth. The deck of the bathtub is designed with a slight slope, to ensure that water flows down to the inside of the bathtub. As a result, the size of the gap will vary according to how much of the bathtub deck you want to be covered by the podium deck.
- **Example A:** The podium deck is close to the outside edge. The gap between the podium deck and the bathtub deck is narrow; install the podium deck over the bathtub and apply a small bead of silicone caulk. (Figure 17A)

Figure 17A

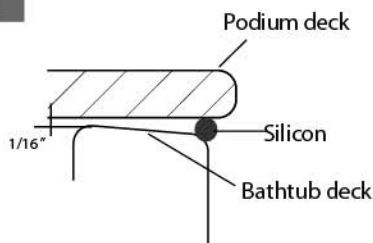

- **Example B:** The podium deck is completely covering the bathtub deck. Install the podium deck over the bathtub. In this case the gap is larger and will require a larger silicone bead, but it will not be visible since it will be entirely covered by the podium deck. (Figure 17B)

Figure 17B

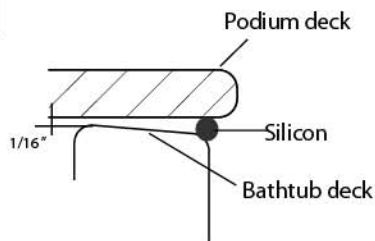

INSTALLATION OF BATHTUBS WITH CONTOUR SKIRT

When the bathtub is integrated with a contour skirt, we suggest that you follow the instructions below.

It is recommended that the installation be done by two people.

The bathtub has been leveled in factory. If an adjustment is necessary, you can use the adjustable feet by loosening the locknut on each foot, but they must be relocked in position before the final installation.

- **Step 1:** Temporarily position the entire bathtub in the desired location. If the drain is not preinstalled, mark its location on the floor so that you can reposition the bathtub correctly in the following steps (Figure 18A). Using a washable marker, draw two lines from the edge of the bathtub to the skirt (Figure 18B) to establish a reference point for Step 7.

An opening of 15cm x 30cm (6" x 12") needs to be cut into the floor for the bathtub drain and overflow (see fig. 18a). Make sure that there are no obstructions in this space.

Figure 18A

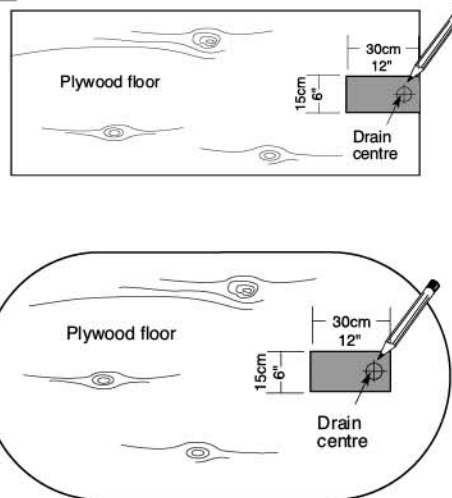
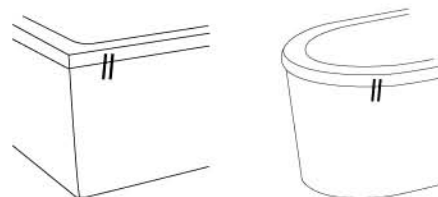

Figure 18B



- **Step 2:** Remove only the bathtub, being careful to not move the skirt. Next, draw the interior outline of the skirt on the floor with a lead pencil to determine skirt location. (Figure 19)
- **Step 3:** Remove the skirt and reposition only the bathtub according to the previously drawn lines, placing the feet through the wooden blocks provided. (Figure 20)
- **Step 4:** Place the wooden blocks parallel to the skirt and use the lead pencil to mark the location of the wooden blocks on the floor. (Figure 20)
- **Step 5:** Remove the bathtub again. Glue and/or screw the wooden blocks to the floor in the previously determined locations. (Figure 21)
- **Step 6:** Apply a thin line of silicone under the skirt and put it into place.
- **Step 7:** Position the bathtub, being careful to fully integrate the bathtub feet into the wooden blocks and the skirt inside the bathtub edge. Make sure that the two reference lines drawn in Figure 18B are well aligned.

Important: The bathtub must rest on its feet and on the skirt. The feet must be in contact with the floor and the skirt in contact with the bathtub edge at all times.

- **Step 8:** Leave the bathtub in this position for at least 24 hours.

Figure 19

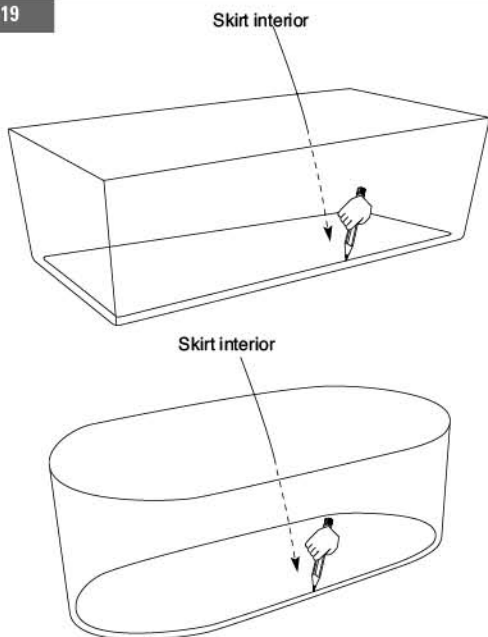

Figure 20

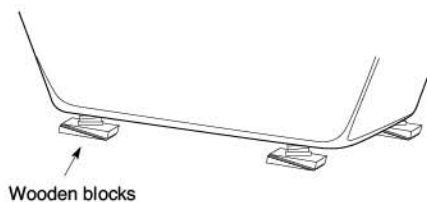
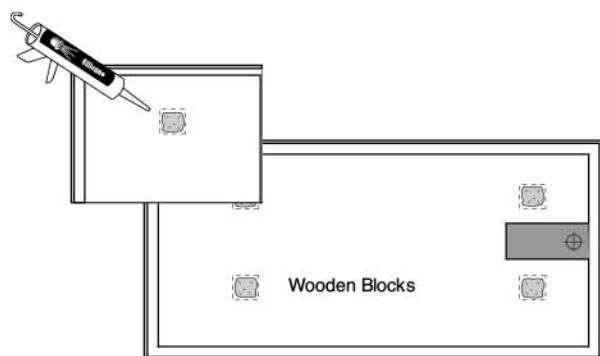

Figure 21



Notes: A) For bathtubs with a contour skirt and wood base, the wooden blocks are factory installed and adjusted. Accordingly, affix the wood base to the floor in the desired location, checking the drain position, and then proceed with Step 6.

B) We recommend the two following methods for future service access:

1) Cut an access panel in the floor under the bathtub if circumstances allow.

2) Remove the bathtub from the skirt if required for maintenance.

C) The structure of this style of bathtub is not designed to sit on the edge, the acrylic skirt may crack and the tub itself.

D) A tape with foam can be install between the skirt and the tub to avoid squeaking noise.

FAUCET INSTALLATION

- **Step 1:** (Bathtub mounted faucets) Faucets can be mounted either onto the podium, or they can be attached directly to the bathtub. When attachment to the bathtub is called for, great care must be taken when drilling through the acrylic.
 - Align the faucet knob handles and ensure they are leveled before drilling the holes.
 - Always use a sharp hole-saw with a pilot bit that extends at least 1/4" below it.
 - The hole saw must always be larger than the fitting, forcing an object through a hole that is too small will damage the acrylic.
 - Drill slowly and steadily letting the tool do the work. This will help to reduce heat build-up and binding at the acrylic surface.
 - When installing the fixtures never over-tighten them as this can cause damage to the acrylic surface.
- **Step 2:** Now that the plumbing installation is complete, your new bathtub needs to be leak tested. We recommend a 20 minute soak test, the bathtub should be filled above the level of the overflow and left to stand for 20 minutes. If no leaking is detected at the bathtub or the plumbing hook-ups during or after 20 minutes you may continue with the installation.

ULTIM-O AND KARA DRAIN ASSEMBLY

- **Step 1:** The drain kit comes assembled in a bag.
- **Step 2:** Remove the threaded stainless steel strainer from the black ABS elbow. Unscrew in a counterclockwise direction.
- **Step 3:** Install the black ABS elbow under the bathtub rim and apply a generous amount of silicone.
- **Step 4:** Reinsert the strainer into the ABS elbow leading to the bathtub interior. Tighten by screwing in a clockwise direction.
- **Step 5:** The automatic push button should already be installed in the strainer. If it is not, the bottom of the push button will be threaded. Insert the end piece into the small hole on the bottom of the strainer and screw in a clockwise direction to tighten.
- Cut the piping according to the bathtub model and your installation.

BATHTUB TYPE	PIPING				
	A	B	C	D	E
TAO-RUBY foot location					
32 X 60	3 1/2"	14 1/2"	4 1/2"	8 1/2"	8 1/2"
TAO-RUBY centered					
36 X 66	3"	15 3/4"	7 3/4"		
36 X 72	3"	17 1/8"	10 1/4"		
42 X 72	2 5/8"	18 5/8"	7 3/4"		
KARA					
44 X 77	5"	12"	15 3/4"		
MACAO					
60 X 60	24 3/4"	15 3/4"			

NOTE: Our ABS pipes are black.

If the RUBY bathtub comes with an air system, you might have to groove the opening at the base of the skirt to clear the drain.

ULTIM-O AND KARA DRAIN ASSEMBLY

TAO-RUBY foot location



TAO-RUBY centered

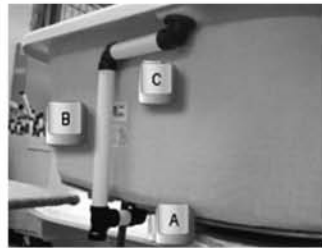

KARA



MACAO



WISH BATHTUB AND DRAIN INSTALLATION

It is strongly recommended to have two people for this installation. It is necessary to have access under the bathtub to complete the installation. If it is not possible, please follow steps 1-6 and then refer to steps A to G.

- **Step 1:** Place bathtub on its side on a protected surface or place on blocks before installing the drain;
- **Step 2:** Put a bead of silicone around the drain cup of the bath;
- **Step 3:** Insert the strainer (# 4) and the putty ring (# 5a) inside the drain of the bathtub ensuring alignment between the hole of the strainer with the hole of the overflow channel;
- **Step 4:** Put a bead of silicone in the waste washer (# 5b) and then insert in the strainer under the bathtub;
- **Step 5:** Gently screw the waste assembly nut (# 6) under the strainer and tighten until the waste washer and the strainer are secured tightly, while ensuring that it keeps its initial alignment;
- **Step 6:** Immediately wipe the excess silicone;
- **Step 7:** Gently screw tailpiece nut (# 7c) with the brass tailpiece (# 7a) and the washer (# 7b) in the strainer and tighten;
- **Step 8:** Put the bath in place ensuring the insertion of the brass tailpiece into the PVC pipe outlet (not provided);
- **Step 9:** Tighten the coupling ring of the PVC pipe (not provided);
- **Step 10:** Place a bead of silicone on the periphery of the bathtub on the ground;
- **Step 11.** Do not use the bathtub for 24 hours.

Figure 22

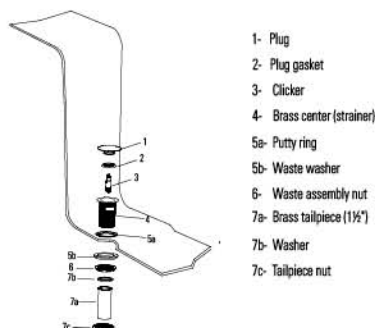

WISH BATHTUB AND DRAIN INSTALLATION

(CONTINUED)

- **Step A:** Make sure the PVC pipe drain in the floor is placed at the right height and perfectly fixed;
- **Step B:** Place the brass tailpiece (# 7a) inside the seal ring and tighten it to maintain watertightness while still being able to remove and replace the brass tailpiece inside without loosening the ring;
- **Step C:** Remove the brass tailpiece from the PVC pipe then tighten with the tailpiece nut (# 7c) in the strainer, maintaining the seal (# 7b) between the two;
- **Step D:** Place a bead of silicone on the inside top of the sealing ring of the PVC pipe outlet;
- **Step E:** Put the bathtub in place ensuring the insertion of the brass tailpiece into the PVC pipe outlet;
- **Step F:** Place a bead of silicone on the periphery of the bathtub on the ground;
- **Step G:** Do not use the bathtub for 24h.

SYSTEM HOOK-UP (electrical installation)

All electrical connections should be done by a competent licensed electrician and in accordance with the local building codes in your area. An access panel is mandatory. Most building codes require that there is an access panel of at least 30 cm x 50 cm (12" x 22") in order to service the plumbing, motor, control unit and keypad. In case of a breakdown, the access panel must allow the technician to access the defective components. Produits Neptune shall not be liable for any additional costs caused by the absence of an access panel.

All components exceeding 6 AMP (pump, blower, water-heater or ozonator) must be connected to an independent 15 AMP ground fault circuit interrupter (GFCI) breaker. Where allowed by law, they can be hooked up to GFCI outlets connected to a regular breaker.

The bathtub systems and controls are designed to operate on 110/120 Volt AC 60 Hz (North America).

- **Step 1:** Turn off the power to the bathtub circuit at the electrical panel.
- **Step 2:** Hook up the wiring from the control module and/or pump and/or inline heater and/or light to the circuit panel using the appropriate cable gauge (see fig. 16 and 17). If the distance from the electrical panel to the bathtub is further than 30 m (100 ft), refer to your local building code to make sure that a sufficient gauge cable is used.
- **Step 3: Electronic touch pad or switch:** The hole for the electronic touch pad or switch is drilled at the factory. The pad or switch has a self-sealing gasket that will hold it in place. Depending on your model, it will plug directly into the motor or control module. (See the figure that represents your configuration)
- **Step 4:** Now that the electrical installation is complete, the power can be turned on at the electrical panel. The bathtub should be filled above the level of the jets, and the systems should be tested. (See page 31 for the operating instructions).

Fig. 23 Whirlpool

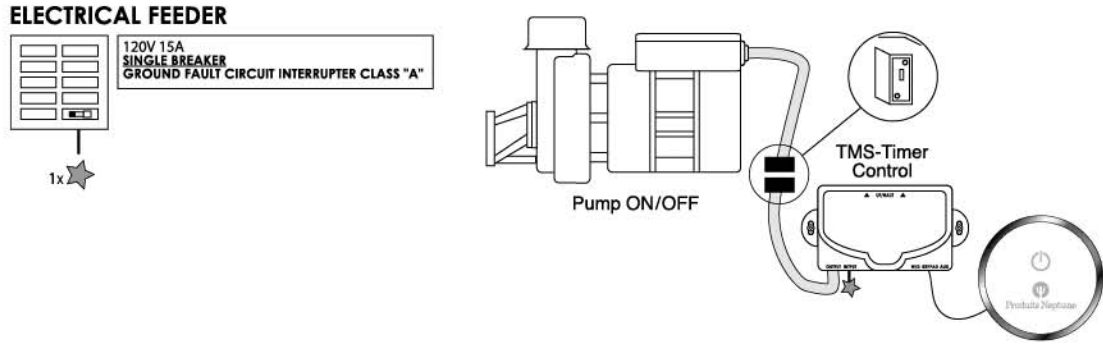

Fig. 24 Mass-Air

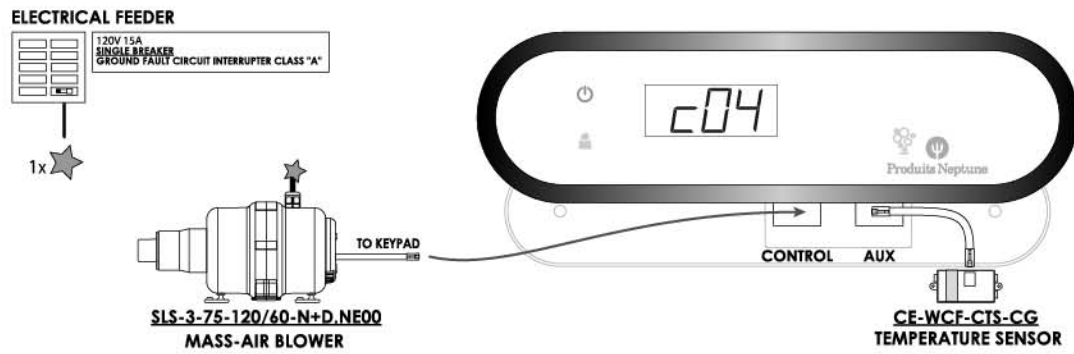

Fig. 25 Activ-Air

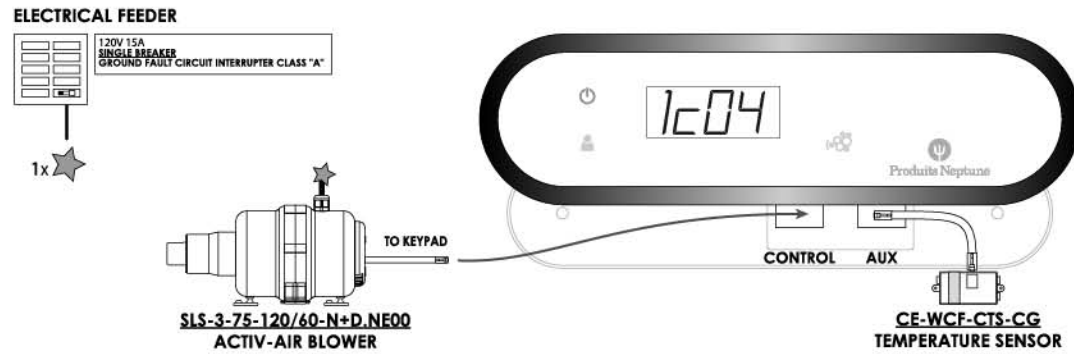

Fig. 26 Mass-Air + Light

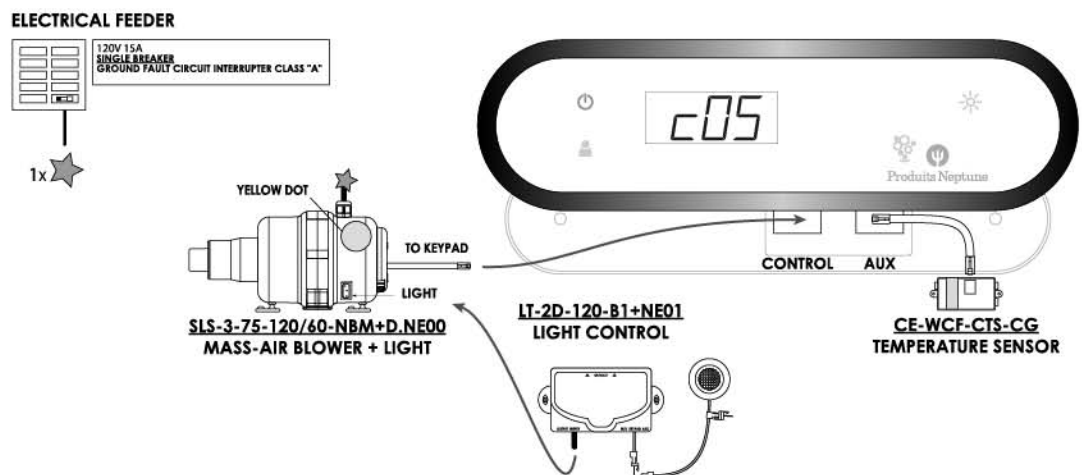

Fig. 27 Activ-Air + Light

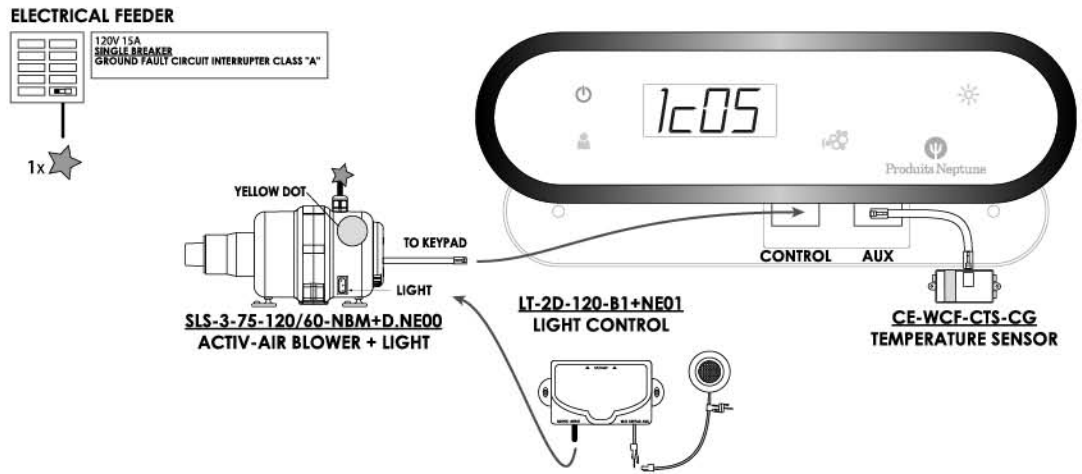

Fig. 28 Mass-Air + Whirlpool

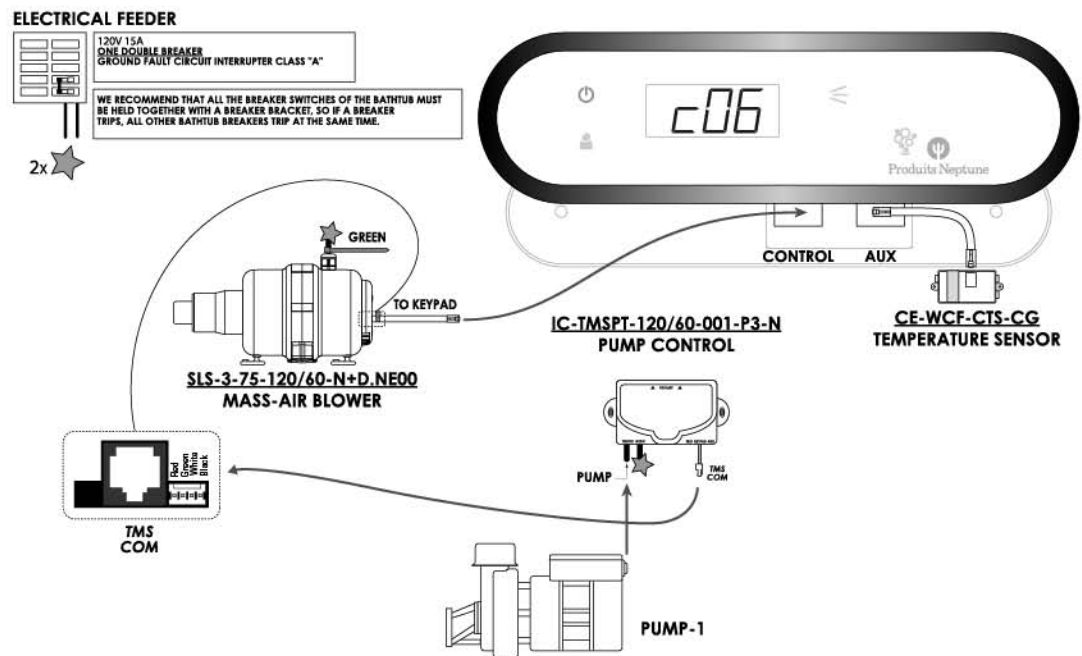

Fig. 29 Activ-Air + Whirlpool

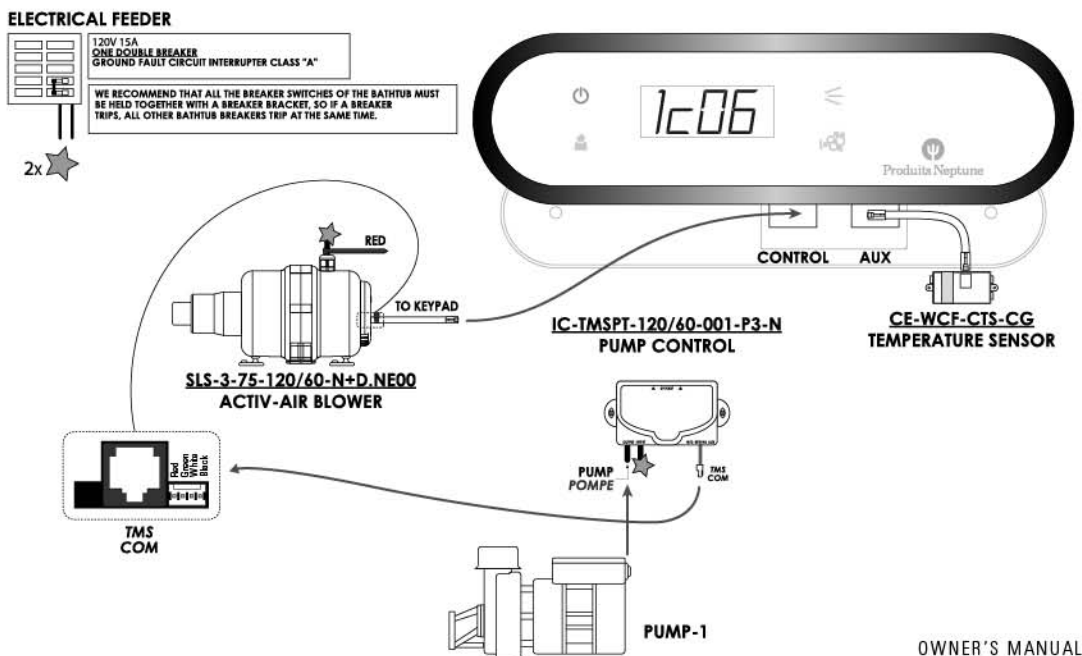

Fig. 30 Mass-Air
+ Whirlpool
+ Light

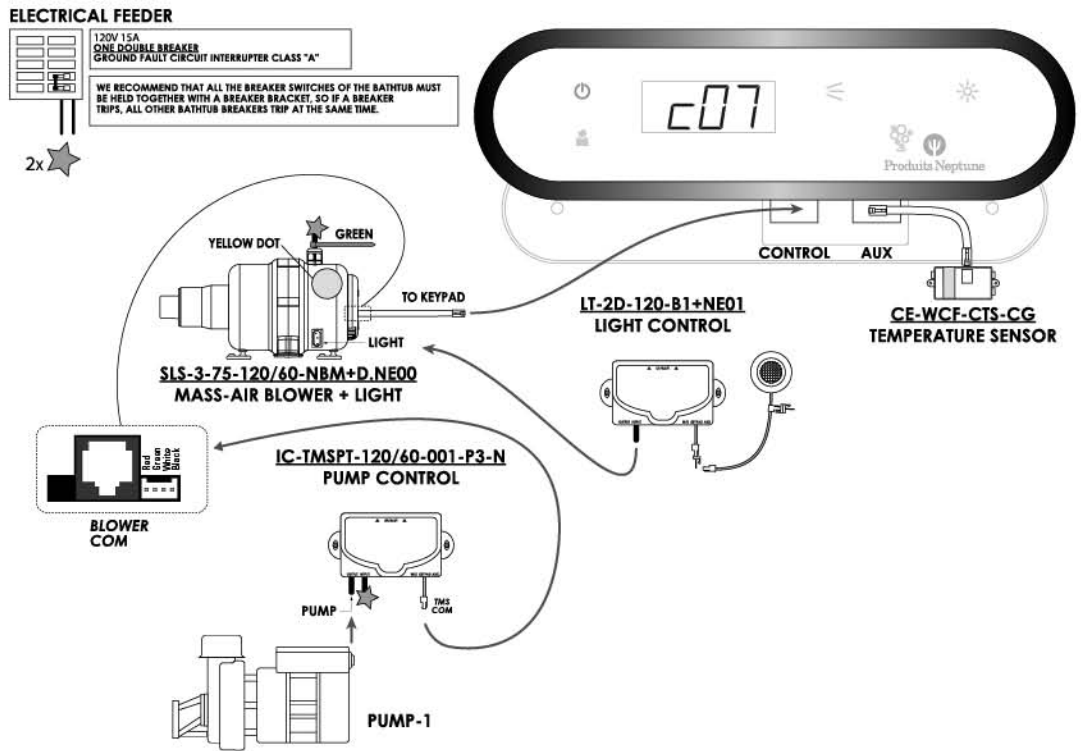

Fig. 31 Activ-Air
+ Whirlpool
+ Light

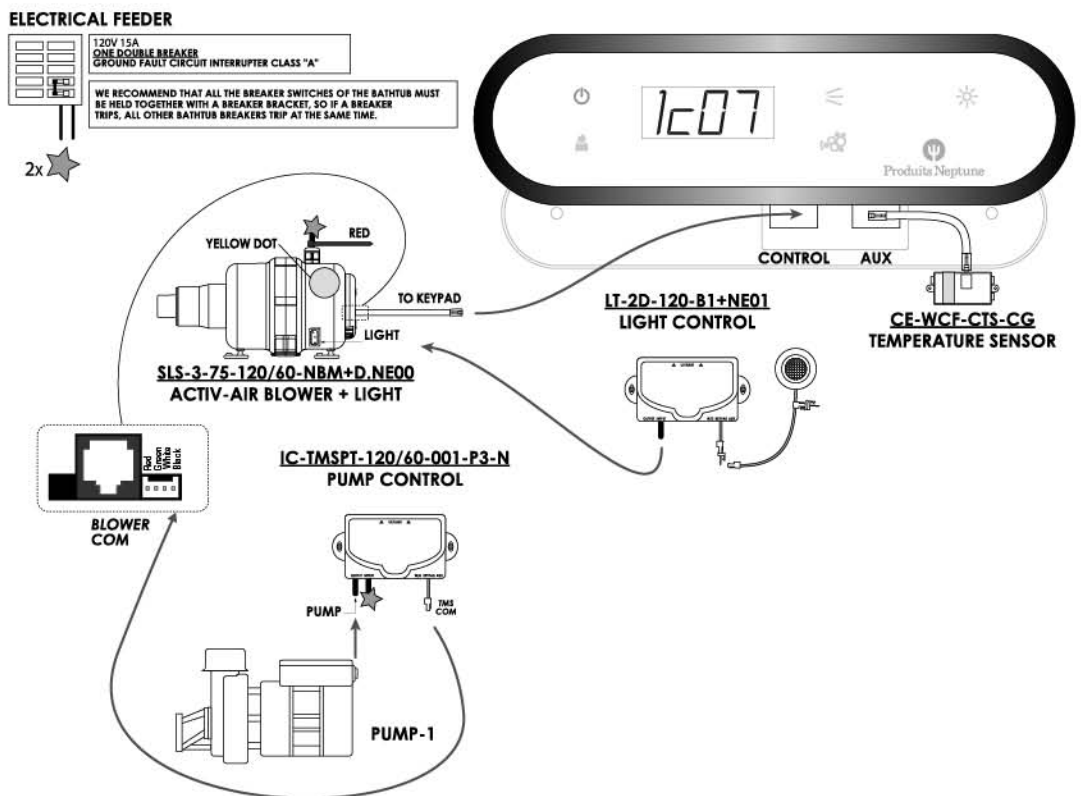

Fig. 32 Mass-Air + Activ-Air

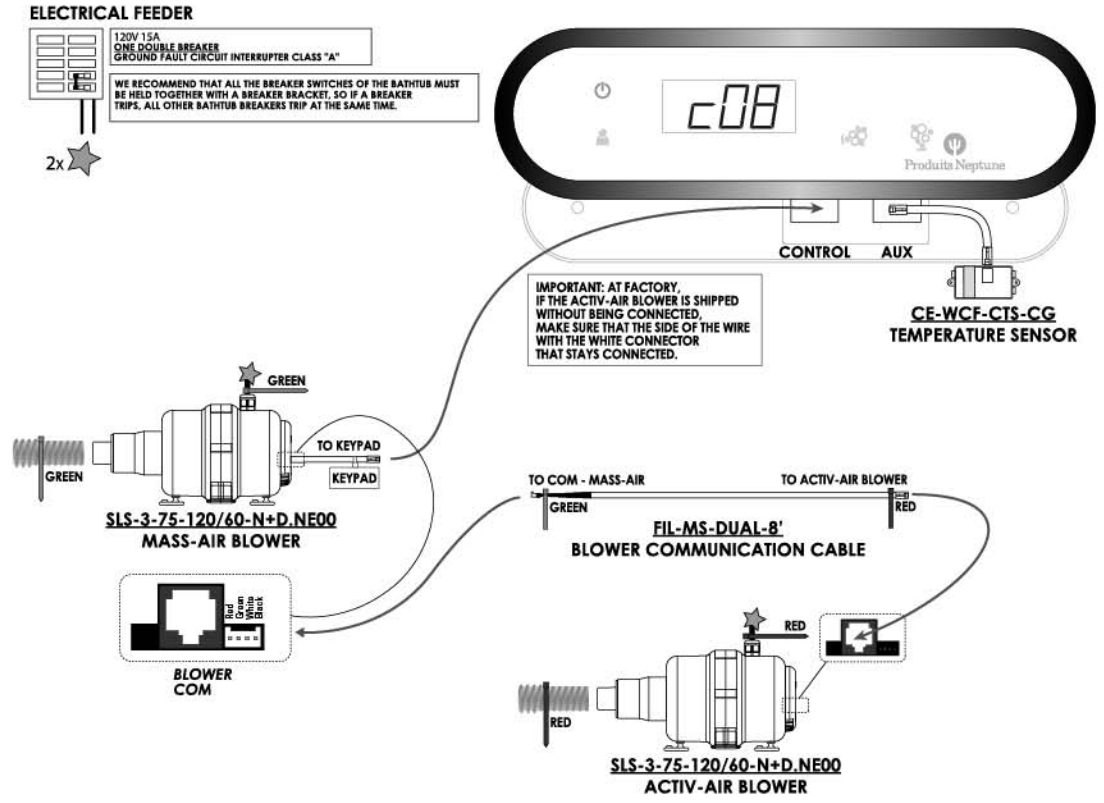

Fig. 33 Mass-Air + Activ-Air + Light

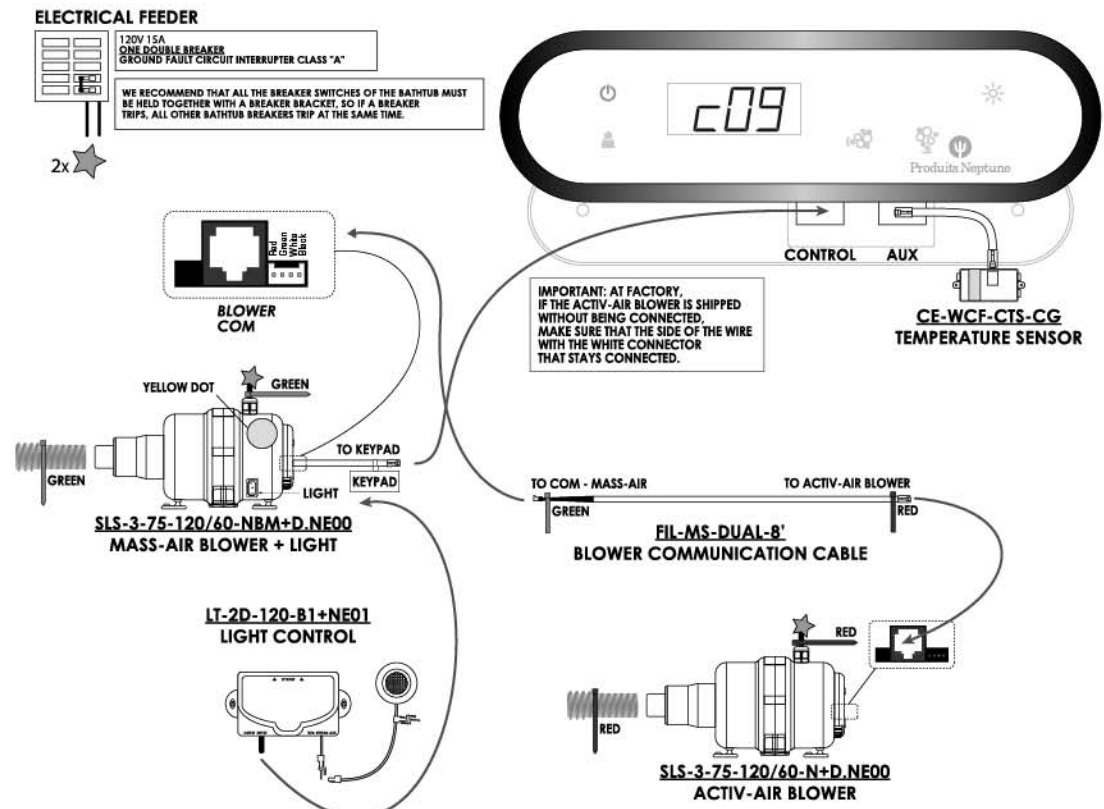

Fig. 34 2-Whirlpool

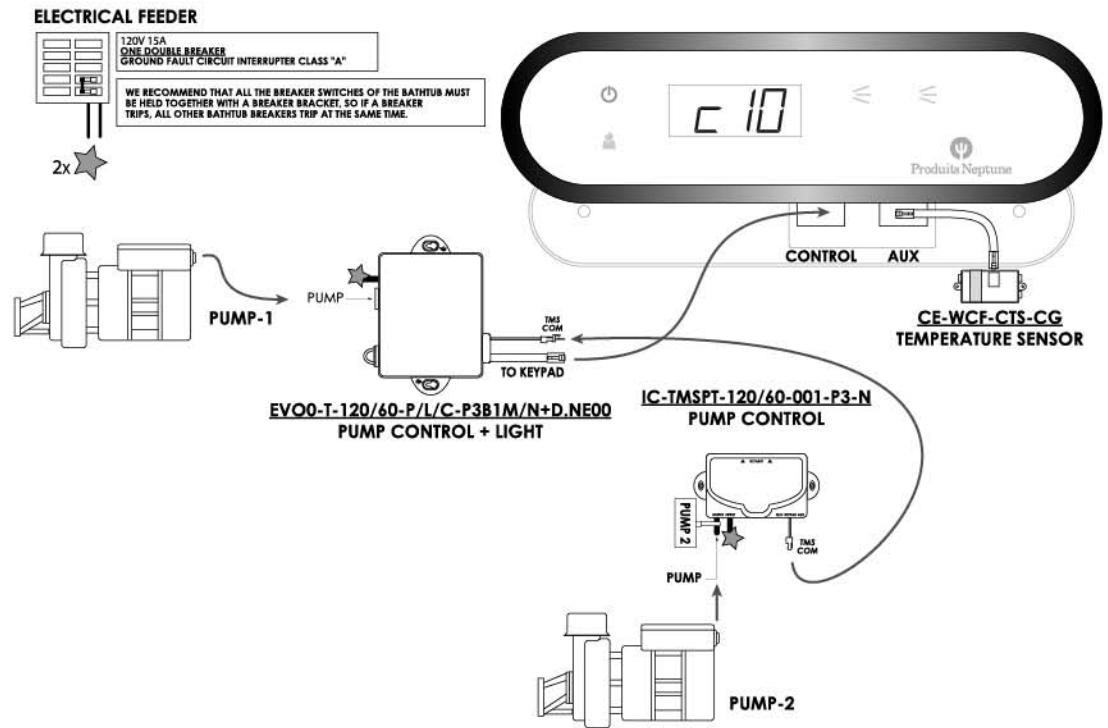

Fig. 35 2-Whirlpool + Light

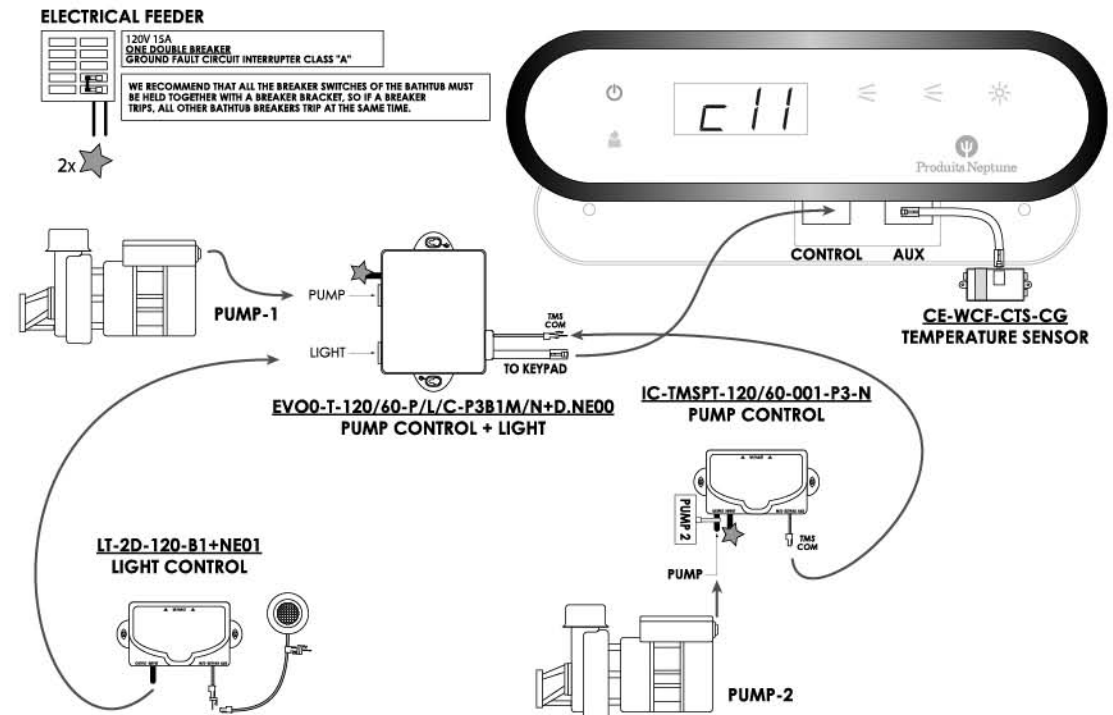

Fig. 36 Mass-Air + 2-Whirlpool

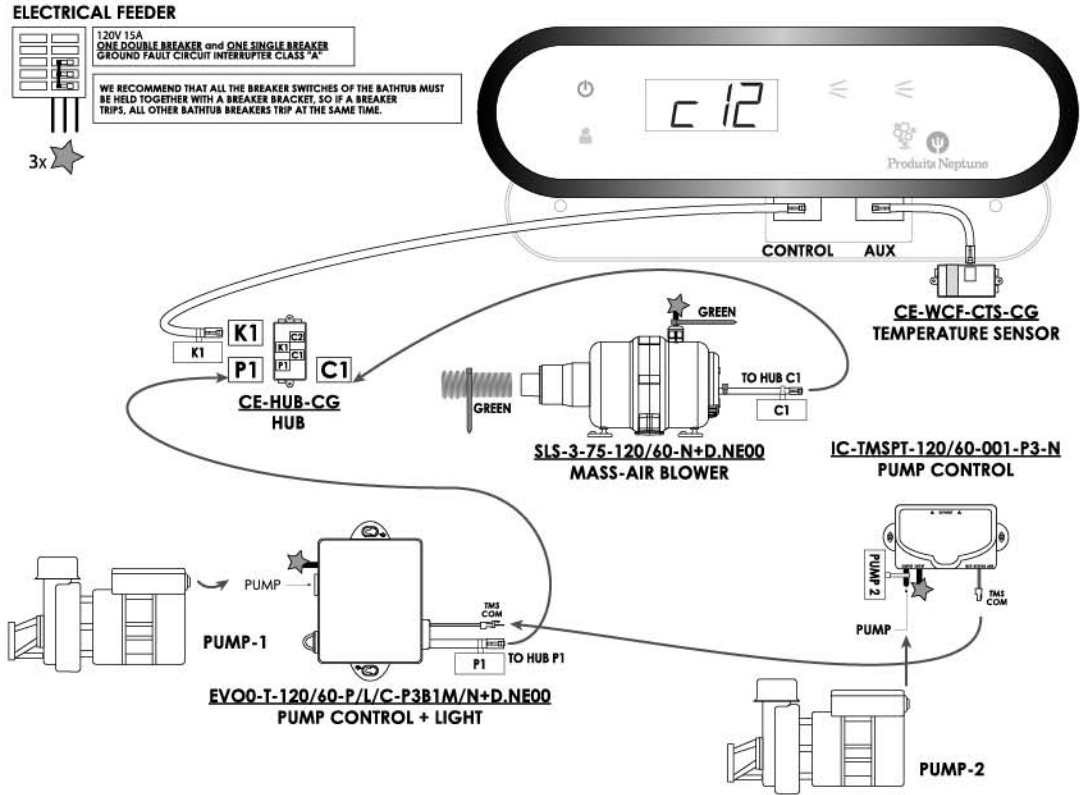

Fig. 37 Activ-Air + 2-Whirlpool

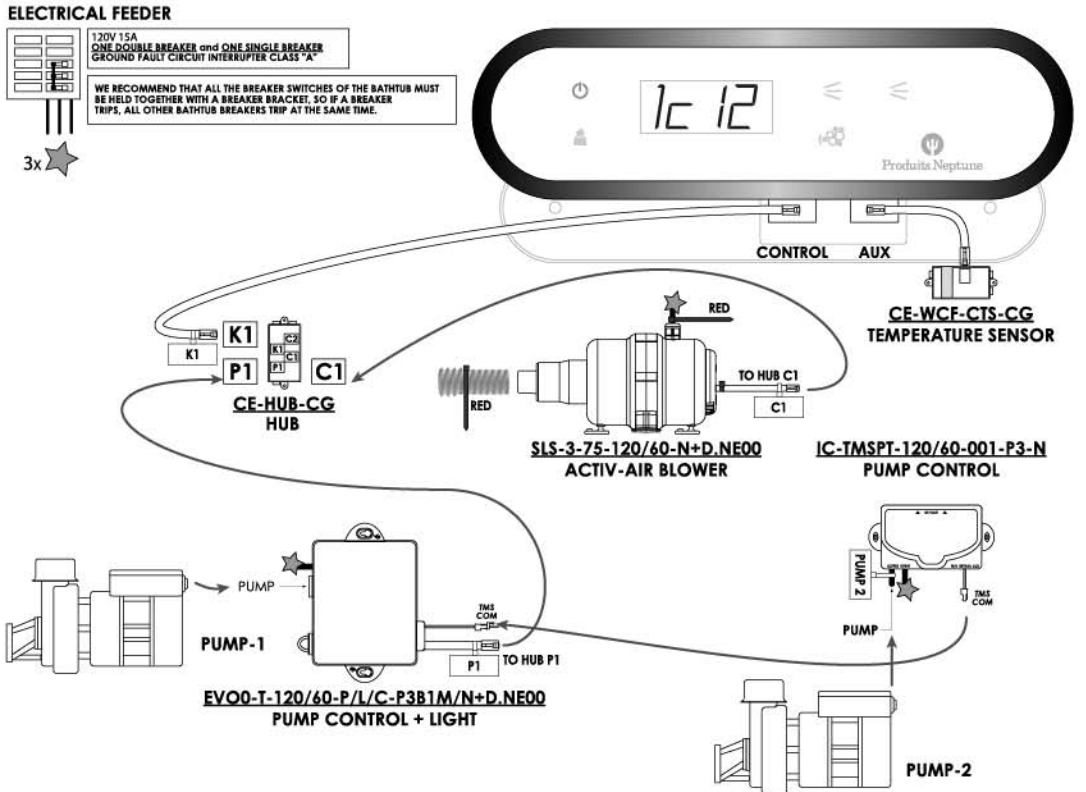

Fig. 38 Mass-Air
+ 2-Whirlpool
+ Light

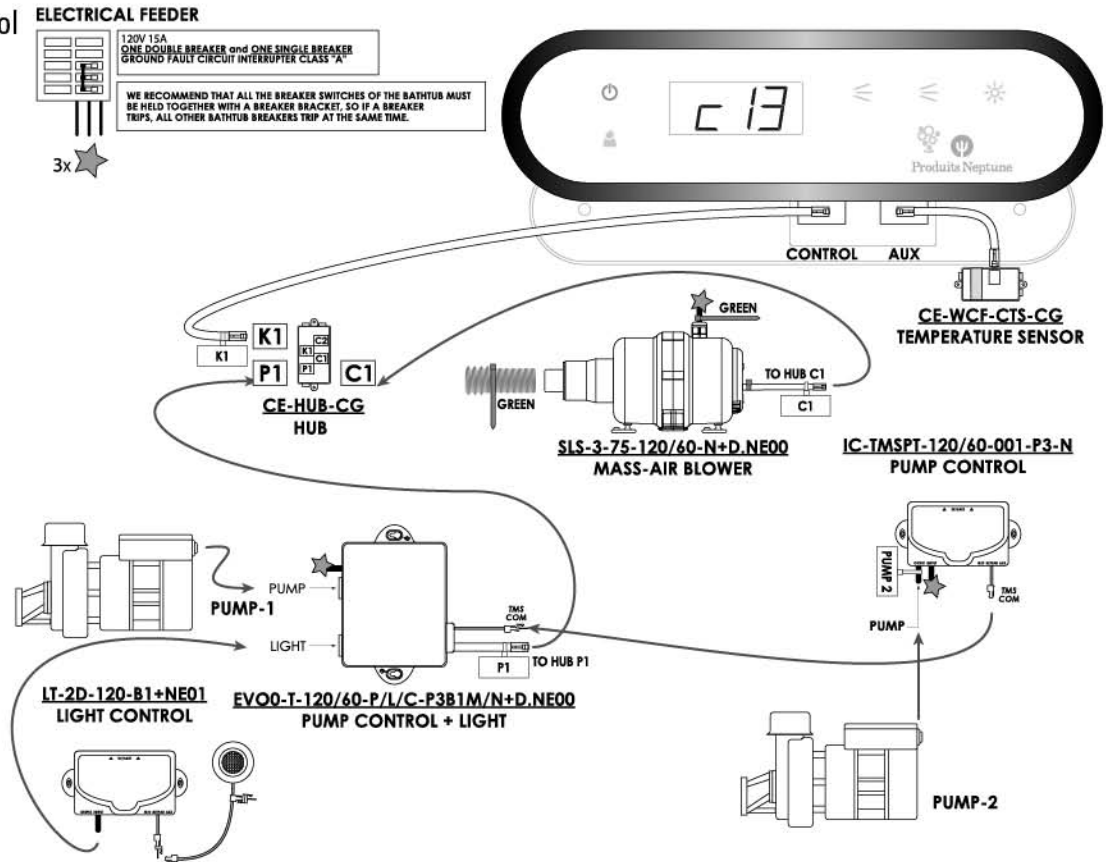

Fig. 39 Activ-Air
+ 2-Whirlpool
+ Light

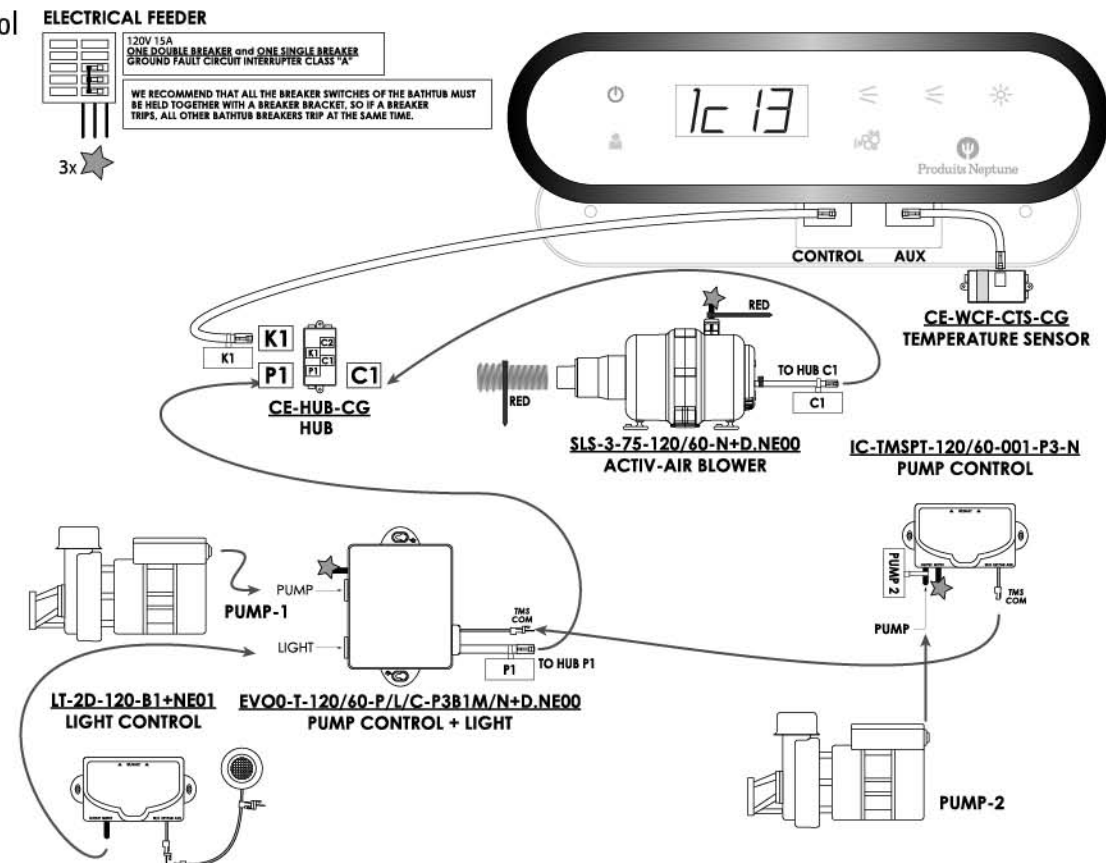

Fig. 40 Mass-Air
+ Activ-Air
+ Whirlpool

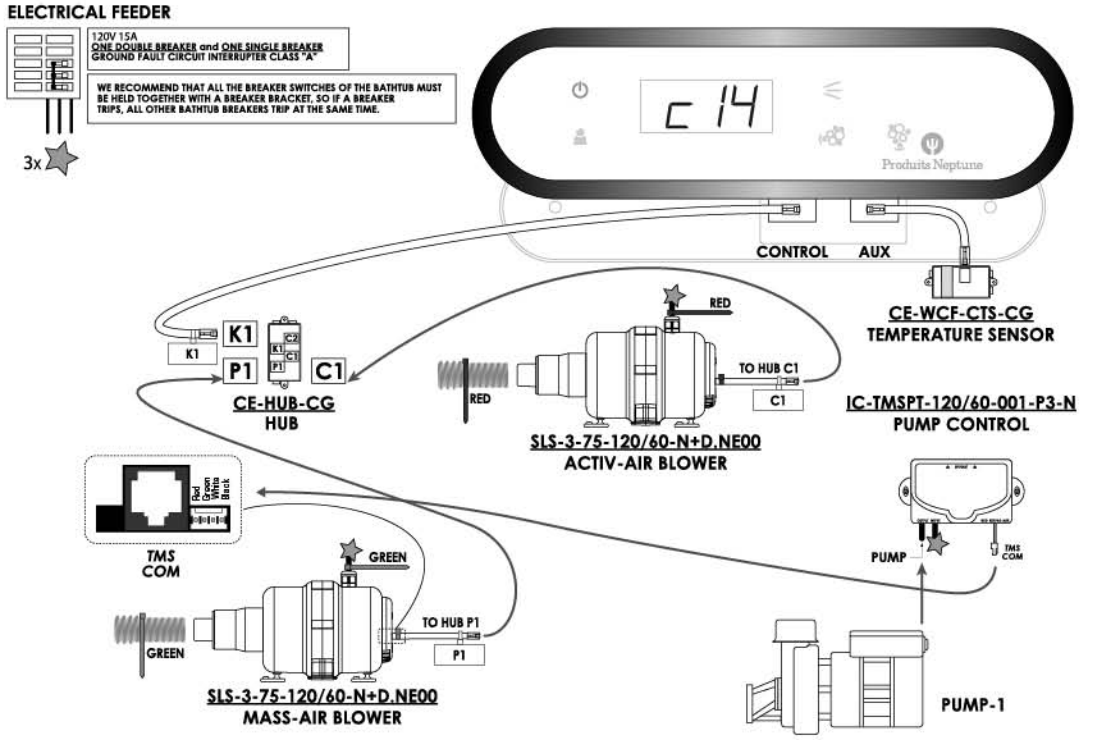

Fig. 41 Mass-Air
+ Activ-Air
+ Whirlpool
+ Light

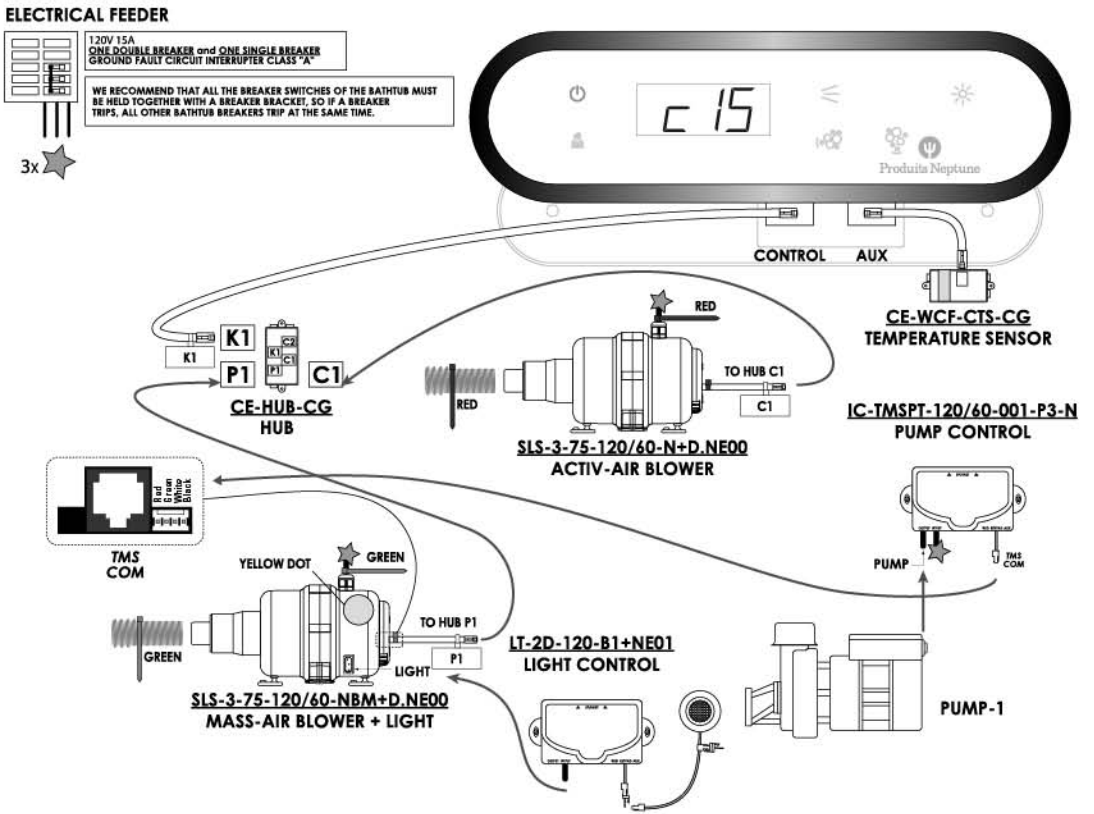

Fig. 42 Mass-Air
+ Activ-Air
+ 2-Whirlpool

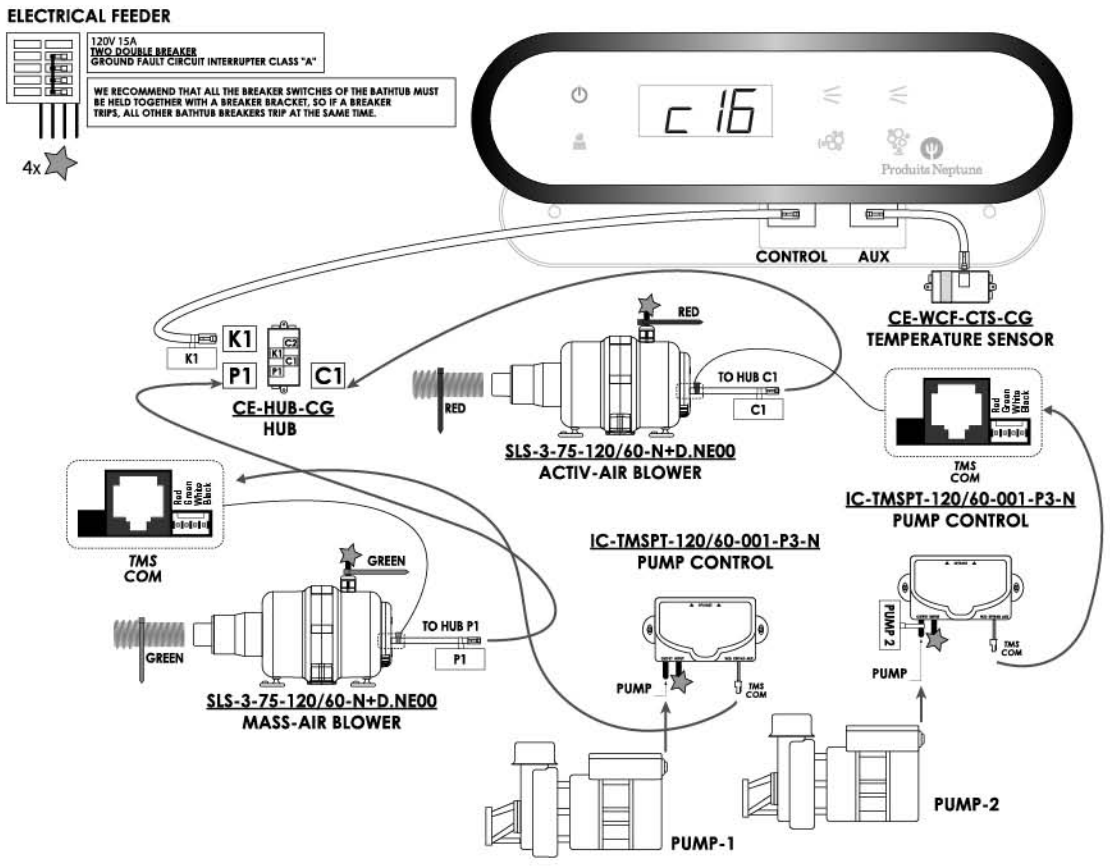

Fig. 43 Mass-Air
+ Activ-Air
+ 2-Whirlpool
+ Light

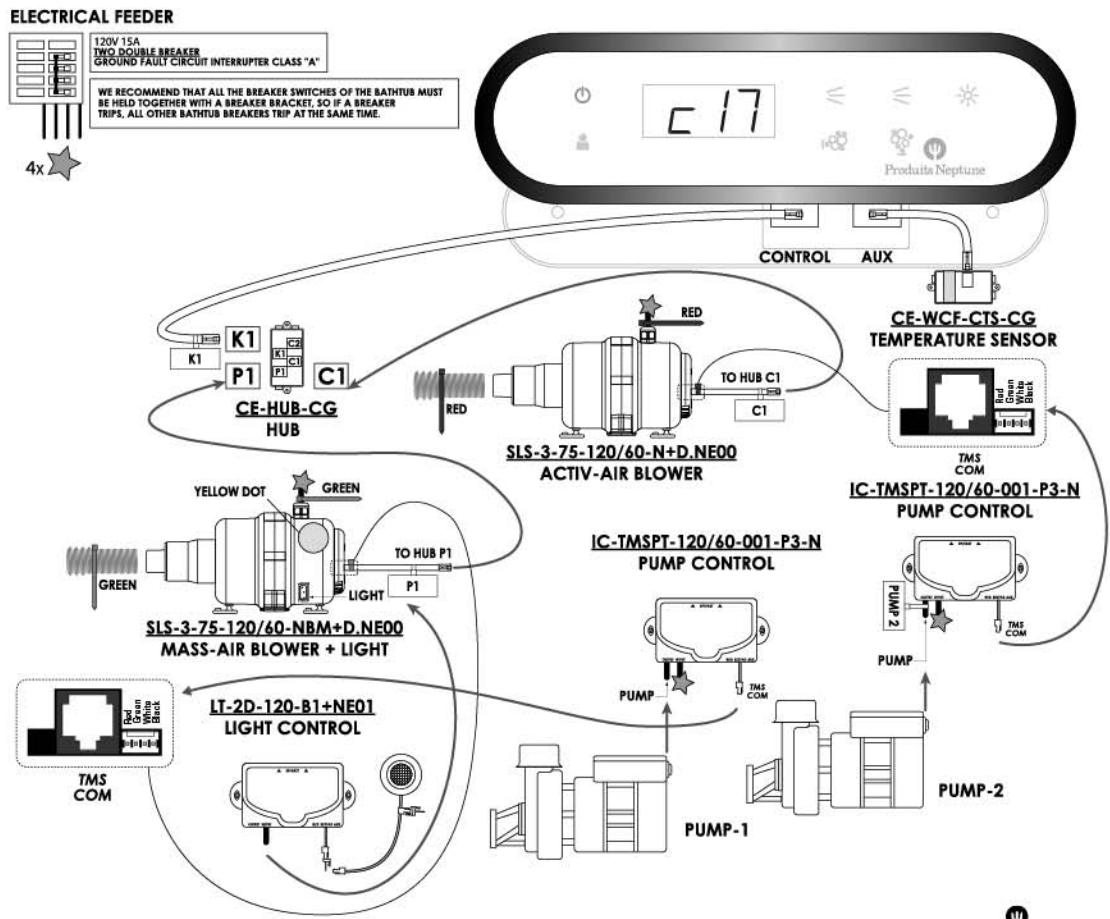

Fig. 44 Whirlpool + Turbo-Air

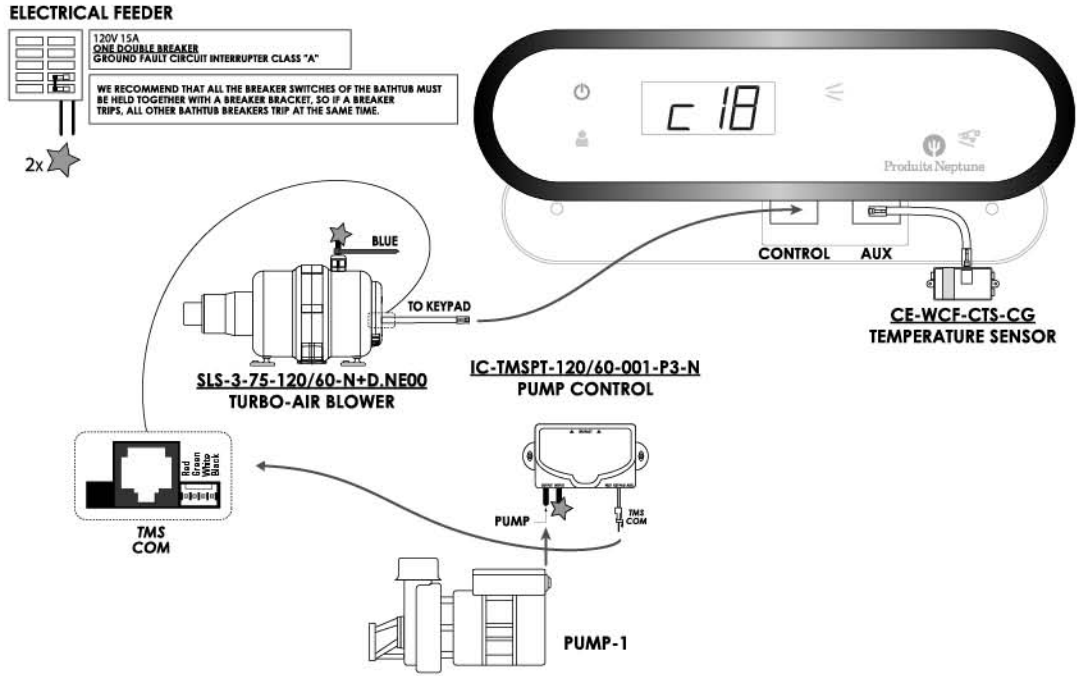

Fig. 45 Whirlpool + Turbo-Air + Light

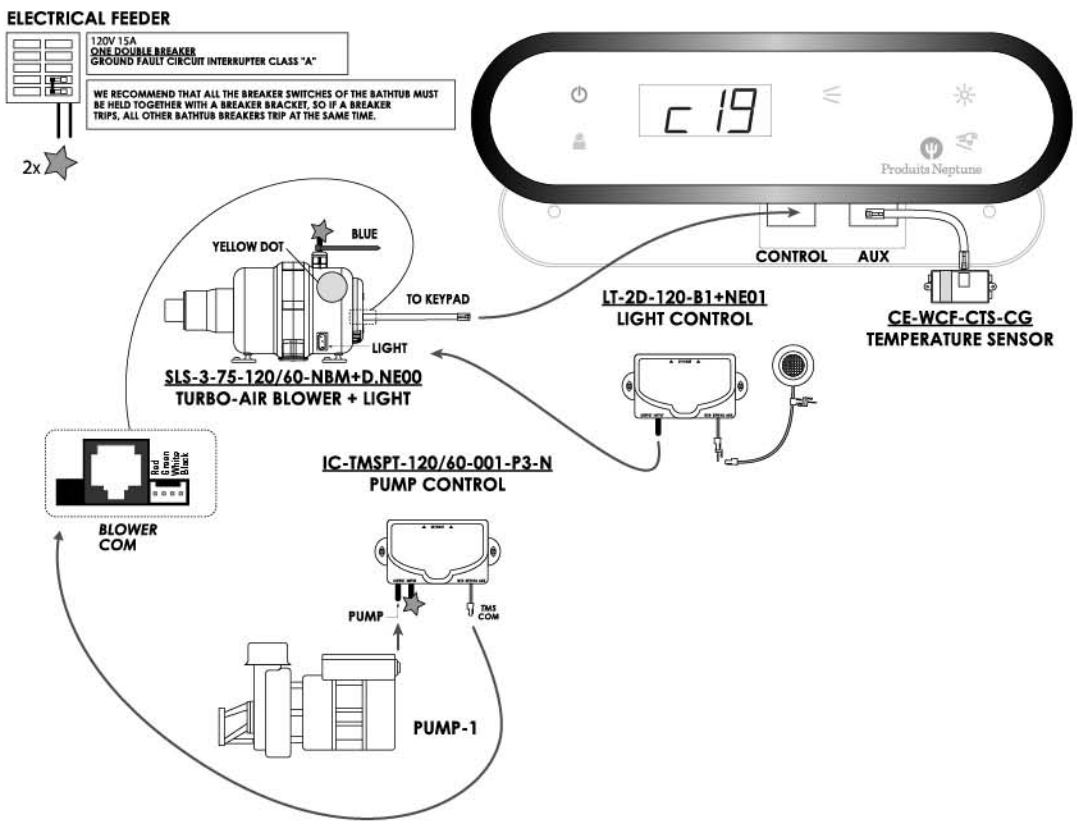

Fig. 46 Mass-Air
+ Whirlpool
+ Turbo-Air

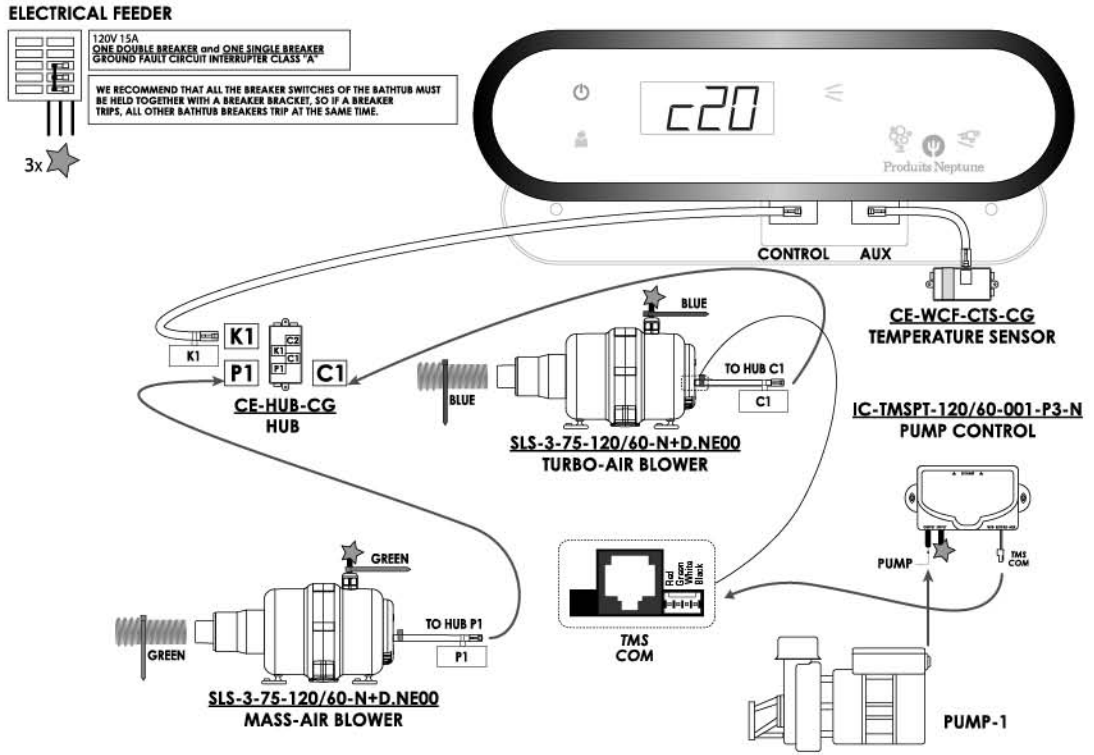

Fig. 47 Activ-Air
+ Whirlpool
+ Turbo-Air

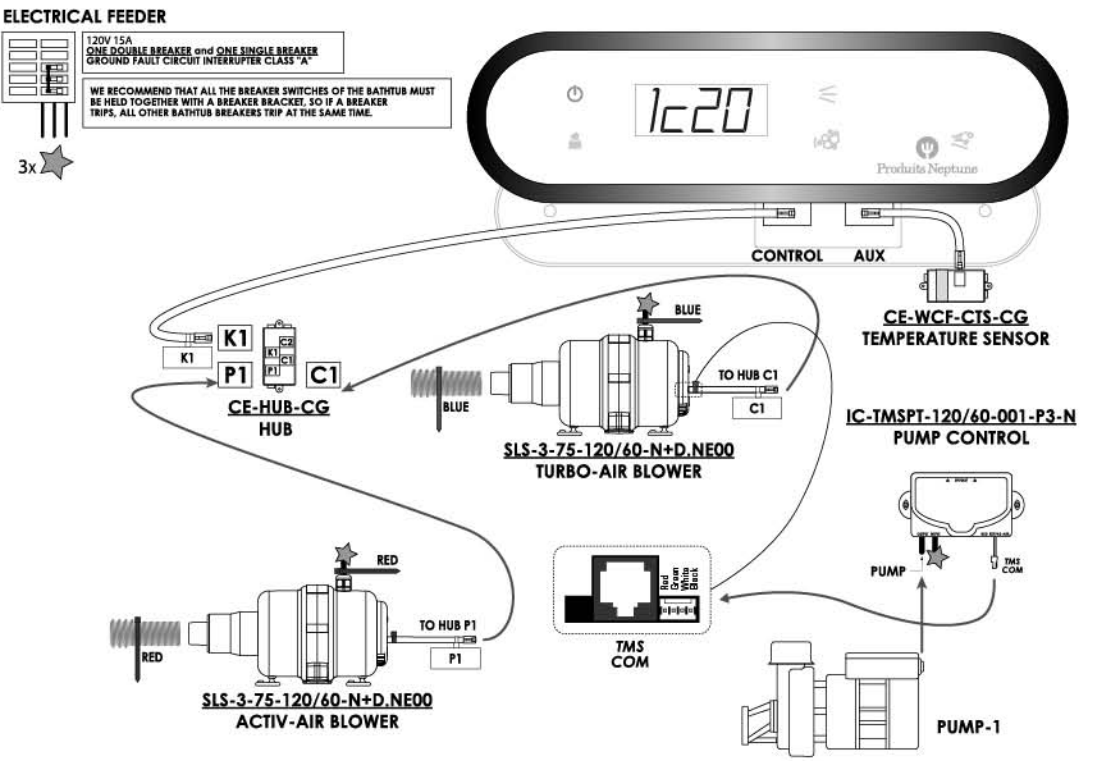

Fig. 48 Mass-Air
+ Whirlpool
+ Turbo-Air
+ Light

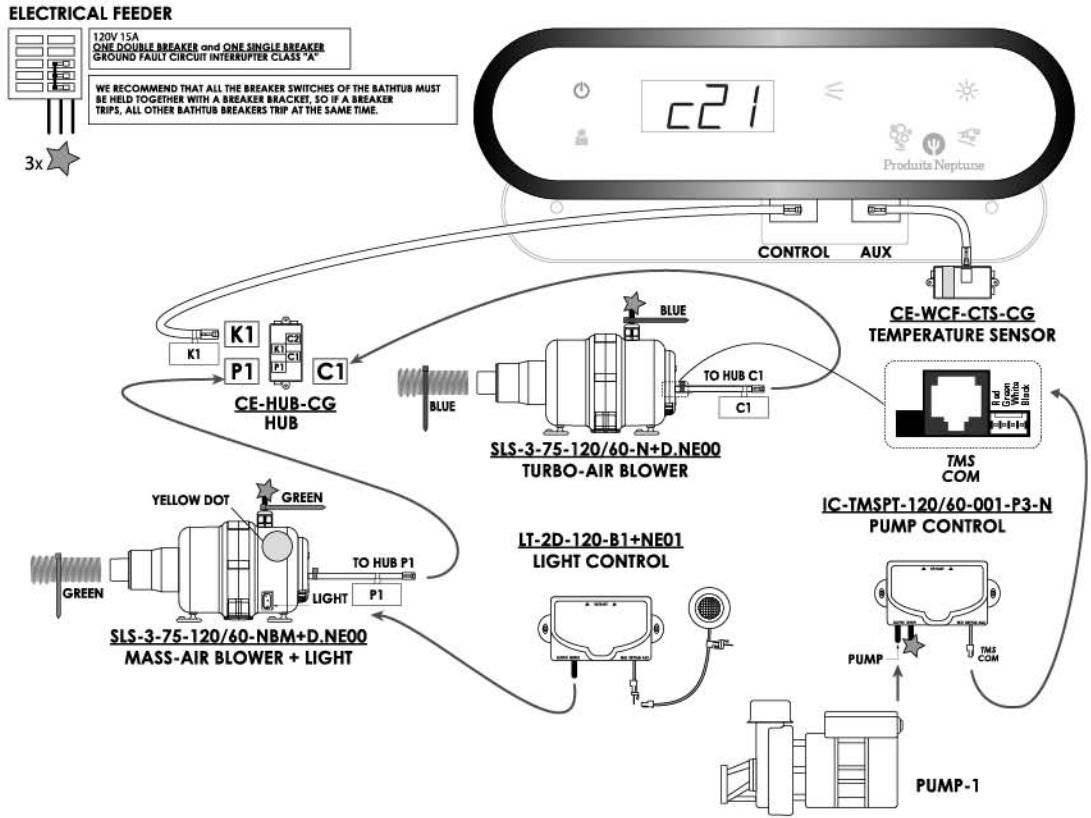

Fig. 49 Activ-Air
+ Whirlpool
+ Turbo-Air
+ Light

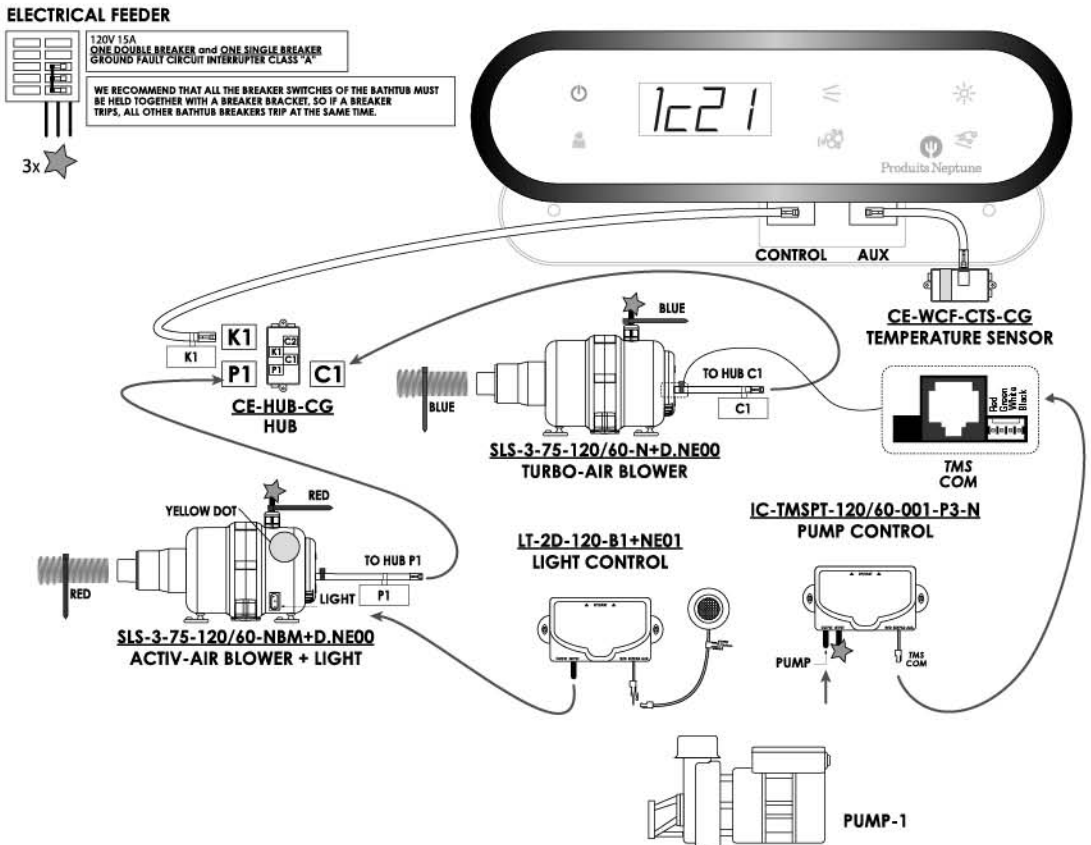

Fig. 50 Mass-Air
+ Activ-Air
+ Whirlpool
+ Turbo-Air

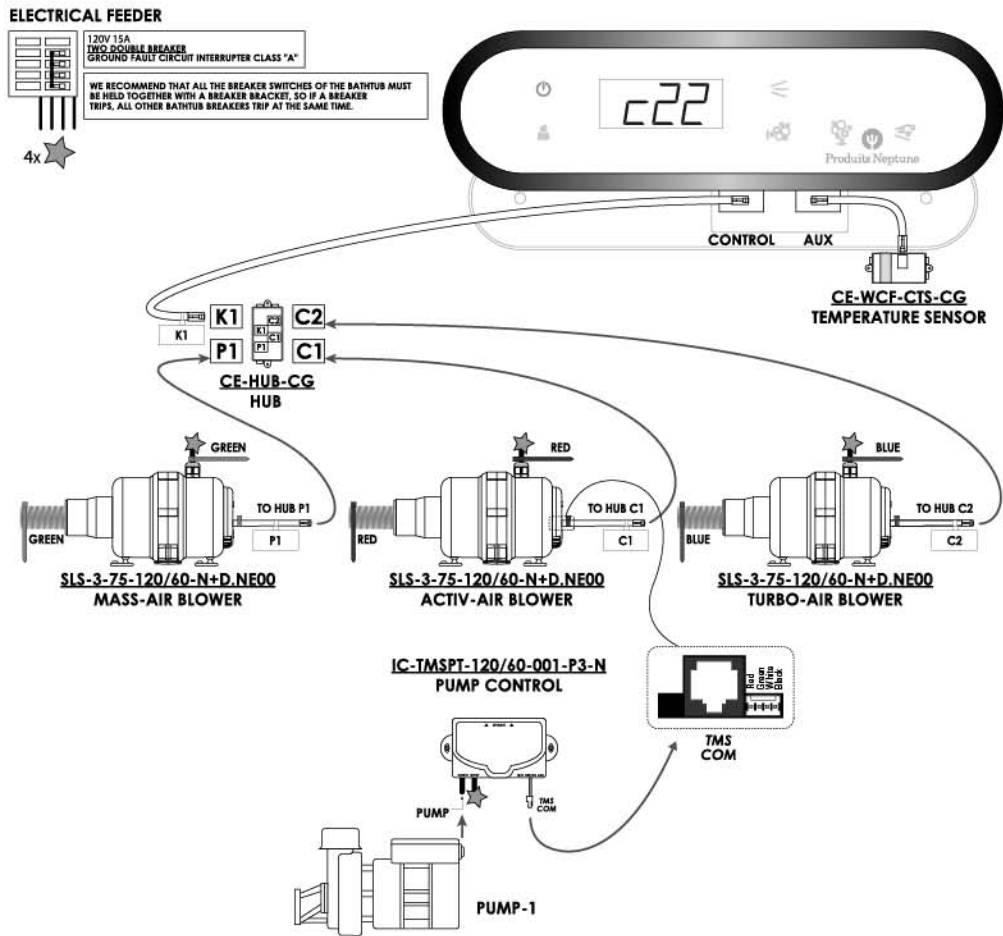

Fig. 51 Mass-Air
+ Activ-Air
+ Whirlpool
+ Turbo-Air
+ Light

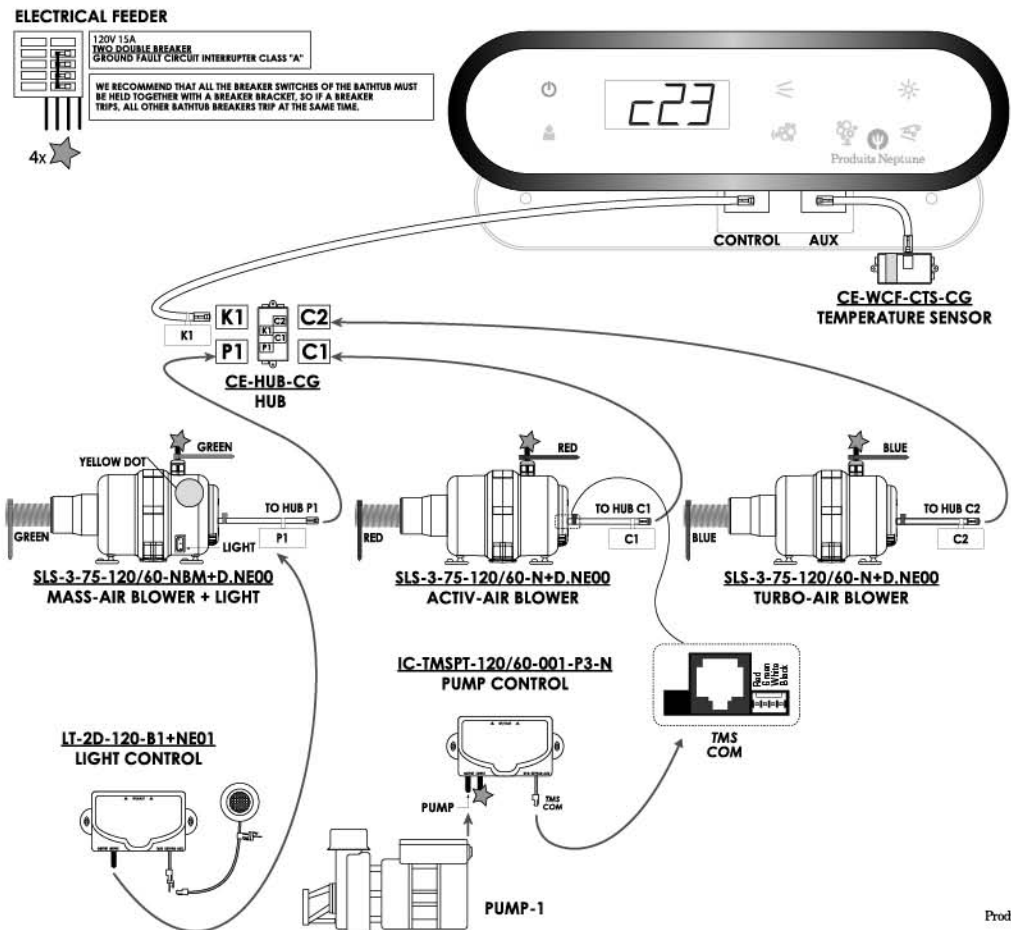

Fig. 52

Mass-Air
+ Activ-Air
+ 2-Whirlpool
+ Turbo-Air

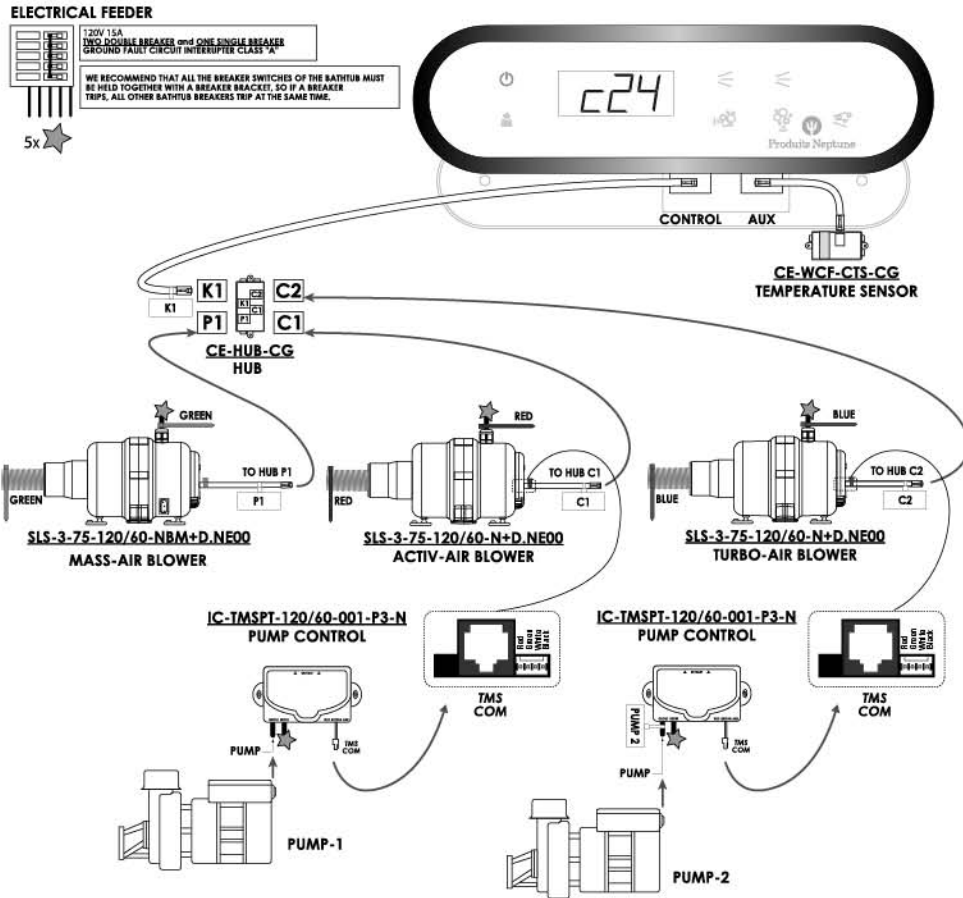

Fig. 53

Mass-Air
+ Activ-Air
+ 2-Whirlpool
+ Turbo-Air
+ Light

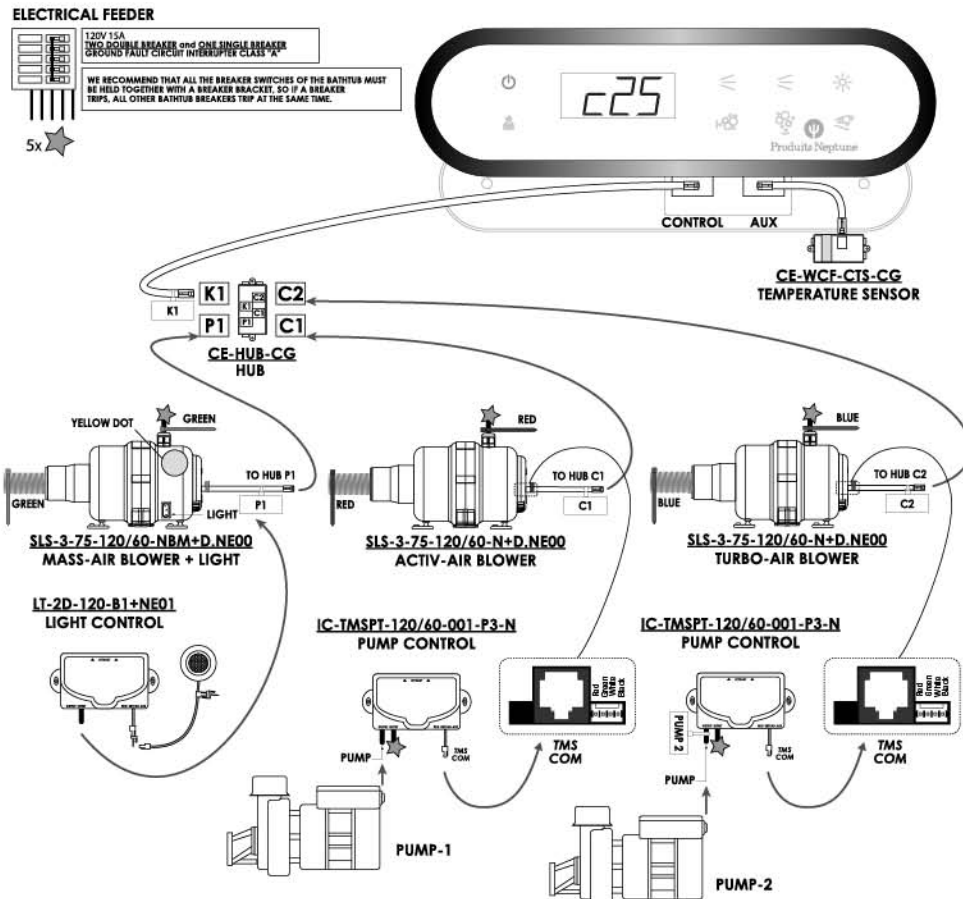

Fig. 54 2-Whirlpool + Turbo-Air

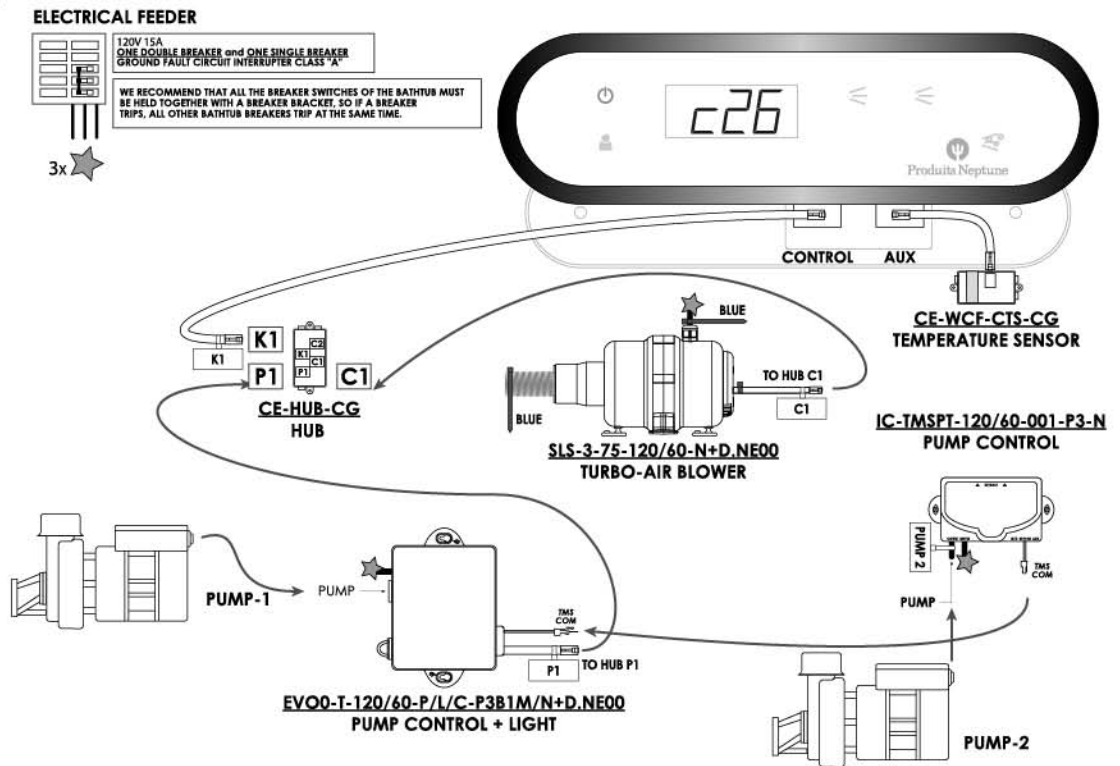

Fig. 55 2-Whirlpool + Turbo-Air + Light

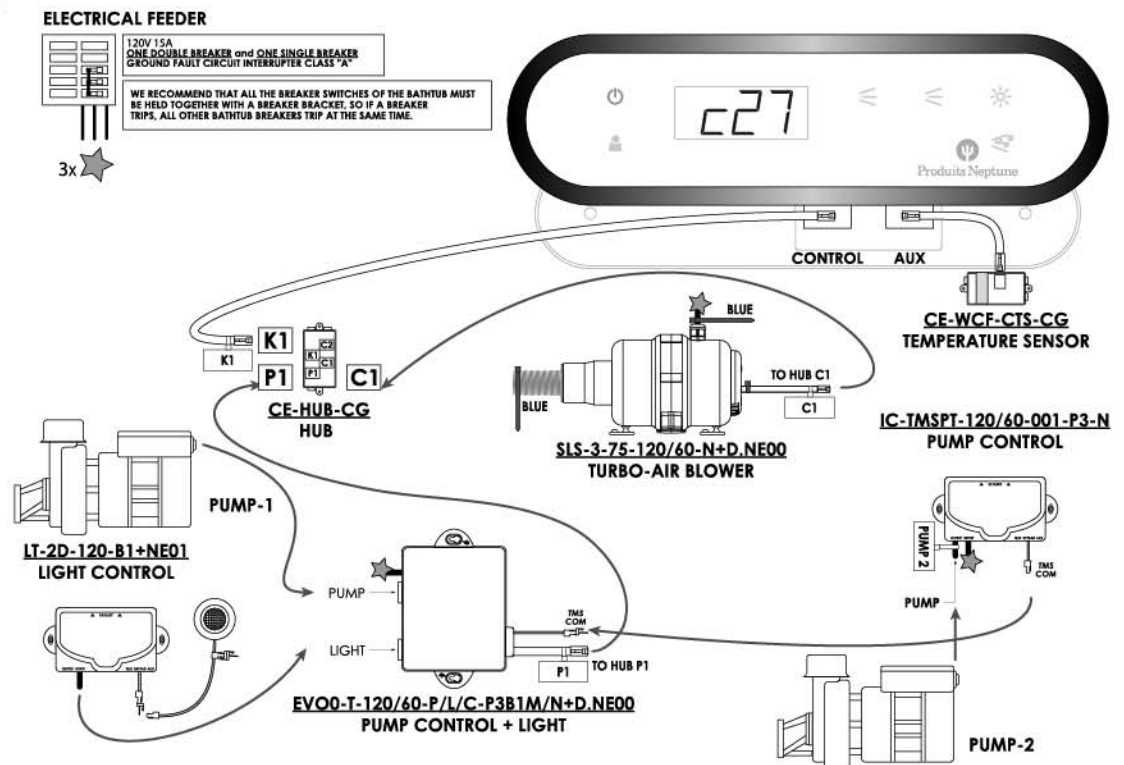

Fig. 56 Mass-Air
+ 2-Whirlpool
+ Turbo-Air

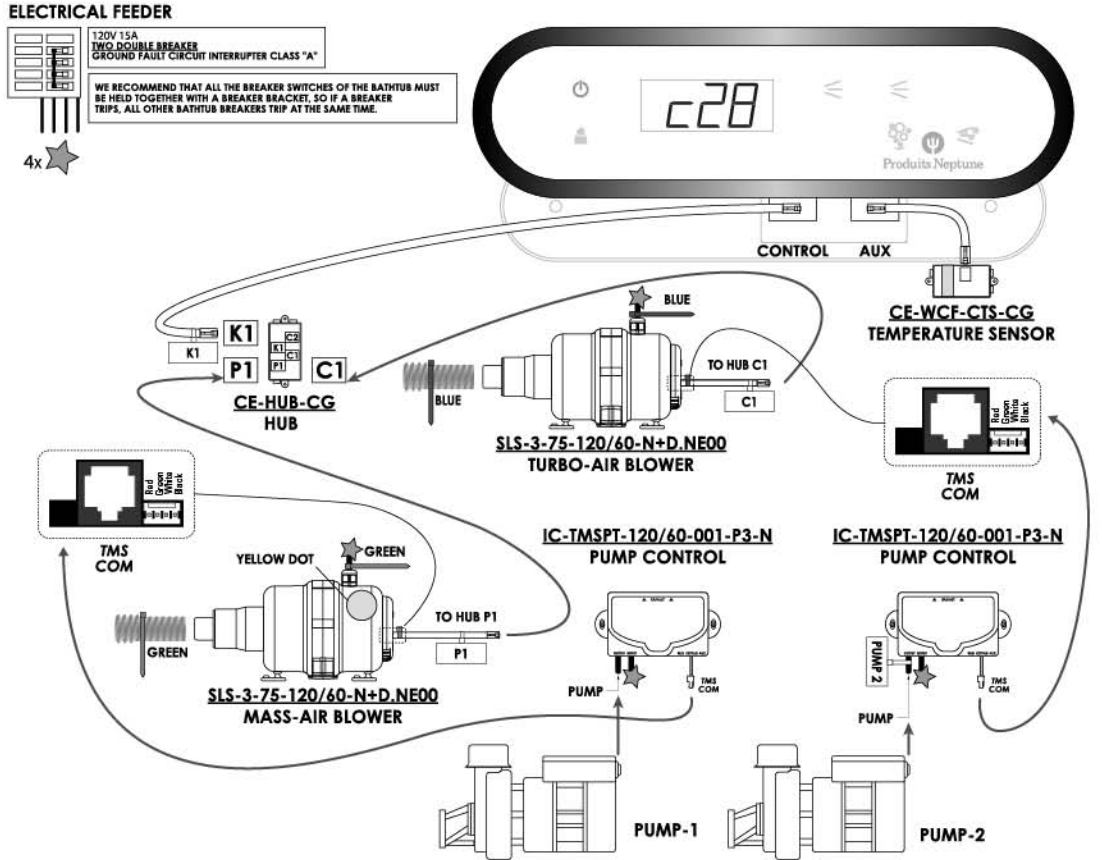

Fig. 57 Activ-Air
+ 2-Whirlpool
+ Turbo-Air

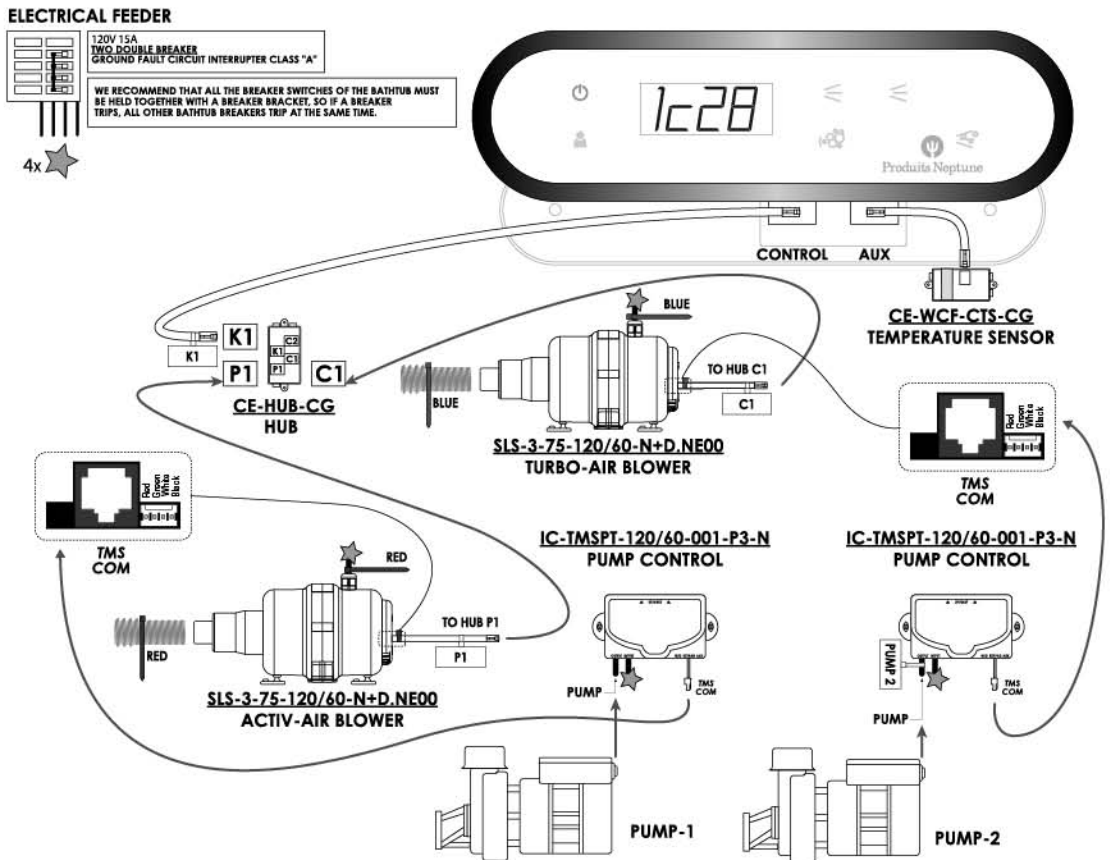

Fig. 58 Mass-Air
+ 2-Whirlpool
+ Turbo-Air
+ Light

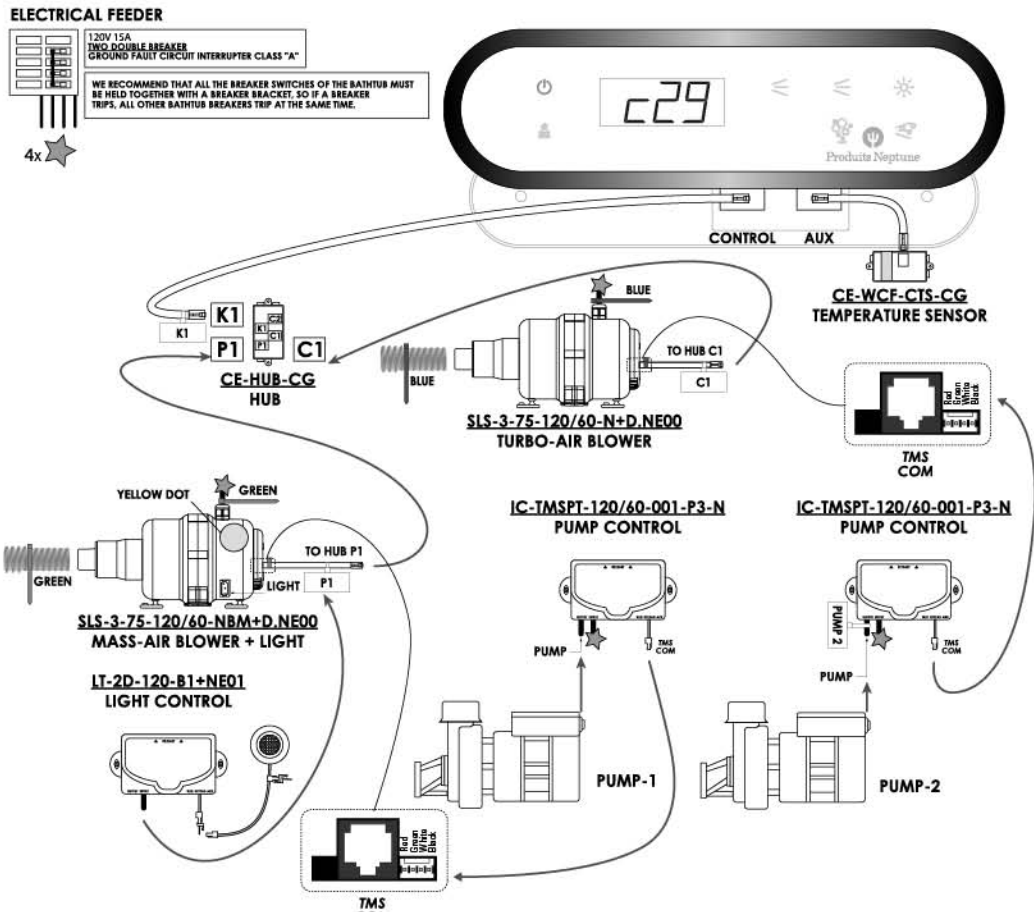

Fig. 59 Activ-Air
+ 2-Whirlpool
+ Turbo-Air
+ Light

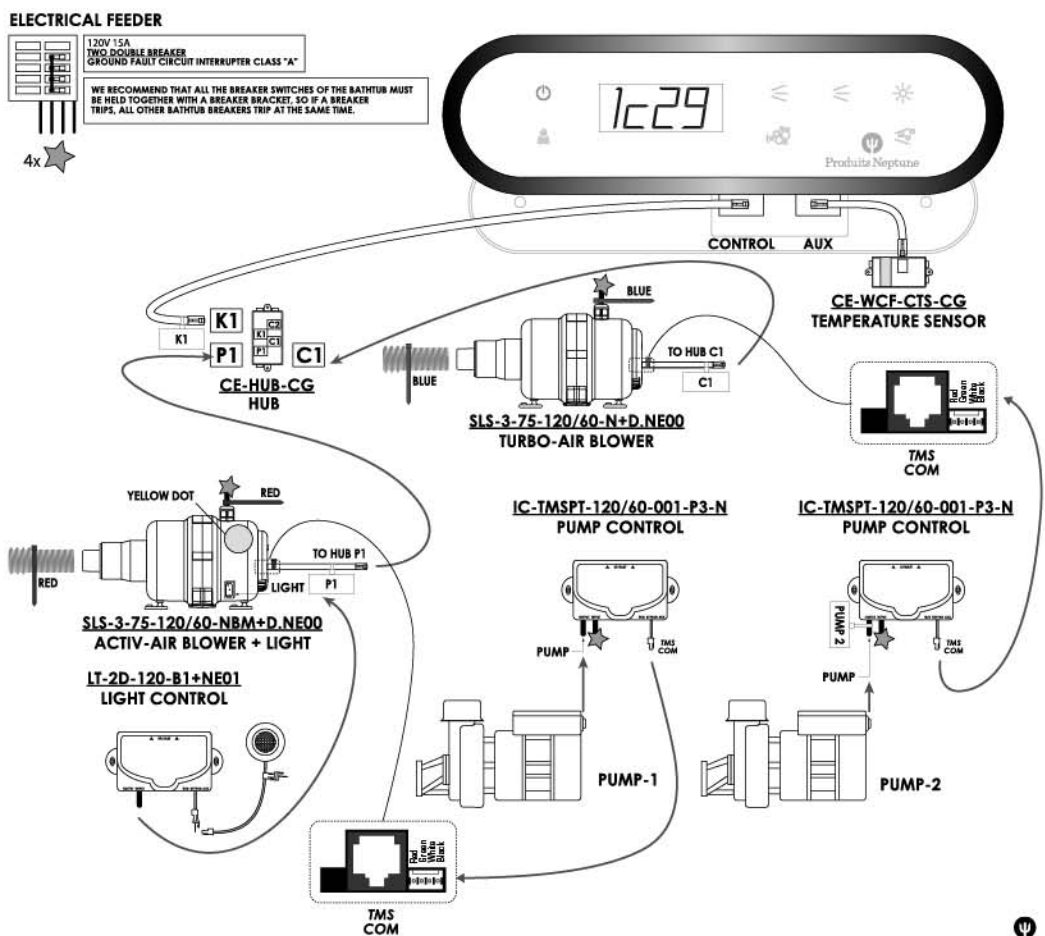
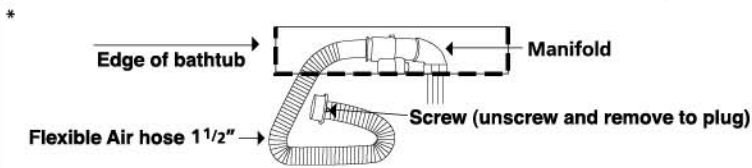
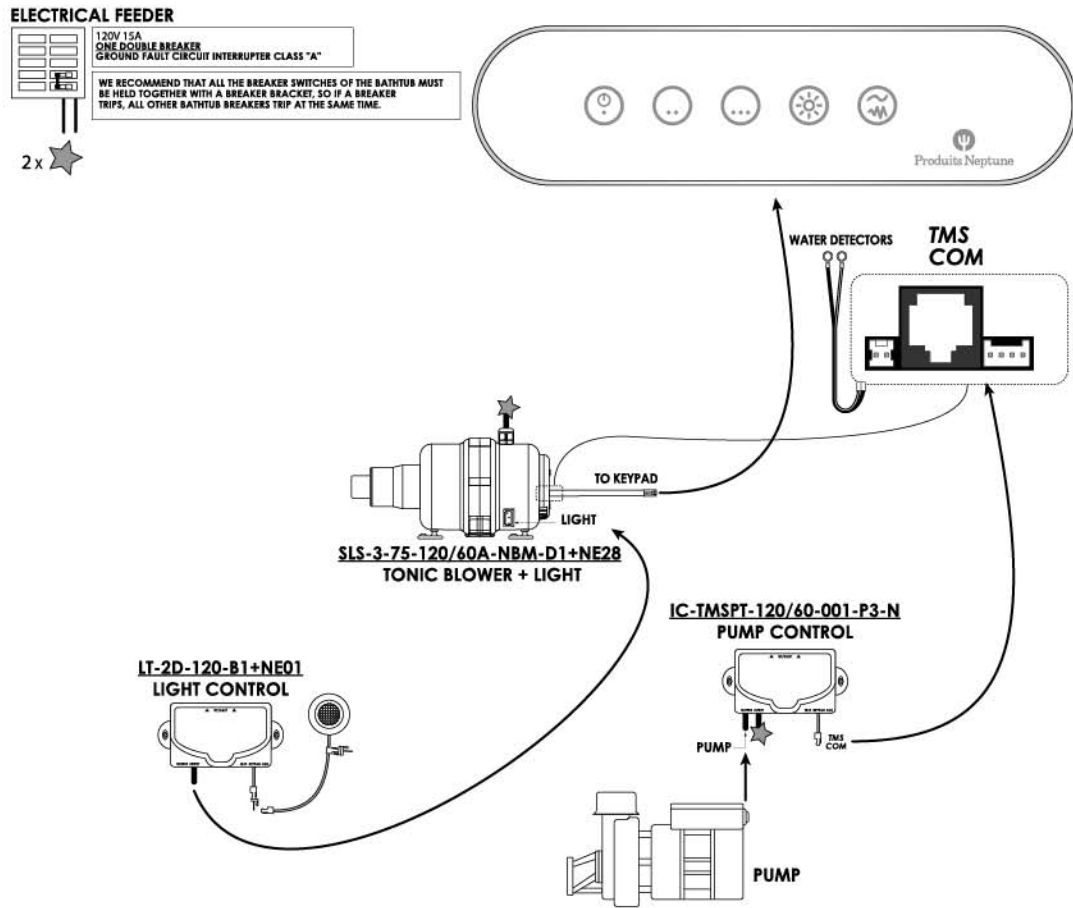

Fig. 60 Tonic



* In the case of a combo, connect flexible hose to blower adaptor.

Fig. 61

Inline Heater

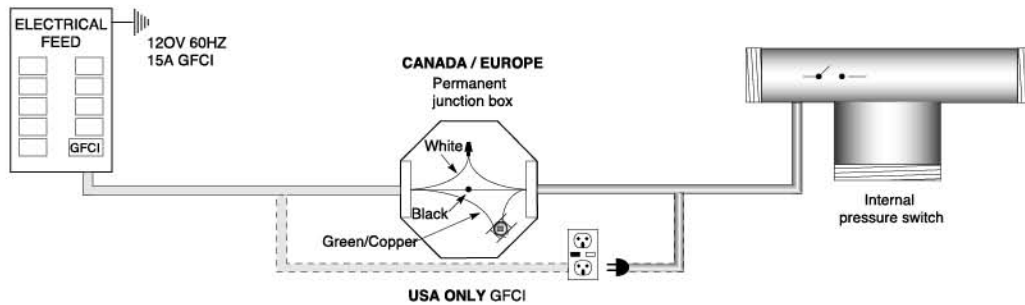

Fig. 62 Whirlpool + light

ELECTRICAL FEEDER

120V 15A
ONE POLE BREAKER
GROUND FAULT CIRCUIT INTERRUPTER CLASS "A"

WE RECOMMEND THAT ALL BREAKERS SWITCHES OF THE BATHTUB MUST BE HOUD TOGETHER WITH A BREAKER BRACKET, SO IF A BREAKER TRIPS ALL OTHER BATHTUB BREAKERS TRIP AT THE SAME TIME.

2x ⚡

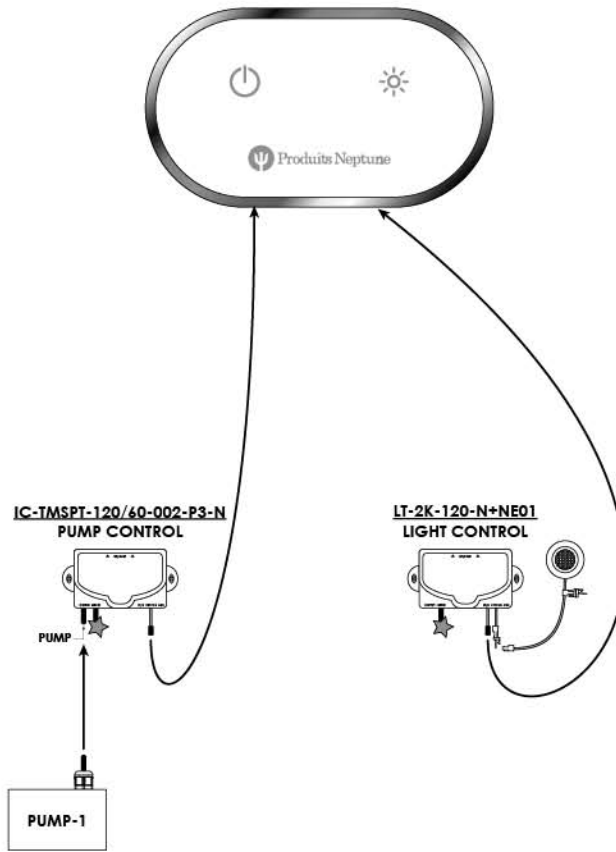
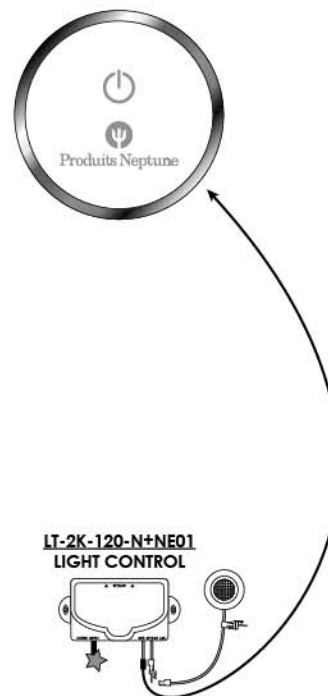

Fig.63 Chromotherapy

ELECTRICAL FEEDER

120V 15A
SINGLE BREAKER
GROUND FAULT CIRCUIT INTERRUPTER CLASS "A"

1x ⚡



Ozonator

TAMING THE ELEMENTS

Hygiene has always been a main concern for the consumer when purchasing a bathtub with a massage system, and it has always been our main concern when we develop any new product. Up till now, no one had found the solution to tame nature's special elements in a way that is safe and practical for use in the bathtub industry while taking full advantage of the powerful oxidizing and disinfecting properties of ozone in a whirlpool or an air system.

BASICALLY, YOU DON'T WANT TO BE DISINFECTED, YOU WANT YOUR BATHTUB SYSTEM TO BE

It was essential to us to find a way to thoroughly sanitize the entire bathtub system, whether it be whirlpool or air channel system without necessarily having the bather caught in the middle like in the method currently used in the bathtub industry. The majority of ozonators available on the market function with the venturi effect of the whirlpool pump to inject the ozone within the system. Therefore the bathtub must be full of water and the whirlpool system must be in function. The ozone that is injected within the system loses most of its efficiency for the sanitization of the piping of the whirlpool system because the majority of the ozone concentration is used to sanitize the bathtub water. Furthermore, a venturi system is incapable of generating as much concentration of ozone as with a compressor system.

IT IS THE SYSTEM THAT WE ARE SANITIZING, NOT THE BATHER

The O₃ System eliminates this worrisome factor by completely sanitizing every inch of the air channel and/or whirlpool piping immediately after each use thus preventing the possible colonization of bacteria and micro-organisms.

Even though ozone is not a harmful gas when used in such a small concentration for bathtub sanitization, we have made it so that the system will only start under certain conditions and it will never be possible to start otherwise. How our system works:

- When the probes detect water in the bathtub, the O₃ System automatically activates the waiting mode until the bathtub is emptied.
- Once the O₃ System has detected an absence of water, the O₃ System turns on a one hour delay timer. The O₃ System will then start the cleaning process for a period of 15 minutes to sanitize the whirlpool piping and/or the air channel of your bathtub massage system.
- When the sanitization cycle is finished, the O₃ System will automatically turn off until another water detection occurs within the bathtub.

There are 2 security levels incorporated within the system. A loop of piping at the module level and a security check-valve. These 2 security levels prevent water backflow within the O₃ System and its components. No maintenance is necessary for the O₃ System.



GFCI Breaker
15A /120v

FINISHING WALLS, DECKS AND PODIUMS

Now that you have installed and tested your bathtub and its systems, the following pointers will help you achieve a professional looking and watertight finish:

- Fig. 64 shows how the finishing materials should be installed relative to the tiling flange.

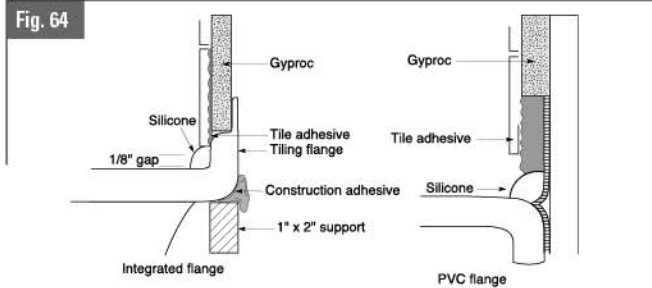

- The tiling flange does not replace caulking. Always caulk your bathtub using good quality, bathroom grade (mildew resistant) silicone caulk.
- Fig. 65 shows how the finishing materials should be installed relative to the bathtub lip on a podium or deck installation.

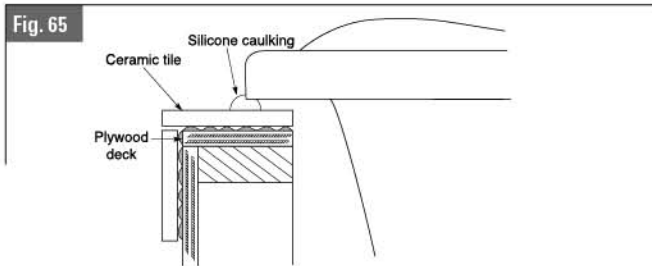

- All 90° angles including those between the walls, the podium and the deck should be sealed with silicone caulk (see fig. 66).

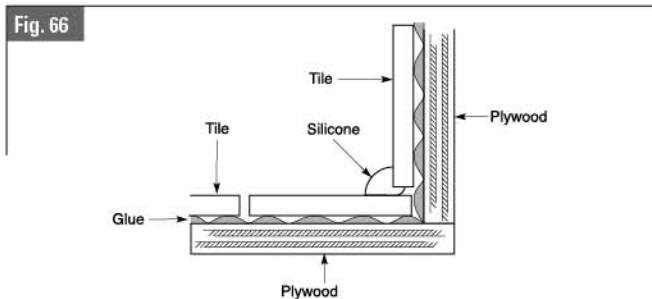

OPTIONAL BATHTUB SKIRT INSTALLATION

Optional bathtub skirts are available for many Produits Neptune bathtubs. There are two general types: fixed height aprons such as those for ZEN, ZORA, DELIGHT, HELENA and DAPHNE bathtubs, and adjustable height skirts such as those for ARIANE, ORPHEE, THALASSA and VENUS bathtubs. All skirts are designed 7/8" shorter than the bathtub on either side. This is to allow for removal of the skirt after the walls have been finished. Follow the instructions that match your type of skirt.

FIXED HEIGHT SKIRTS

The bathtub must be installed at a specific height in order for the skirt to fit properly. Refer to table 1 on page 4 to find the correct height for your bathtub.

The skirt is comprised of 3 components, 2 blocks marked "left" and "right" and the skirt itself (see fig. 67).

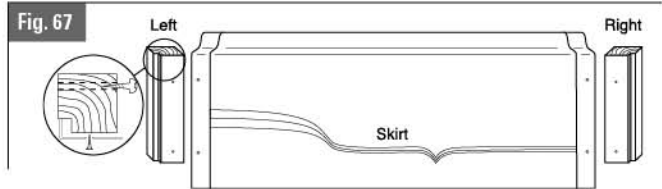

- **Step 1:** Screw the two (2) blocks marked « left » and « right », they must be flush with the lip of the bathtub and vertically level to the wall stud (see fig. 69). Screw the two (2) blocks marked "left" and "right" on the inside of the previously drawn line. These blocks must be level with the bathtub lip and vertically at the level of the wall stud (see Fig. 70). The surface that the blocks are affixed to must be the same one that supports the bathtub. (e.g., 2 x 4 or gyproc)
- **Step 2:** Set the skirt in place by pushing it up and behind the lip of the bathtub (see Fig. 71). If you install the bathtub at the correct height it will be a snug fit between the floor and the bottom of the bathtub lip.
- **Step 3:** Attach it to the two side blocks using screws through the holes in the skirt (see fig. 72). Install the caps on the screws.

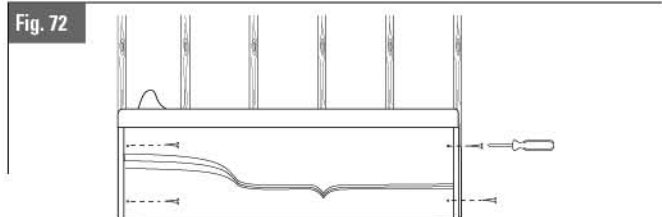
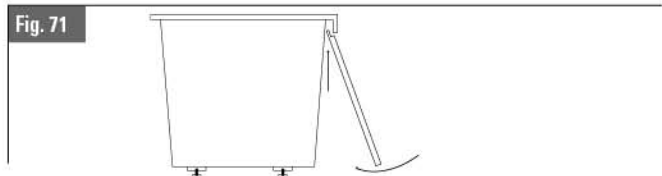
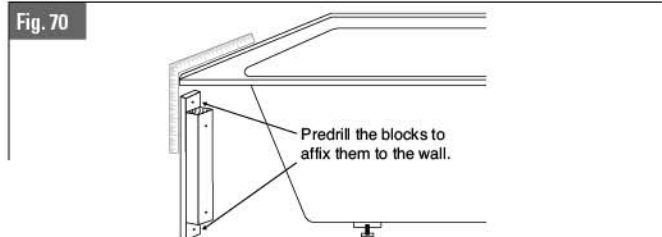
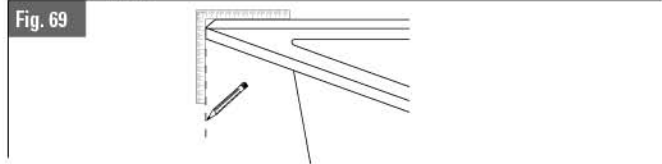
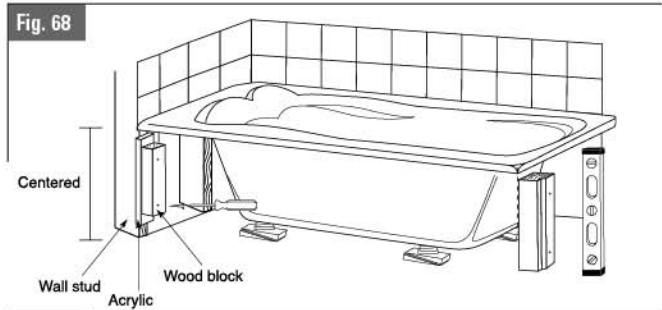

NOTE: A) When the skirt is installed, there will be a 1/16" to 1/8" gap between the finished flooring and the bottom of the skirt. This gap must be concealed by a silicone joint.

B) The structure in this type of installation is not designed to sit on the edge of the bathtub, acrylic skirt may crack.

ADJUSTABLE HEIGHT SKIRTS

The skirt is comprised of 4 components, the L shaped bracket that screws to the floor, 2 blocks marked "left" and "right" and the apron (see fig. 73).

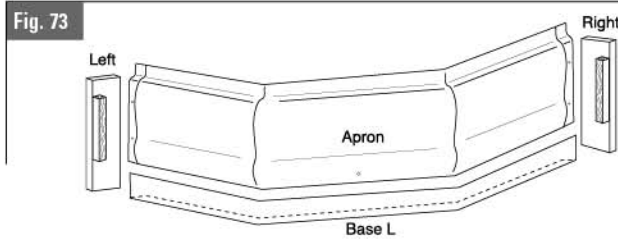

- **Step 1:** Install the two blocks marked "left" and "right", they must be flush with the lip of the bathtub and vertically level (see fig. 74).

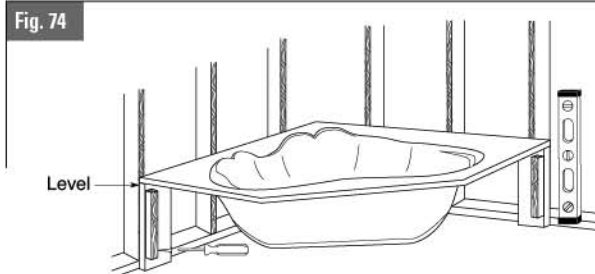

- **Step 2:** Position the L-shaped base 22mm (7/8") from the front of the blocks as shown in fig. 75 and fasten it to the floor with screws.

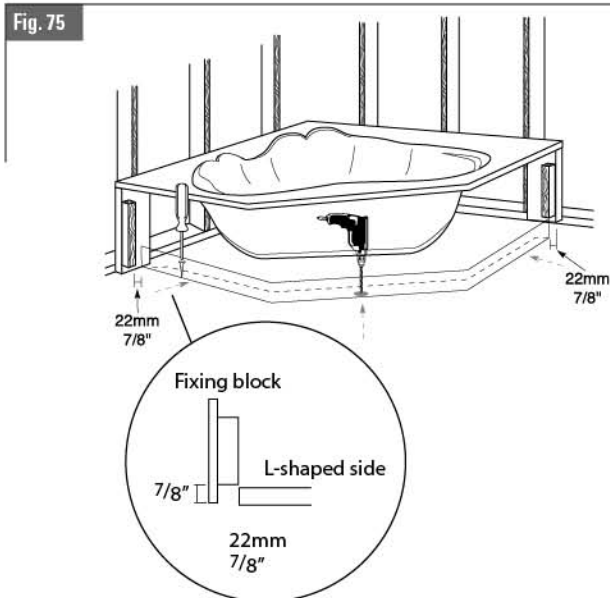

- **Step 3:** (2 people are required for this operation) Lift the skirt into place, flush under the lip of the bathtub. Attach it to the two side blocks using screws through the holes in the skirt (see fig. 76).

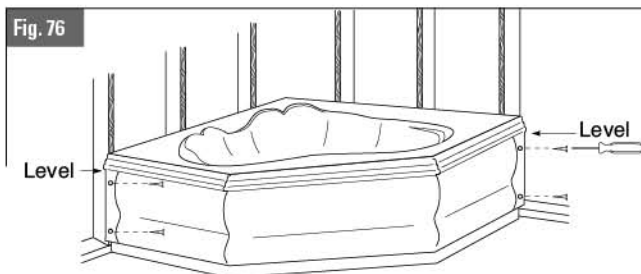

- **Step 4:** Make sure that the skirt is level at the center of the bathtub and that it tucks behind the lip. Screw the apron to the base through the hole in the center of the apron (see fig. 77).
- **Step 5:** Install the caps on the screws.

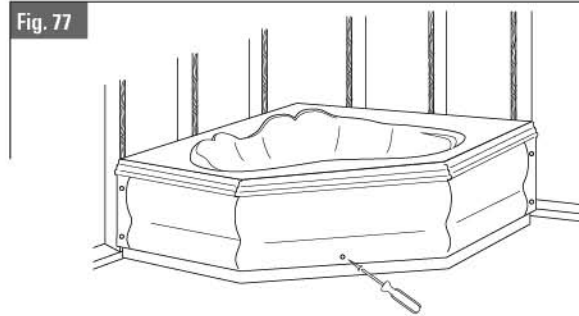

THALASSA SKIRT INSTALLATION

- **Step 1:** Make sure that the tub is installed at the correct height. There should be 18 1/2" from the floor to the bottom of the lip of the tub.
- **Step 2:** It is recommended that you put the skirt inside the skirt trim to verify its height before you install the skirt assembly.
- **Step 3:** Install the skirt trim by tucking the upper edges underneath the lip of the tub. Attach the skirt trim to the floor for stability. Attach each side to the wall, adding a piece of wood for stability if desired.
- **Step 4:** Install the skirt by tucking the upper edges underneath the lip of the tub. Attach the skirt to the skirt trim using the screws provided. Cover the screws heads with the caps provided.

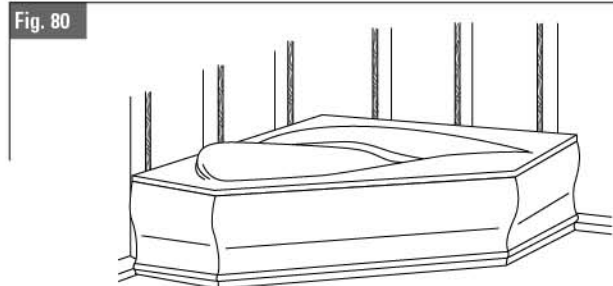
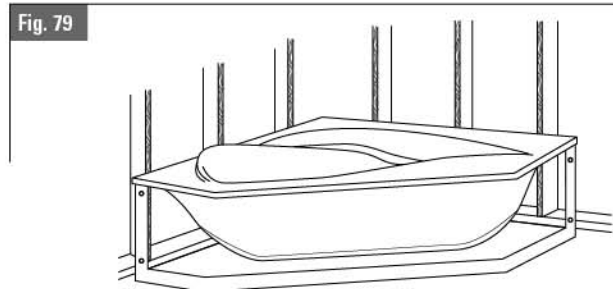
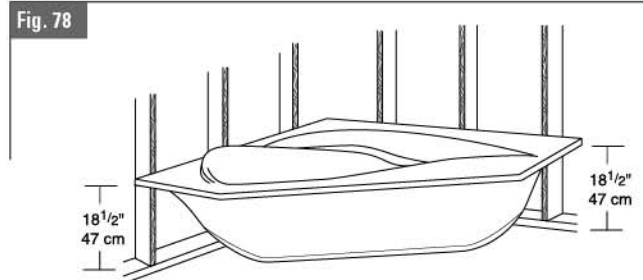

Operating instruction

WHIRLPOOL OR CHROMOTHERAPY ON/OFF CONTROL

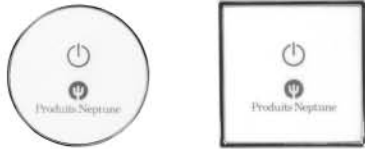

ACTION	PUMP/LIGHT(S)
1 st Touch	Starts
2 nd touch	Stops

WHIRLPOOL OR CHROMOTHERAPY ON/OFF CONTROL



ACTION	PUMP	LIGHT(S)
1 st Touch	Starts	Starts
2 nd Touch	Stops	Stops

MASS-AIR, ACTIV-AIR AND COMBO CONTROL



BUTTON	ACTION	FUNCTION	LED	SCREEN DISPLAY
1 ON/OFF	1 st	Light to 50% the LED of the buttons available for this configuration. The 20 minute timer countdown will be engaged when the blower and/or the pump and/or the light will be started. STANDARD DISPLAY Screen display will indicate the timer and the temperature alternately.	ON-100%	20 ^{°C} 104 ^{°F}
	2 nd	Stops all activated functions and closes the button's LED.	OFF	OFF
	-	Control will stop automatically if no device is activated after 5 minutes.	OFF	OFF
	-	If water detector is not detecting water "H2O" will display on screen.		H2O
	-	If the bathtub was filled up before connecting and activating the control, "H2O" will display on screen.		H2O
	-	If "H2O" is displaying on screen and there is water in the bathtub, there is a problem with the temperature/water detector. It will have to be replaced.	-	H2O
	-	If the temperature/water detector is not connected or defect, "--°C" or "--°F" will display on screen. In this condition the system will not work. Check first the connection: if it is well connected, replace the cable between the keyboard and the temperature/water detector. If that still doesn't work, replace the water detector.	-	--°C --°F
	-	If there is a communication problem with the temperature/water detector "H2O °C" ou "H2O °F" will display on screen. Start by checking if it is the cable which is defective by replacing it, if "H2O °C" or "H2O °F" is still displaying on the screen, then the temperature/water detector which will have to be replaced.	-	H2O °C H2O °F
Press and hold 5 sec.	TO SELECT THE TEMPERATURE MODE (no water in tub is needed) With the close control press and hold the button for 5 seconds. Screen will display °F or °C to change the temperature mode. Simply press one more time on button #1 to alternate between °F and °C. Once the desired mode is selected, wait 5 seconds, the symbol will flash 2 times and will automatically be saved.	ON-100%	0F °F 0C °C	

BUTTON	ACTION	FUNCTION	LED	SCREEN DISPLAY
2 USAGER	1 st	User – 1	ON-100 %	
	2 nd	User – 2	ON-100 %	
	3 rd	User – 3	ON-100 %	
	4 th	User – 4	ON-100 %	
	5 th	User – 5	ON-100 %	
	Press and hold 2 sec.	SELECT A USER When the user's number you wish to select is on screen, press and hold the button for 2 seconds. A "u" will appear beside the "2" on the screen display, release the button. "u2" will flash two times to indicate user has been selected and user's functions will start. Return to standard display.	ON-100 %	
	Press and hold 5 sec.	SAVE FUNCTIONS INTO A USER Start devices with the desired functions. When the user's number on which you wish to save is on screen, press and hold the button for 5 seconds. A "S" will appear beside the "u2" on the screen display, release the button. "Su2" will flash two times to indicate user's setting has been saved. Return to standard display.	ON-100 %	
	-	To indicate if some settings have been saved or not into a user, when you will scroll into the users, a "no" will display beside the user number to indicate there are no setting saved..	-	
	-	You cannot select a user with no saved settings. If you try, the user icon and number will stay on screen and "no" will flash 2 times.	-	
	-	If you wish to erase the saved settings into a user, you simply have to stop all devices, select the user you wish to erase and save. "no" will display to indicate there is nothing saved in this user.	-	
	-	If you are in a user and you change the settings, the user's number will flash slowly every 3 seconds to indicate the user's settings have been changed. It is possible to save the changes by pressing the user's button for 5 seconds.	-	
	-	When you select a user, if devices are already in function, they will stop and then restarted, if needed, to user's settings.	-	
-	There are 5 users available. By default, no settings are saved into the users.	-		
-	The 20 minutes timer countdown will be reset and restart to 20 minutes when a user is selected.	-		
BUTTON	ACTION	FUNCTION	LED	SCREEN DISPLAY
3 ON/OFF POMPE - 1	1 st	Pump 1 starts at speed 1 / Maximum	ON-100 %	
	2 nd or hold 1 sec.	Pump 1 stops	ON-50 %	Standard display

BUTTON	ACTION	FUNCTION	LED	SCREEN DISPLAY
4 SOUFFLEUR ACTIV-AIR	1 st	Blower 2 starts at speed 1 / Minimum	ON-100 %	SP1
	2 nd	Blower 2 starts at speed 2	ON-100 %	SP2
	3 rd	Blower 2 starts at speed 3	ON-100 %	SP3
	4 th	Blower 2 starts at speed 4	ON-100 %	SP4
	5 th	Blower 2 starts at speed 5	ON-100 %	SP5
	6 th	Blower 2 starts at speed 6 / Maximum	ON-100 %	SP6
	7 th	Wave mode	ON-100 %	J-1
	8 th	Pulsation mode	ON-100 %	J-2
	9 th or hold 1 sec.	Blower stops	ON-50 %	Standard display

BUTTON	ACTION	FUNCTION	LED	SCREEN DISPLAY
5 ON/OFF PUMP - 2	1 st	Pump 2 starts at speed 1 / Maximum	ON-100 %	SP1
	2 nd or hold 1 sec.	Pump 2 stops	ON-50 %	Standard display

BUTTON	ACTION	FUNCTION	LED	SCREEN DISPLAY
6 MASS-AIR BLOWER	1 st	Blower 1 starts at speed 1 / Minimum	ON-100 %	SP1
	2 nd	Blower 1 starts at speed 2	ON-100 %	SP2
	3 rd	Blower 1 starts at speed 3	ON-100 %	SP3
	4 th	Blower 1 starts at speed 4	ON-100 %	SP4
	5 th	Blower 1 starts at speed 5	ON-100 %	SP5
	6 th	Blower 1 starts at speed 6 / Maximum	ON-100 %	SP6
	7 th	Wave mode	ON-100 %	J-1
	8 th	Pulsation mode	ON-100 %	J-2
	9 th or hold 1 sec.	Blower stops	ON-50 %	Standard display

BUTTON	ACTION	FUNCTION	LED	SCREEN DISPLAY
7 LIGHT	1 st	Starts lights in white	ON-100 %	[1]
	2 nd	Slow rainbow mode	ON-100 %	┌┐ 1
	3 rd	Stops on desired color	ON-100 %	---
	4 th	Aqua	ON-100 %	[2]
	5 th	Blue	ON-100 %	[3]
	6 th	Magenta	ON-100 %	[4]
	7 th	Red	ON-100 %	[5]
	8 th	Orange	ON-100 %	[6]
	9 th	Yellow	ON-100 %	[7]
	10 th	Green	ON-100 %	[8]
	11 th or hold 1 sec.	Stops lights	ON-50 %	Standard display

BUTTON	ACTION	FUNCTION	LED	SCREEN DISPLAY
8 TURBO-AIR BLOWER	1 st	Blower 2 starts at speed 1 / Minimum	ON-100 %	SP 1
	2 nd	Blower 2 starts at speed 2	ON-100 %	SP 2
	3 rd	Blower 2 starts at speed 3	ON-100 %	SP 3
	4 th	Blower 2 starts at speed 4	ON-100 %	SP 4
	5 th	Blower 2 starts at speed 5	ON-100 %	SP 5
	6 th	Blower 2 starts at speed 6 / Maximum	ON-100 %	SP 6
	7 th	Wave mode	ON-100 %	┌┐ 1
	8 th	Pulsation mode	ON-100 %	┌┐ 2
	9 th or hold 1 sec.	Blower 2 stops	ON-50 %	Standard display

Drying cycles for air systems

A one minute drying cycle will activate 20 minutes after the bathtub is drained, even if no system has been working.

Water detector

Will prevent the pump(s) to start if there is not enough water in the bathtub.

○ ACTIVE DEVICES



LAST USED DEVICE STATUS WILL REMAIN DISPLAYED FOR 5 SECONDS

AFTER STANDARD DISPLAY WILL APPEAR
TIMER AND TEMPERATURE ALTERNATELY



WHIRLPOOL: ADJUSTABLE JETS

Produits Neptune whirlpool jets have two adjustable features, direction and flow. Direction is adjusted by simply moving the nozzle to point in the desired direction. Flow is adjusted by rotating the nozzle (see fig. 81) or the face plate for the Maxima jet.

Turning the nozzle or face plate clockwise reduces flow and turning it counter-clockwise increases it.

Fig. 81

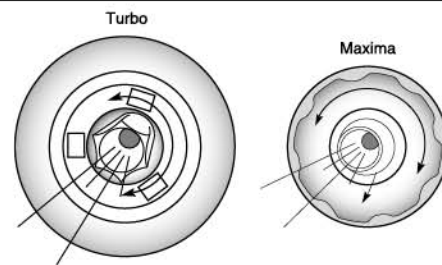

WHIRLPOOL: AIR INDUCTION

Produits Neptune's whirlpool system increases the massaging effect by drawing air into the jets (VENTURI EFFECT). The air controls are directly installed on the whirlpool system piping.

BACKJETS: DIVERTER VALVE (option)

Some Produits Neptune bathtubs that have backjets or 2 jets neck cushion option are equipped with an optional diverter valve. This valve (see fig. 82) redirects flow from the main jets to the back-jets allowing you to balance the massage to the point where you enjoy it the most.

Fig. 82

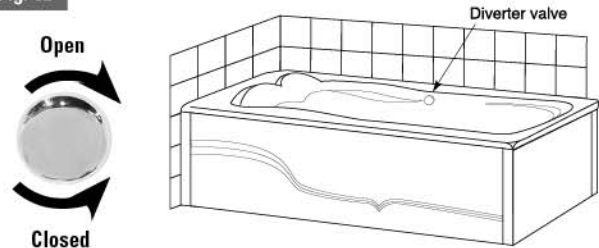

TONIC CONTROLS



Tonic System along with Oxygen jet will operate an ON/OFF pump, a variable speed blower and lights from the same keypad.

BUTTON	PRESS	FUNCTION	LED
1 ON/OFF MINIMUM	1st	If you touch the ON/OFF button, all LED will lit semi-intensity.	ON
	2nd	If you touch the ON/OFF button, the button will lit at 100% and the system will start in low intensity.	ON
	3rd	If you touch the system, it will be in pulse low intensity.	ON
	4th	If you touch the system, it will reach ON/OFF semi-intensity.	ON
2 ON/OFF MEDIUM	1st	Simultaneously starts blower and pump at medium speed.	ON
	2nd	Medium pulsation mode (See graph)	Blink
	3rd or hold for 1 sec.	Stops blower and pump.	OFF
3 ON/OFF MAXIMUM	1st	Simultaneously starts blower and pump at maximum speed	ON
	2nd	Maximum pulsation mode (See graph)	Blink
	3rd or hold for 1 sec.	Stops blower and pump.	OFF
4 ON/OFF LIGHT	1st	Light starts in White, Orange, Slow rainbow mode, Stop on shown color, Aqua, Blue, Magenta, Red, Yellow, Green, Off > LED OFF	ON
	Hold for 1 sec.	Stops LED	OFF
5 SOFT AND DYNAMIC MESSAGES	1st	SOFT MESSAGE Blower and pump start at minimum pulsation mode. Light starts in blue and slowly changes to Aqua, then Green and returns to Aqua. Colors change simultaneously with the pulse. (See graph)	ON
	2nd	DYNAMIC MESSAGE Blower and pump start at maximum pulsation mode. Light starts in Orange and slowly changes to Red, then Magenta and returns to Orange. Colors change simultaneously with the pulse. (See graph)	ON
	3rd or hold for 1 sec.	Stops LED, pump and blower	OFF

ADDITIONAL INFORMATION

- To activate the system and to light all buttons to a semi-intensity, you have to press on the ON/OFF button.
- All touches will lit at semi-intensity at the start of the system, if no function is activated after 5 minutes, the control will be back to OFF.
- When you activate functions and close them afterward, all buttons will be lit to a semi-intensity for 5 minutes.
- The purge will not change anything to the above function and vice-versa.
- The keypad will remain backlit after use for a 5-minute period after the purge cycle.
- 8 jets and 4 lights per system.
- Can switch from one mode to another without turning it off.
Ex: Can switch from minimum mode to maximum mode without turning minimum mode off.
- If the customer wants to turn on the Soft or Dynamic mode, the system will turn off by itself for few seconds and will restart in the desired mode.
- 20 minute timer.

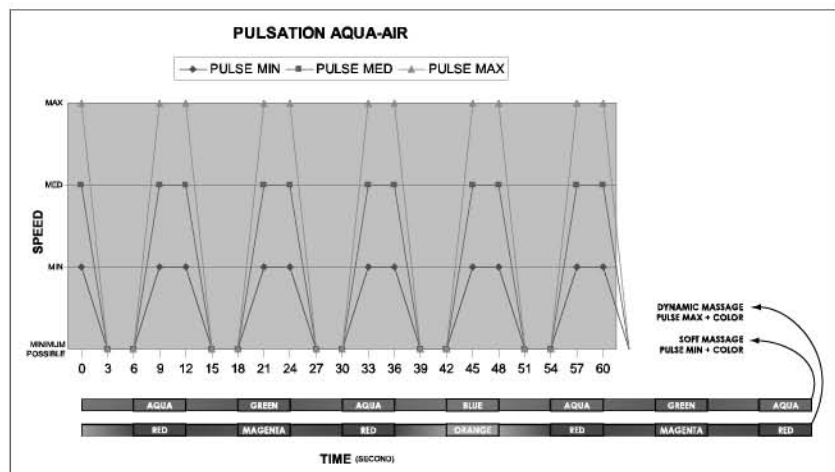

SHOWER AND SHOWER BASE INSTALLATION

Please read carefully all of the installation and maintenance instructions contained in this guide. We strongly recommend the installation being done by a qualified and authorized specialist, in accordance with building codes and laws.

This quality product was thoroughly inspected in factory against any manufacturing defect before being packed. However, if this product is defective, do not proceed to the installation and inform your retailer immediately.

The installation of a defective product or a bad installation cancels the manufacturer's guarantee. To honor your guarantee, you must keep your purchase invoice or provide us a proof of purchase by referring to your retailer. The Produits Neptune guarantee (for life on any manufacturing defect of all the acrylic products) is nontransferable.

BEFORE BEGINNING

Before installing your new PRODUITS NEPTUNE shower, we strongly recommend you to follow these few simple steps.

- Prior to removing your old shower, carefully inspect the new one for damage. Do not install a damaged unit. Please contact your local representative for assistance.
- Make sure that the shower you have is the one you ordered and that the dimensions are exact.
- Ensure plumbing rough-in for both the drain and the supply lines are completed according to your shower or shower base's dimensions.
- The floor area where your shower will be installed must be structurally sound and strong enough to hold the shower and an adult's weight. Also make sure that the walls and floor are square, plumb and level. If need be, level the floor with floor leveler.
- It is essential to have an access panel for plumbing maintenance. The building code generally requires the installation of an access panel of a minimum of 30 X 50 cm to facilitate plumbing maintenance.

NECESSARY TOOLS

- | | | |
|--------------------|----------------|--------------|
| • Safety glasses | • Tape measure | • Set square |
| • Drill | • Level | • Drill bit |
| • Screwdriver | • Hammer | |
| • Paper and pencil | • Pipe wrench | |

NECESSARY MATERIALS

- Silicone sealant (mildew resistant)
- Construction glue
- Shims (cedar shingles)
- Standard or self-drilling screws
- Mortar (optional)

PREPARATION OF THE SITE

- Sweep the floor to remove construction debris and vacuum to remove all remaining dust.
- If renovating, remove all existing wall material in order to install shower directly on wall studs.
- Make sure that the wood frame has the appropriate dimensions.
- If you plan on installing a door, you will also need to plan studs to receive the fastener screws when installing the jambs. Please refer to the installation guide provided with the door.
- All plumbing rough-in for both the drain and the supply should be completed before installing the shower.
- Check the distance between the wall, the shower and the studs to ensure that your valves and fittings fit well.

ROOF CAP INSTALLATION

If you chose the roof cap option, it must be installed before the shower is fixed to the walls. (see fig. 83)

If you did not choose this option, go straight to the SHOWER INSTALLATION step.

Fix the roof to the shower walls using the screws. The screws must screw in the shower's fixing lip and be anchored in the block of wood which was installed to the roof beforehand. Apply a silicone bead between the two parts. Do not use screws that are too long. (see fig. 84)

Fig. 83

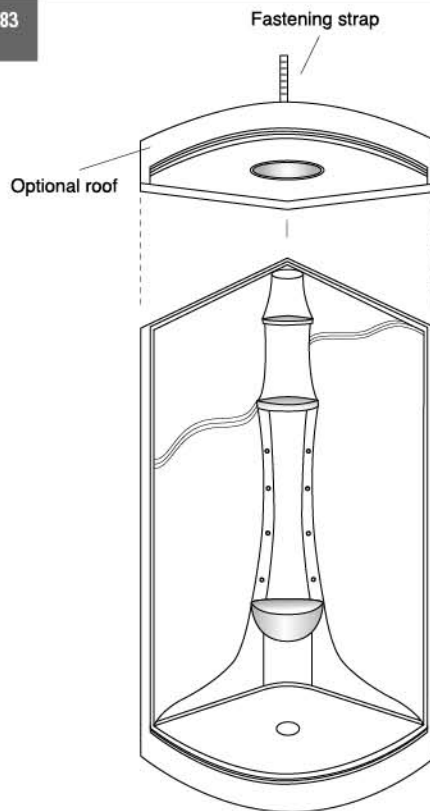
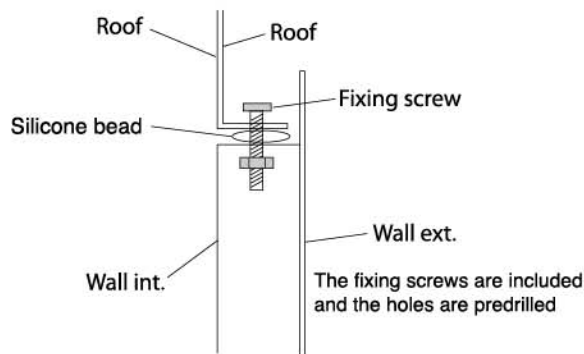

Fig. 84

Roof Installation



SHOWER INSTALLATION

Ensure walls and floor are square, plumb and level. All plumbing rough-in for both the drain and the supply should be completed before installing the shower. Also, make sure that you have an access in the back of the shower, on the same side as connections for valves and fittings. (see fig. 86)

To fix shower to the walls, use self-drilling screws through the shower's fixing lip OR pre-drill holes to prevent acrylic from cracking.

Before the final installation of your waste or before installing faucets and trimmings, please verify all of the shower's axes*. Also, check drainage by pouring water down the shower's waste.

*a-b-c axes should all be of same length (see fig. 88).

Two piece showers:

You will need to separate the two (2) parts of the shower in order to apply a silicone bead for a better seal (see fig. 85).

Fig. 85 Two pieces model installation

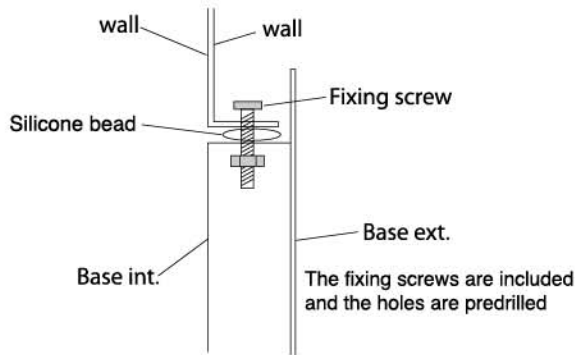

Fig. 86

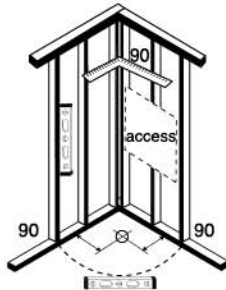

Fig. 87

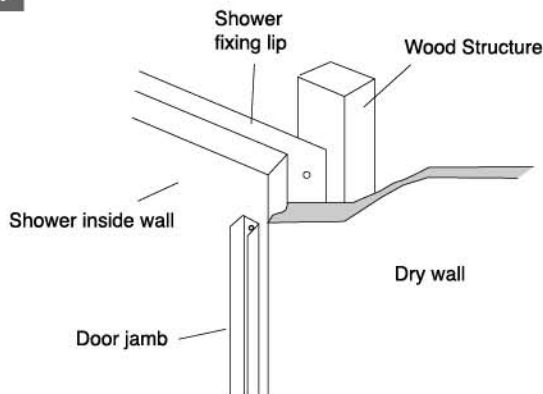
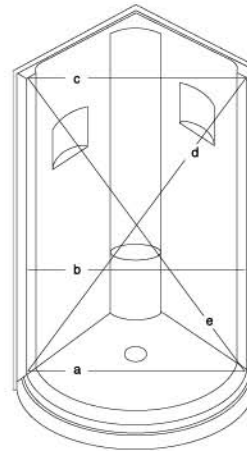

Fig. 88



SHOWER BASE INSTALLATION

Ensure walls and floor are square, plumb and level and that the waste pipes are well positioned. Position the unit in the prepared location and adjust level with wood shims or mortar. It will be easier to adjust the tray if you have access to it from the outside of the formwork. Before proceeding to the final installation, verify drainage by pouring water in the shower base.

Tray with tiling flange on 3 sides and corner tray

The sides with tiling flange must lean against the 2 x 4s. (see fig. 89)

Ceramic tiles must be flush with the base's interior walls, the walls must be perfectly square and the tray perfectly level in order to be able to adjust the doors correctly. (see fig. 90)

IMPORTANT!

Note that to install all basic shower models, the sides and feet of the base must be properly supported. It is strongly recommended that you rest the base on a mortar bed, make a structure to support the center (drain) of the base, or level the floor using a floor leveler.

SPACE Base

There is metal frame under the SPACE shower base. When installing the door, be very careful to not screw the U-shaped section to the acrylic base as this will damage it and void the warranty. For this type of installation, use double-sided tape.

KOYA Base

To ensure that the door on the KOYA base is properly installed, make sure that the base is level and the two acrylic side walls are perpendicular to it. If necessary, adjust with shims behind the walls and under the base. Make sure the ceramic is perfectly aligned with the interior of the acrylic walls.

LUNA Base

For proper installation of your LUNA shower, level the base in the back and on the side.

ZEN Base

3648, 3260, 3660 and 3636 round: use the fastening strap to fix the base to the walls.

Fig. 89

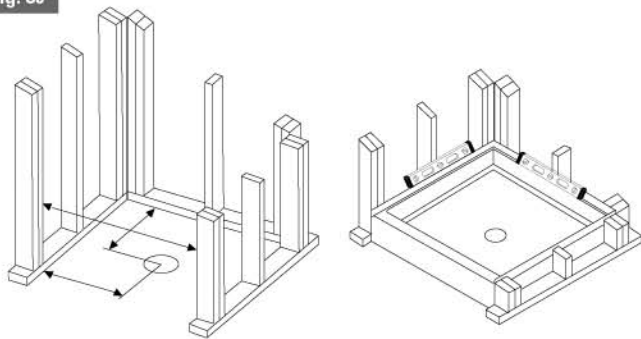
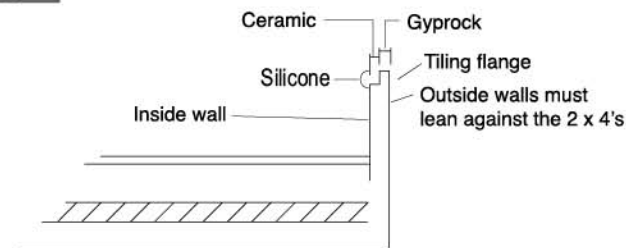

Fig. 90



WHIRLPOOL MAINTENANCE

Produits Neptune recommends that the following cleaning procedure be undertaken at least once per month.

1. Fill the bathtub with hot water 2 inches above the level of the jets.
2. Add 2-Cups of vinegar or 1/4 cup of liquid dishwasher soap.
3. Run the whirlpool for approximately 5 minutes.
4. Let the bathtub soak for a 1/2 hour.
5. Run the whirlpool for another 5 minutes.
6. Drain the bathtub.
7. Rinse with cold water.

MAXIMA JET

If a MAXIMA jet stops responding to adjustment commands, perhaps it has become unscrewed with usage. Follow these three (3) steps to fix this problem or when cleaning the jets. Note: MAXIMA jets are dishwasher friendly.

1. Unclip the head of the jet using a flat tool (like a ruler for instance). (see fig. 91A)
2. Remove head of jet. (see fig. 91B)
3. Using long-nose pliers, screw the body of the jet clockwise. To do so, insert one of the gripping jaws inside the notch (see fig. 91C), grip with the pliers and screw clockwise. Note: Do not over tighten. Clip head back on.

Maintenance

ROUTINE CLEANING

In order to protect the acrylic and polymer surface of your Produits Neptune bathtub and shower it should be cleaned only with a non-abrasive liquid bathroom cleaner such as liquid Spic and Span or a detergent formulated specifically for acrylic. NEVER USE ABRASIVE POWDER (VIM, AJAX etc.), PETROLEUM DISTILLATES OR OTHER STRONG SOLVENTS TO CLEAN THE SURFACE OF YOUR BATHTUB OR SHOWER.

MASS-AIR AND ACTIV-AIR SYSTEMS

If your Produits Neptune bathtub is fitted with either a Mass-Air or Activ-Air therapeutic system most of the routine maintenance is eliminated by the fact that the electronic control module has a built-in automatic drying cycle. This cycle, that initiates 20 minutes after the blower has stopped, removes all remaining stagnant water from the air jets, return valves and piping thus keeping them dry. If your bathtub is often used without activating the system, it should be momentarily activated so that the drying cycle will initiate.

Fig. 91

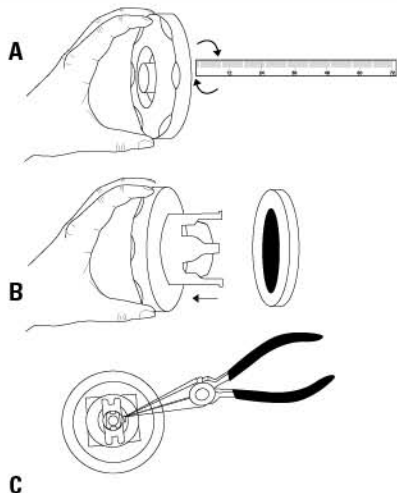

Acrylic repairs

STAIN

If you have a particularly resistant stain, you can use isopropyl alcohol to try and remove it (isopropyl alcohol is toxic, so always follow the safety instructions that come with it and wear rubber gloves).

MINOR SCRATCH REPAIR

Small superficial scratches can usually be removed by using an automotive polishing compound such as NuFinish or Meguiar's mirror glaze.

MAJOR DAMAGE REPAIR

Major damage, including chips and cracks in your bathtub, can often be repaired by a qualified technician. Your Produits Neptune dealer can put you in contact with such a qualified professional.

Troubleshooting

PROBLEM	SOLUTION
Water remains around the bathtub rim or drain.	Check that the installation is level and that the bathtub is sitting firmly on its feet. (Drain slope is built into the bathtub.) Shim with adjustment wedges if necessary.
Bathtub or shower bottom moves during use.	The bathtub is not sitting firmly on its feet. Shim with adjustment wedges or use the alternate mortar bed installation technique.
Bathtub moves relative to the walls during use.	The bathtub is not firmly supported under the rim. Check that 1"X2" supports contact the underside of the rim. Modify if necessary.
Protective plastic film will not come off.	Use isopropyl alcohol.
Electronic control fails to operate.	<ul style="list-style-type: none"> • Check the electrical power supply. Reset circuit or replace fuse if necessary. • Check Ground Fault Circuit Interrupter (GFCI). Reset if tripped. • If the system has been in operation for a long time it is possible that the thermal protection switch has shut off the motor. Turn off the system and wait 30 minutes for it to cool, then try again. • Check the connections between the electronic control pad and the control module or pump.
Motor will not stop/ only some functions on the electronic control pad are working.	<ul style="list-style-type: none"> • Shut off power to the bathtub at the breaker. Make certain that no water has infiltrated the control pad. Try drying the pad with a hair dryer. • Check for excessive humidity under your bathtub and around the control pad and control module. Allow it to dry out and provide for adequate ventilation if necessary.
Excessive noise from blower or pump.	<ul style="list-style-type: none"> • Most of the noise from your Whirlpool, Mass-Air or Activ-Air system actually comes from the movement of the water. • Check that the blower is firmly secured. • Check that the pump is firmly in contact with the floor. Use adjustment shims and construction adhesive to secure if necessary. • Make certain that there are no obstructions close to the intake of the blower, and that it has an adequate supply of fresh air. • The bathtub can be insulated using bats of fiberglass around the tub. Make certain that you leave a 2 sq feet space around the pump or blower.
Blower runs but no air comes out through the jets.	Check that the main air hose from the blower to the manifold is properly connected. Reconnect and tighten clamps if necessary.
Air outlets in jet heads are blocked.	<ul style="list-style-type: none"> • If the air outlets of a jet head are obstructed with soap or other residues, fill the tub with water and brush them gently with a toothbrush. Turn the system ON then OFF several times. • Remove caps (Mass-Air & Activ-Air) and ball bearing and clean with cotton swabs. Use a rubber head hammer for reinstallation. • If the problem persists tap the jet heads with a spoon while the blower is running (Mass-Air system only).
The air heater seems not to be functioning. Note: The air heater is not designed to heat your bathwater, only to heat the incoming air to body temperature.	<ul style="list-style-type: none"> • To verify operation of the air heater, fill the bathtub to working level. Turn on the blower and let it run for approximately 5 minutes. Carefully feel the flexible connection hose where it connects to the blower. The hose should feel warm to the touch. If not, contact your local distributor. • If your bathtub is installed against exterior walls, make certain that they are properly insulated to minimize heat loss. The air entering the blower should be at least 200C. • Check that the blower is not drawing cold air from the basement or the space between the floors via the hole for the drain plumbing. Block the hole using either foam or fiberglass insulation. • People with sensitive skin might experience a "cold air effect" caused by the sensation of the air bubbles running along the wet skin and giving the bather a shivering sensation. Simply move the body slightly away from the closest jet.
the incoming air to body temperature. The air coming from the jets seem cold Temperature difference	<ul style="list-style-type: none"> • There will be a temperature difference between the air coming from the jets and the water temperature. The air temperature will be a little over the room temperature (22 to 25 degrees Celsius – 71 to 77 degrees Fahrenheit), depending on the number of jets in the bathtub. The water on the other hand, will be warmer (about 34 to 40 degrees Celsius – 93 to 104 degrees Fahrenheit). • The air is not cold: it is just not as warm as the bathtub water. If it weren't for the heating element that's in the blower, the temperature difference would be a lot greater.
"H2O" code displayed on the screen	<ul style="list-style-type: none"> • Make sure everything is connected, and that the ON/OFF control has been activated before filling up the bathtub. • Fill the tub about 3" above the water jet in order to have the water sensor work properly.

IMPORTANT INFORMATION TO SAFEGUARD

Note: Always keep your original bill of sale

Date of purchase: _____ Name of retailer: _____

Description of bathtub: _____

Serial # (indicated underneath the bathtub): _____

Warranty



Our warranty does not cover damage caused by:

Lightning, fire, excessive use, negligence, improper maintenance, essential oil, thermal shocks (flames, cigarettes, boiling water...), damages subsequent to delivery (knocks, transportation, handling...), bad usage and chemical or natural corrosion.

The pump, blower, plumbing system, jets and all other parts are guaranteed by each respective manufacturer. The pump or the blower must be connected to one circuit which is protected by a circuit breaker and equipped with a class A grounded leak detector. Anything which is altered or modified on any of Produits Neptune Inc. bathtubs or showers automatically cancels all warranties.

In case of a breakage, Produits Neptune Inc. must be advised within ten (10) days following the breakage.

The warranty is limited to either repairing or replacing the bathtub or shower, upon the manufacturer's decision. No indemnity shall be claimed from the manufacturer because of loss of enjoyment, time, revenue, sundry expenses, inconveniences, materials, labor or all other costs relative to any removal or replacement of a defective product.

No other understanding or implicit promise is part of this warranty.



PRODUITS NEPTUNE QUALITY

This logo certifies that your bathtub has been inspected and tested by our specialists and that it is compliant with our high Produits Neptune quality standards.



CSA LISTED/Warnock-Hersey

All our products and their components have received CSA or Warnock-Hersey certification, which attests to their quality and reliability.



UPC

IAPMO: All our porcelain products have received UPC certification.



WARRANTY

Each Produits Neptune product has been subjected to rigorous quality controls and we guarantee that it conforms to the highest quality standards. In order to ensure a trouble-free installation, we strongly recommend that you read the installation manual and our warranty terms joined with the product carefully before beginning any work. Our warranty covers parts and labor for repairs only and does not cover additional costs related to defective product replacement.

BATHTUBS & SHOWERS

ACRYLIC SHELL:

Limited lifetime warranty against manufacturing defects.

POLYMER SHELL:

Limited 5-year warranty against manufacturing defects.

SYSTEMS:

Limited 10-year warranty (parts and labor) against manufacturing defects; jets, pipes, fittings, electronic control pads, pumps, inline heaters, blowers, black box, remote controls, ozonator, wiring, etc. and leaks related to manufacturing defects.

Limited 5-year warranty against manufacturing defects related to colored jet trims inside the bathtub.

OPTIONS

WOOD TRIM:

Limited 1-year warranty against manufacturing defects.

GENERAL:

Chromotherapy, neck pillows, handles and other options.

Limited 5-year warranty against manufacturing defects for all parts.

METAL and FORGED IRON:

Limited 5-year warranty against manufacturing defects.

DOORS

Limited 10-year warranty against manufacturing defects, covers parts other than gaskets, magnets & installation hardware which have a 1-year warranty against manufacturing defects.

TOILETS

PORCELAIN:

Limited 5-year warranty against manufacturing defects.

PARTS:

Limited 5-year warranty against manufacturing defects for parts inside tank; Limited 1-year warranty for installation hardware.

SEATS:

Limited 1-year warranty against manufacturing defects.

SINKS

Limited 1-year warranty against manufacturing defects.

FAUCETS and DRAINS

Limited lifetime warranty against manufacturing defects on all parts including cartridges.

Limited lifetime warranty for chrome finish; 5-year warranty for brushed nickel finish.

FANS

Limited 3-year warranty against manufacturing defects, including heat lamps.

IMPORTANT !

- If a showroom product is sold, the warranty period begins on the date of purchase from Produits Neptune by the retailer.
- For commercial use, all products have a one-year warranty against manufacturing defects.
- The Produits Neptune warranty is solely for the personal household use of the original owner/user and starts on the date the product was manufactured. The warranty will take effect when the original owner/user presents the original bill of sale or the model serial number.

The warranty is not transferable to subsequent owners.

All products replaced or repaired during the warranty period will still be covered for the remainder of the original warranty.