

Please read the instructions completely before beginning the installation.

Allure Collection
 Model Number: 3356HK-TM

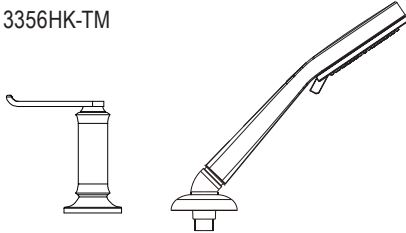

Bravo Collection
 Model Number: 6656BO-TM

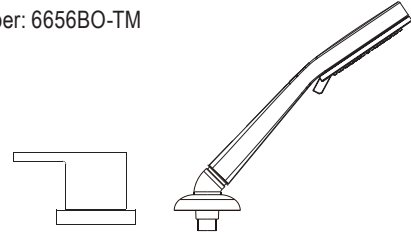

Britani Collection
 Model Number: 4156BL-TM

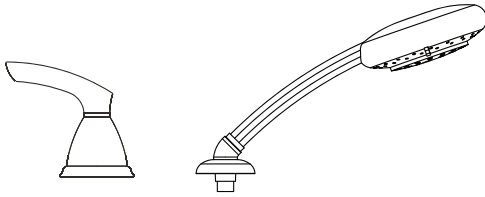

Chadwick Collection
 Model Number: 4356GL-TM

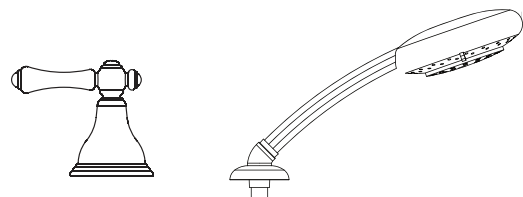

Ebis Collection
 Model Number: 3756HY-TM

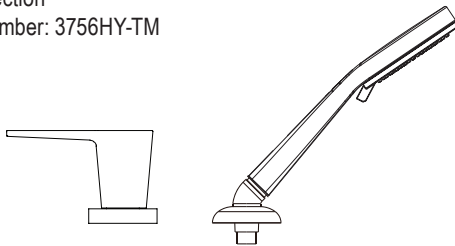

Element Collection
 Model Number: 3756HY-TM

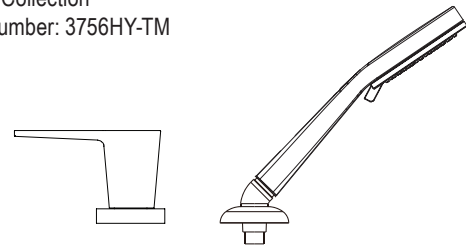

Lutti Collection
 Model Number: 4856PT-TM

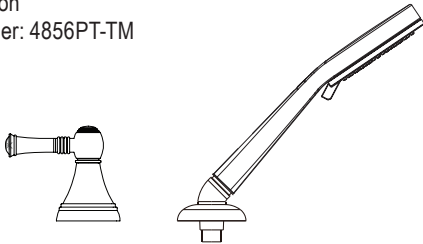

Metra Collection
 Model Number: 2456MD-TM

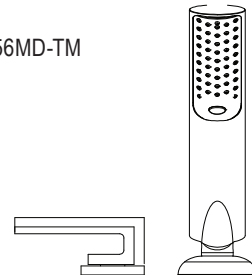

Flush both supply lines before installation, then shut off both supply lines.
 Minimum hole size for the spout and handle trim is 1-1/4" and maximum of 1-1/2"

The measurements shown are for reference only. Products and specifications shown are subject to change without notice.

www.santecfaucet.com | P: 310.542.0063 F: 310.542.5681

HANDLE TRIM INSTALLATION

1 - Unscrew pre-assembled handle trim from the valve body. Hot valve assembly "Red" to be mounted on left. Cold valve assembly "Blue" to be mounted on right.

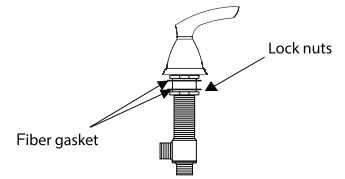

2 - Remove the top lock nut and the fiber gasket from the valve body.
- Apply a ring of silicone caulking around the handle hole on deck top.

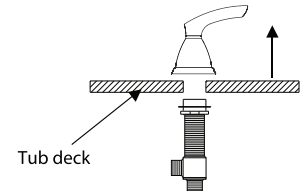

3 - Slip valve body up from below tub deck.
Place the top lock nut and the fiber gasket back onto the valve body until the top surface of the lock nut is flush with the top surface of the valve body.
- Secure the top lock nut in place before inserting the handle.

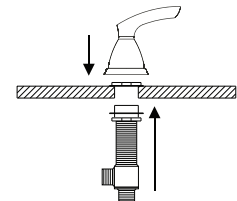

4 - Align handles with respect to the spout and tighten bottom lock nut until secure.

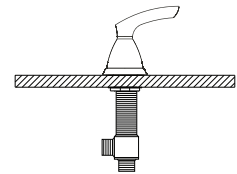

SPOUT TRIM INSTALLATION

1 - Remove the tee connector and spout mounting hardware from quick connect shank being sure to leave on brass plate.

2 - Apply a ring of silicone caulking around hole designated for spout.
- DO NOT USE PLUMBERS' PUTTY, WHICH CAN DAMAGE FINISH.

3 - From the top of the deck, slip the quick connect shank through the assigned spout hole.

4 - Secure the quick connect shank by putting the washer and lock nut back on the shank. Tighten the lock nut firmly.

5 - From the top of the deck, slip the spout with the flange and flange washer onto the quick connect shank top. Align the spout and tighten the set screw with the Allen key provided.

6 - Connect the tee connector to the spout shank.

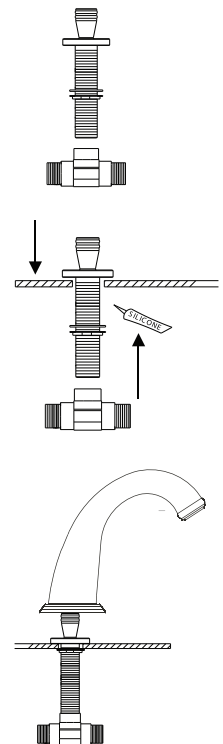

The measurements shown are for reference only. Products and specifications shown are subject to change without notice.

www.santecfaucet.com | P: 310.542.0063 F: 310.542.5681

HAND SHOWER INSTALLATION

- 1** - Apply a ring of silicone caulking around the hole designated for the hand held shower. Do not use plumber's putty, which can damage finish.

- 2** - Remove the hardware from Base Flange. Slip the Base Flange through the appropriate hole in deck. From underneath attach the Metal Washer and Brass Lock nut. Tighten firmly to avoid leakage.

- 3** - From underneath the deck attach the larger side of the 5/8" hose to the Spout Diverter valve. Slip the smaller end of the hose up through the base flange and connect to the hand held shower. Tighten both ends firmly to avoid leakage.

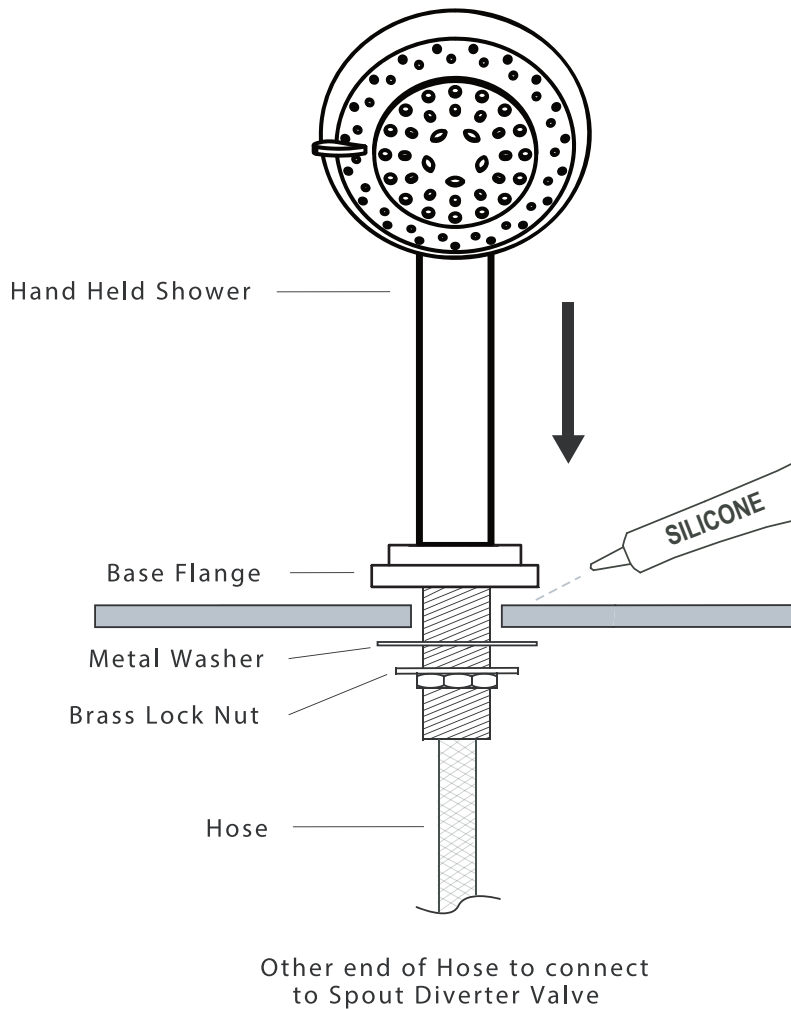

The measurements shown are for reference only. Products and specifications shown are subject to change without notice.

www.santecfaucet.com | P: 310.542.0063 F: 310.542.5681

PARTS DRAWING

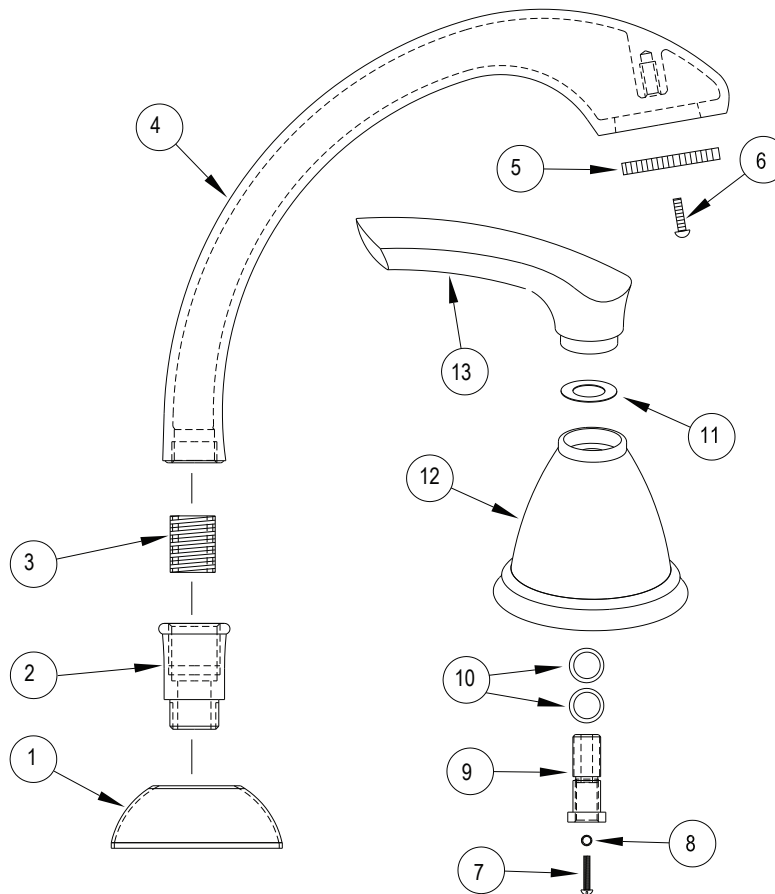

#	PART DESCRIPTION	PART #
1	Flange	HS-203
2	Adaptor	Z-200-4
3	All-Thread Connector	PM-Z13
4	Handheld Shower	Z-200-5
5	Spray Modulator	Z-200-6
6	Screw	Z-200-3
7	Screw	PM-181
8	Lock Washer	PM-184
9	Valve Extension	SA240
10	Teflon Washer (Small)	PM-099
11	Teflon Washer	PM-095
12	Bell	PH2545
13	Lever	PH2546

* Please specify the finish when ordering the part.

The measurements shown are for reference only. Products and specifications shown are subject to change without notice.

www.santecfaucet.com | P: 310.542.0063 F: 310.542.5681

SPECIFICATION SHEETS

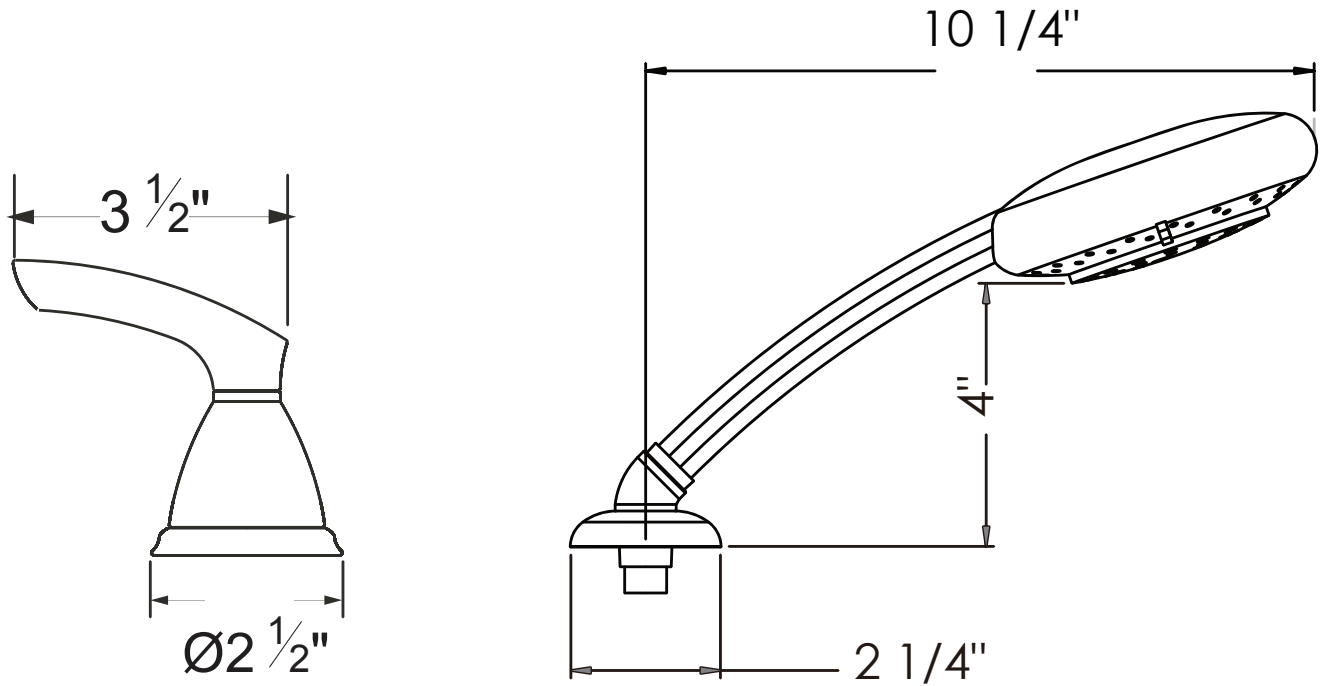

The measurements shown are for reference only. Products and specifications shown are subject to change without notice.
www.santecfaucet.com | P: 310.542.0063 F: 310.542.5681



FINISH CARE INFORMATION

WARNING: Do not clean your SANTEC product with ammonia (Window cleaner), bleach, soap, acids, abrasives, harsh polish, harsh cleaners, a coarse surfaced cloth, coarse sponge, or any type of scouring pad. Doing so may ruin your faucet finish and/or void the warranty.

Thank you for making SANTEC a part of your lifestyle and luxury spa experience. Our products have been created as works of enduring quality and sophisticated design.

Luxurious finishes need proper care and attention, so in order to understand how to properly clean your distinctive luxury finish, please refer to the finish care information below:

Your SANTEC product can be identified in one of two categories: clear coated finishes or non-clear coated finishes. Clear coated finishes are more scratch-sensitive and are more reactant to harsh cleaning chemicals than non-clear coated finishes. Once you have identified the specific luxury finish of your SANTEC product, please follow the important corresponding care instructions.

CLEAR COATED FINISHES

We recommend that all faucets, drains, etc., be gently wiped dry with a soft cloth after use to avoid water spotting and water deposit build-up. A mild liquid hand soap may be used occasionally if desired. Use of a non-abrasive carnauba wax will add protection to the finish and should be used if the faucets will not be dried after use. For clear coated finishes, it is recommended to clean your product weekly with a soft moist cloth.

NON-CLEAR COATED FINISHES

We recommend that all faucets, drains, etc., be gently wiped dry with a soft cloth after use to avoid water spotting and water deposit build-up. A mild liquid hand soap may be used occasionally if desired. Use of a non-abrasive carnauba wax is occasionally required and will add protection to the finish if the faucets will not be dried after use.

TO OBTAIN WARRANTY SERVICE

Please read 'WHAT IS COVERED BY OUR WARRANTY' and 'EXCLUSIONS AND LIMITATIONS OF WARRANTY' sections to understand what is and what is not covered. Please have ready the proof of purchase (original sales receipt), description of the problem, and carefully package the product or defective part with postage prepaid. Then, please contact your local SANTEC Showroom or write to SANTEC Technical Services.

The measurements shown are for reference only. Products and specifications shown are subject to change without notice.

www.santecfaucet.com | P: 310.542.0063 F: 310.542.5681



LIFETIME LIMITED WARRANTY

SANTEC is committed to enhancing your bathroom experience by creating luxury products that will provide enduring satisfaction. Every effort has been made to satisfy the highest standards of design and production, to create lasting peace of mind for our customers. We provide the following limited warranties on our products:

LENGTH OF WARRANTY & WHO IS COVERED BY OUR WARRANTY

This warranty extends to the original consumer purchaser only and extends for as long as the original purchaser owns the product and the home in which the product is installed.

WHAT IS COVERED BY OUR WARRANTY

1. **FINISHES:** SANTEC Polished Chrome, Polished Nickel and Satin Nickel finishes carry a Lifetime Limited warranty against manufacturing defects and tarnish to the original purchaser. All other finishes carry a ten (10) year limited warranty against manufacturing defects and tarnish to the original purchaser only.
2. **CARTRIDGES:** Santec cartridges carry a lifetime limited warranty, with the exception of thermostatic and pressure balanced cartridges, which carry a three (3) year limited warranty against manufacturing defects to the original purchaser.
3. **PARTS:** Santec parts carry a 10-year limited warranty against manufacturing defects, to the original purchaser.

EXCLUSIONS & LIMITATIONS OF WARRANTY

This warranty does not cover:

1. Damage due to negligence, accident, abuse, improper installation, or improper maintenance such as, but not limited to: heat from soldering during installation, the use of plumber's putty, damage from tools used during installation, the use or exposure to chemicals or cleaning products either abrasive or non-abrasive, or the use of any cleaning tool or product other than a soft, clean cloth. Reverse osmosis may also shorten the life of the finish.
2. Changes in the finish or in the product due to normal wear or aging does not cover any products or parts which have been altered or used in a manner not typical for the product.
3. Loss, damages, or expense, incidental or consequential whatsoever, originating from the purchase, installation, use, repair, failure, or replacement of any SANTEC product or part, allowed by law.
4. Commercial and/or Industrial installations and use of the product.
5. This warranty does not include labor, travel charges, or any costs incurred for repair, removal, installation, servicing, diagnosing, or handling of either defective or replacement parts.
6. Damage or deterioration caused by environmental impacts.

SANTEC reserves the product components of the covered product will be repaired, refinished, or replaced at the sole discretion of SANTEC. SANTEC reserves the right to examine any product claimed defective prior to any warranty claim being accepted or processed, at its sole discretion. This warranty gives you specific legal rights and you may have other rights which may vary from state to state.

The measurements shown are for reference only. Products and specifications shown are subject to change without notice.

www.santecfaucet.com | P: 310.542.0063 F: 310.542.5681