



Pressure Balanced Shower less shower head, arm and flange

PLEASE READ THE INSTRUCTIONS COMPLETELY
BEFORE BEGINNING THE INSTALLATION.

This is a general installation instruction
for the following collections:

- * Caprie
- * Heritage
- * Dome
- * Vantage

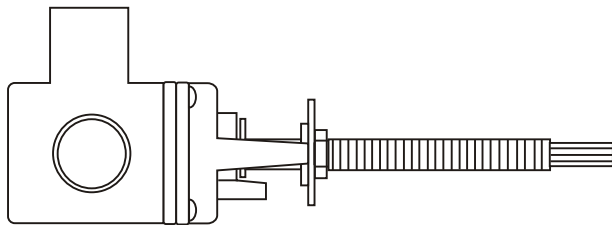
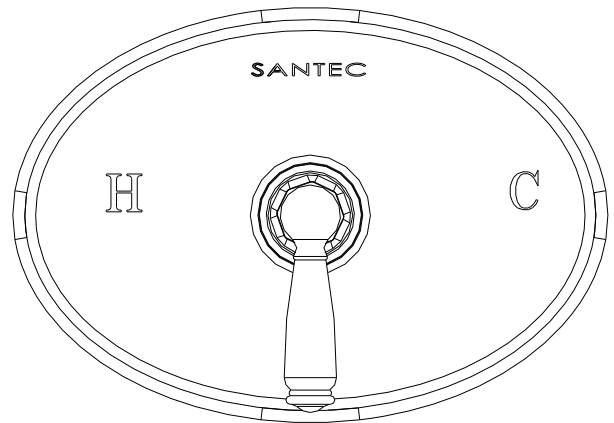
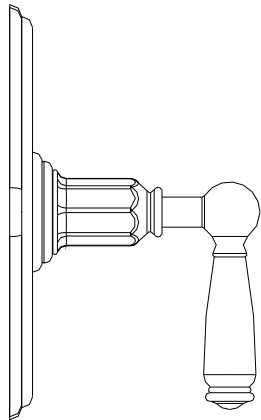

DESCRIPTION

This product is precision engineered to provide satisfactory performance provided it is installed and operated in accordance with our recommendations contained in this manual. In order to fully enjoy the comfort, safety and the reliability of your pressure balancing valve, be certain to familiarize yourself with the contents of this manual.

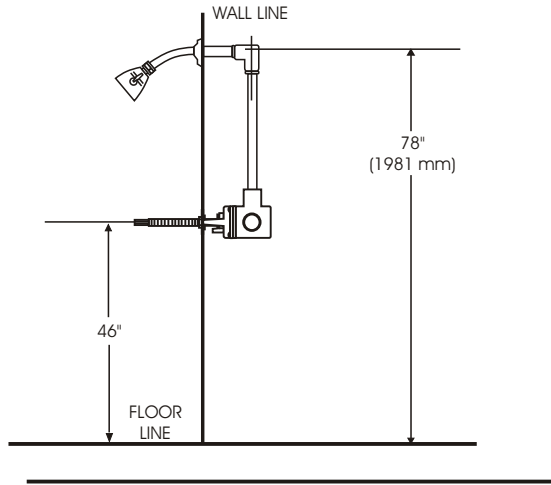

SPECIFICATIONS AND DIMENSIONS

Minimum operating pressure	20 psi
Maximum operating pressure	145 psi
Maximum test pressure	500 psi
Hot and cold water inlets	½" IPS
Shower outlet	½" IPS
Flow capacity	5 USGPM @ 50 psi
Finished wall adjustment	: see Illustration B

INSTALLATION

NOTE: Failure to follow these instructions may cause damage or improper operations and nullify the warranty.

ROUGH IN

- Make sure the water supplies are off.
- Remove all the trim items (plate, handle and flange) before installation.
- Secure the valve firmly against the stud. Make sure the ½" shower outlet is in the up position.
- Make sure to flush or raise grouting on the tiled wall surface.
- Adjust the All Thread depth against the Teflon Washer and Limit Stop.
Screw the All Thread against the Teflon washer until it is pressured gently against each other.
- Tighten firmly the Lock Nut against the Lock Plate.
- Position the valve using the dimension shown in the illustration B.

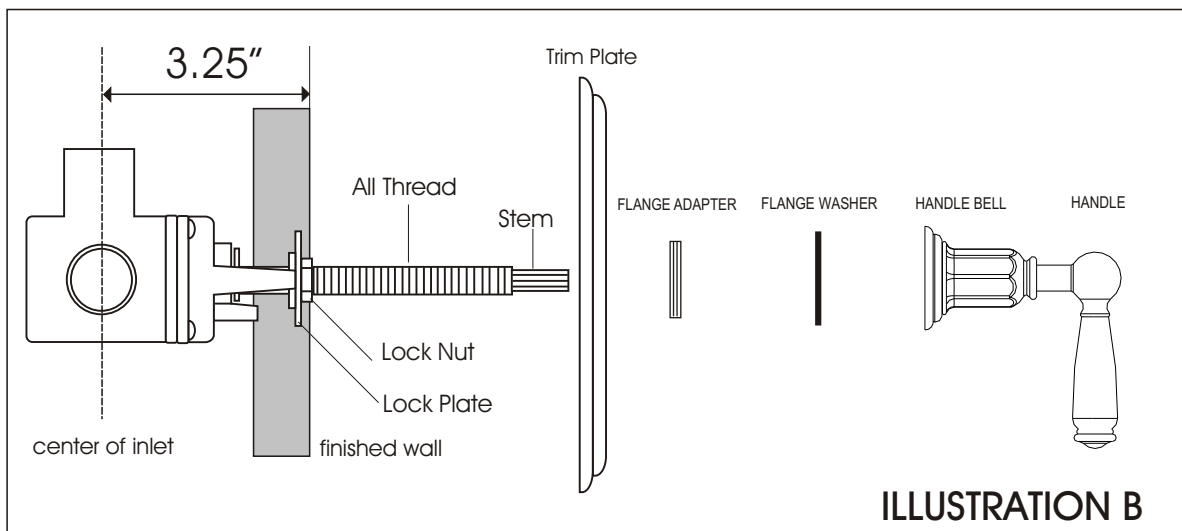

ILLUSTRATION B

TRIM INSTALLATION

- Place the shower plate on the all thread.
- Thread the handle set with the washer and adapter onto all thread with the stem and mark the position.
- Take off the handle assembly and cut off the excess thread and stem.
- Keeping the handle set at 6 o'clock position, thread handle assembly onto all thread by using escutcheon being caution not to over tighten.

FLANGE ADAPTER FLANGE WASHER HANDLE BELL HANDLE

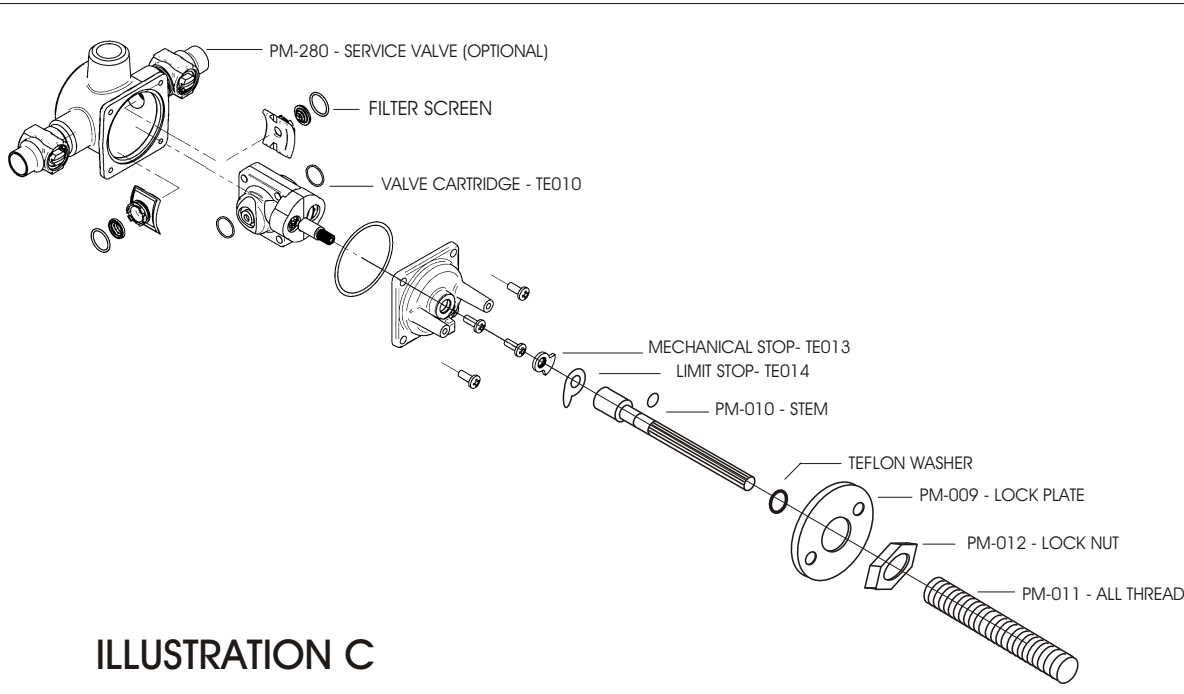
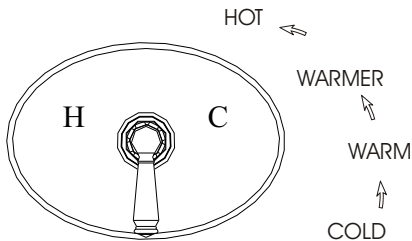
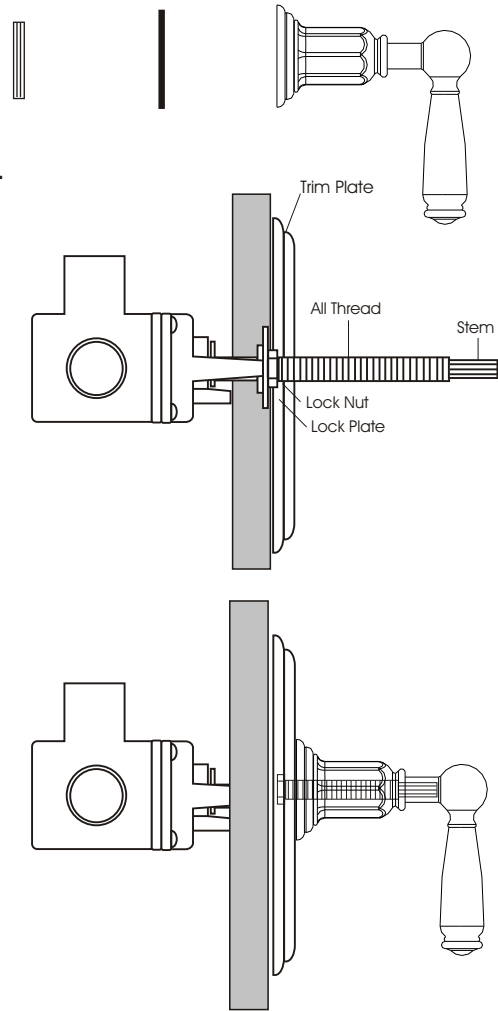

ILLUSTRATION C

INSTALLATION INSTRUCTIONS

Pressure Balanced Shower

TEMPERATURE LIMIT STOP SET UP

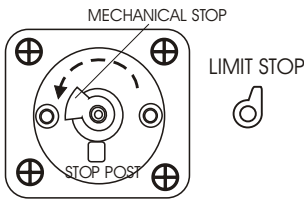

Illustration D1

- Santec Pressure Balanced Valve has a temperature limit stop (please see Illustration C) which once set properly can provide a safe and comfortable hot water.
Below is the limit stop installation procedure:

- Remove all Handle trim parts, including the trim plate.
- remove all internal parts up to the Limit Stop, do not remove the Mechanical Stop.

After Mechanical Stop is removed please follow the instruction bellow

- Turn the cartridge clockwise until it is stopped. Do not force to avoid damaging the cartridge.
- Insert the Mechanical Stop onto the cartridge
- Turn the cartridge counterclockwise to open the water line. Turn until it reaches the maximum hot water desired by the user.
- Place Limit Stop as shown in the Illustration D2.
- Reinstall all the parts accordingly to the Illustration C.

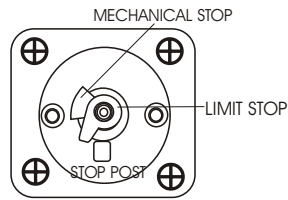
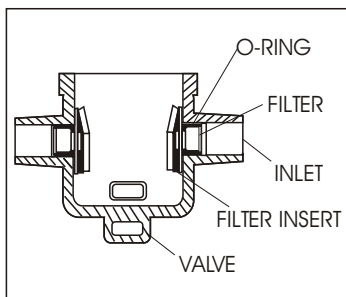

Illustration D2

TROUBLE SHOOTING

MALFUNCTION	CAUSE	REMEDY
Shower control opening through hot.	- Hot and cold water supplies have been connected in reverse	Rotate cartridge
Tub filler or Shower head drips after shutting off the valve.	- Water remains in the piping column to the shower head (this is normal). - Incorrect setting of the mechanical stop against the stop post causing a partially opened cartridge. - O-ring seal on the inlet of the cartridge is faulty.	- Allow approximately 3-5 minutes to drain column. - Reset the mechanical stop as described in this page - Check O-ring for cut or damage and replace if necessary.
Shower insufficiently hot.	- Adjustable handle position stop incorrectly set.	- Check hot water source temperature setting.
No flow of hot or cold water.	- Either the hot or cold side is not fully pressurized. - Debris caught inside the inlet of the cartridge.	- Be sure service stops (when applicable) are both wide open and system is fully pressurized. - Remove cartridge and flush out or remove any debris lodged inside the hot or cold inlet.
Valve body too deep into the wall.	- The measured rough in or finished wall surface is incorrect.	install the extension kit. PM460X(long sleeve). PM461X (long plastic upper link)

NOTE: AT NO TIME TRY TO STOP DRIPPING BY APPLYING EXTREME FORCE WHEN CLOSING THE VALVE.



FILTER SCREEN REMOVAL AND CLEANING

The valve has filter screens that prevent debris from obstructing the pressure balancing cartridge. If excessive in-line debris accumulates in the filter screen you will notice a decrease in flow from the valve. PLEASE NOTE - SHUT OFF BOTH HOT AND COLD WATER SUPPLIES BEFORE SERVICING VALVE.

- The filter screen are attached to an insert that is fitted into the valve body inlets.
- With the cartridge removed the 2 inserts and filter screens can be easily removed from the valve body.
- Remove the insert by pressing the top corner. This will rotate the insert allowing easy removal.
- There is a place on either side of the filter insert where you can get your finger nail underneath the filter screen. By pulling the filter screen away from the insert it will "pop out".
- All debris can be now be easily removed from the filter screen.
- Replace the filter screen into the insert and push together gently until it clicks into place.
- Place the insert back into the valve body, making sure the angled edge of the insert faces out.
- The insert should sit flush against the wall of the valve body when properly installed.