

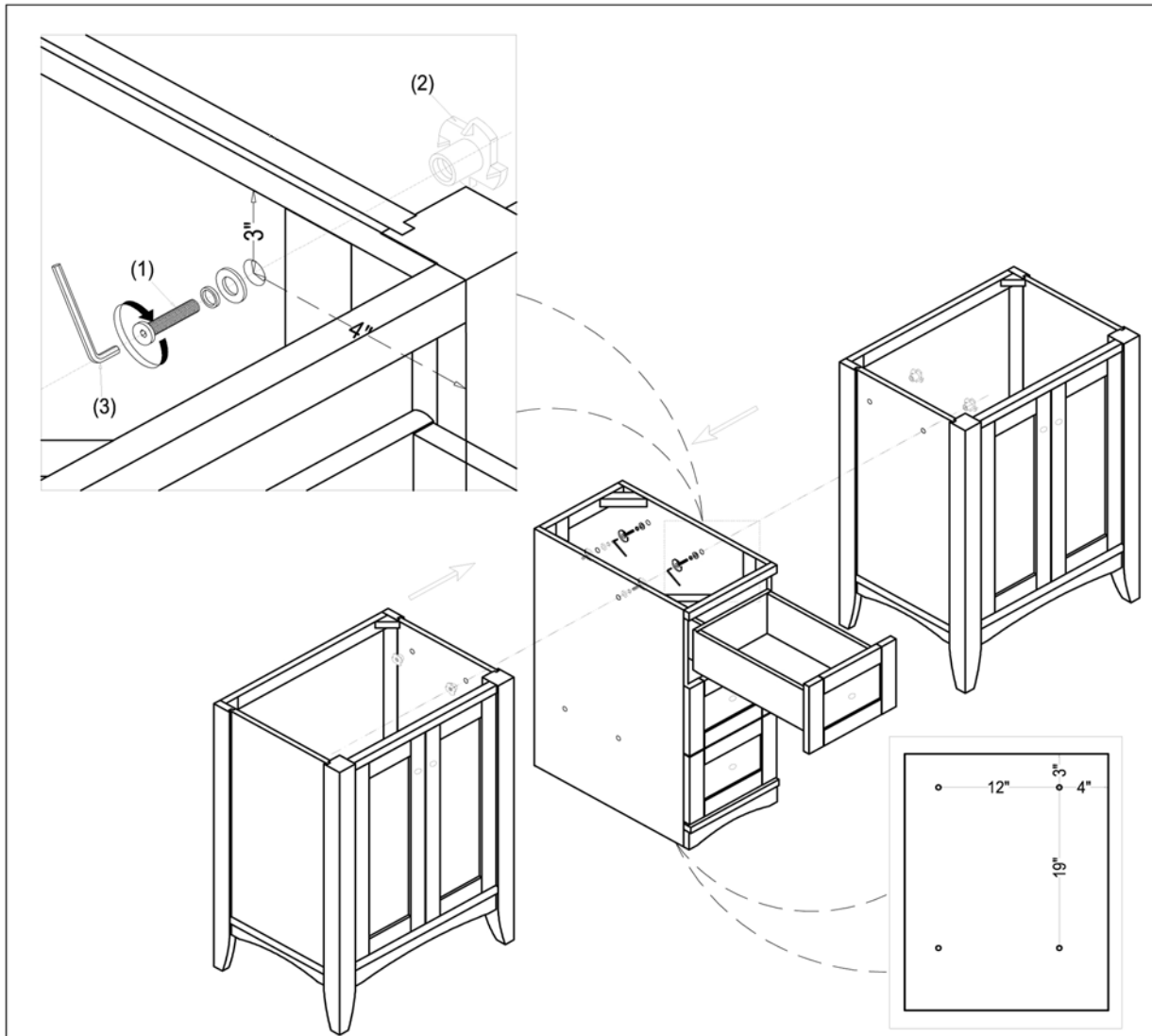





1513-DB12

12" DRAWER BRIDGE



| PARTS INCLUDED | | | | TOOLS AND MATERIALS | | |
|----------------|---|-------------|-------|--|---|---|
| 1 |  | Φ1/4 X 38mm | 8 PCS |  |  |  |
| 2 |  | Φ1/4 X 12mm | 8 PCS | | | |
| 3 |  | 4 X 75mm | 1 PC | | | |
| | | | | Electric drill | Tape measure | Pencil |

Fairmont Designs highly recommends that you seek a professional installation specialist if you are unsure of installation. Please note: Fairmont Designs is not responsible for any installation error, damages or injuries, actual or consequential resulting from possible printing error in instruction