

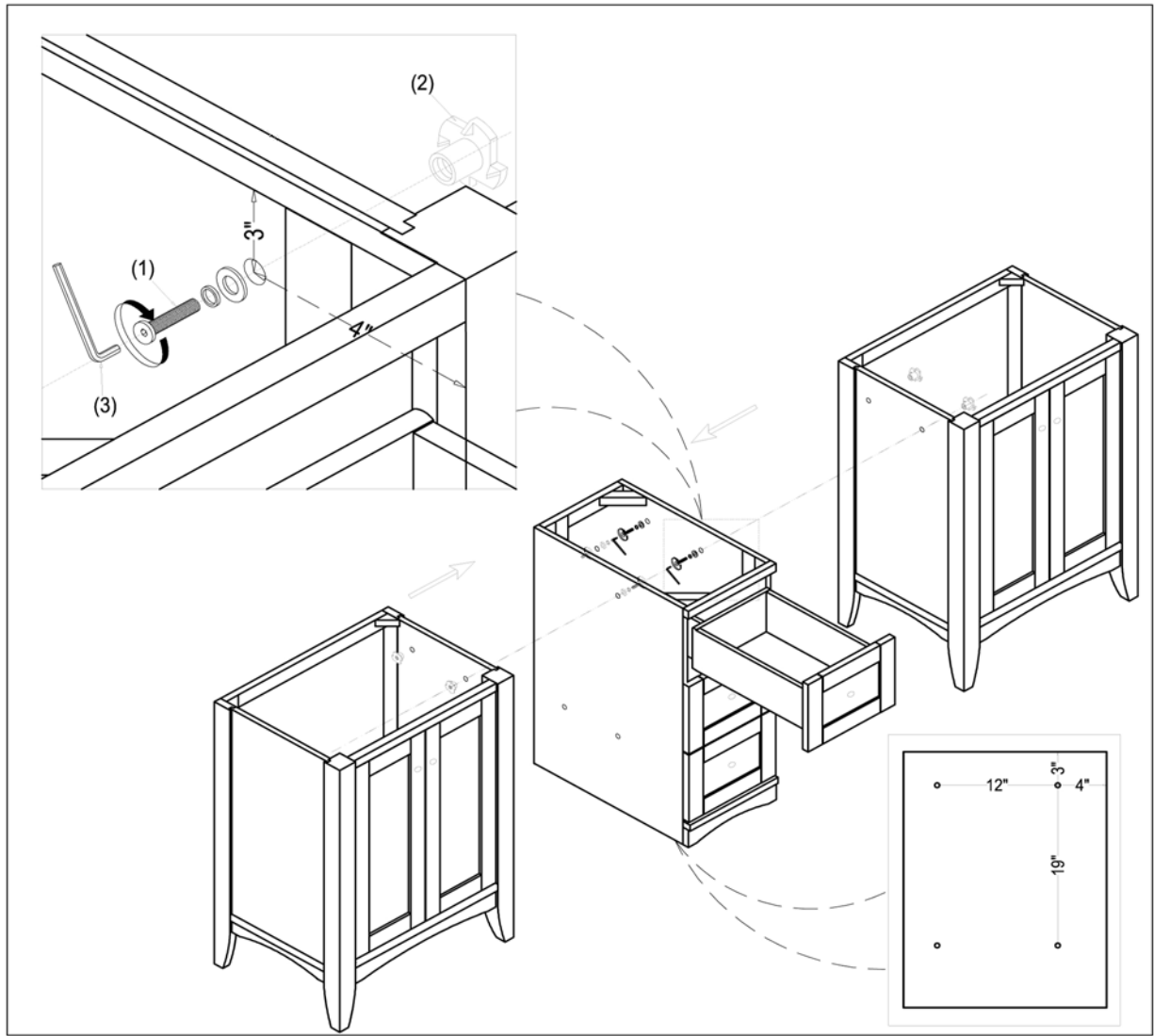





# 1512-DB12

## 12" DRAWER BRIDGE



PARTS INCLUDED				TOOLS AND MATERIALS		
1		Φ1/4 X 38mm	8 PCS			
2		Φ1/4 X 12mm	8 PCS			
3		4 X 75mm	1 PC			
				Electric drill	Tape measure	Pencil

Fairmont Designs highly recommends that you seek a professional installation specialist if you are unsure of installation. Please note: Fairmont Designs is not responsible for any installation error, damages or injuries, actual or consequential resulting from possible printing error in instruction