

# L-Cube

# # LC 6859

## Montageanleitung

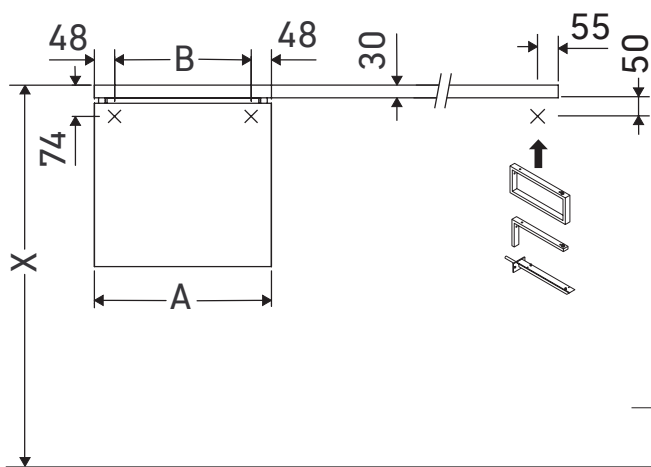

Bohrmaße beachten!



Alle weiteren Montageanleitungen beachten!

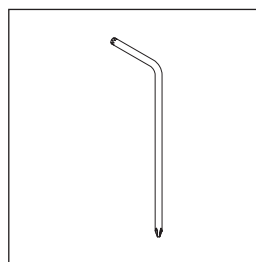
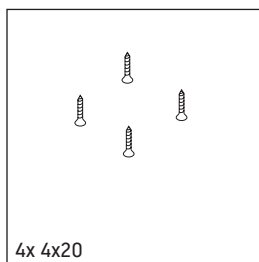
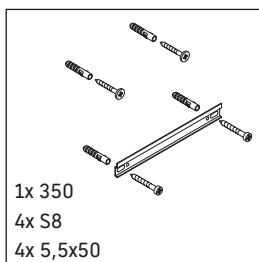
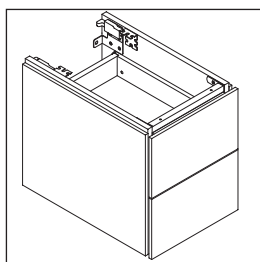

## Verwendungshinweise

Die Badmöbelserie entspricht den gültigen Normen und Richtlinien zum Zeitpunkt der Auslieferung und ist für den Einsatz in Bädern konzipiert.

Eine direkte Benetzung mit Wasser z. B. beim Duschen ist zu vermeiden.

Keramiken breiter als 600 mm müssen an der Wand befestigt werden.

Technische Verbesserungen und optische Veränderungen an den abgebildeten Produkten behalten wir uns vor.

