

# DuraStyle

# # DS 9893

## Installation instructions

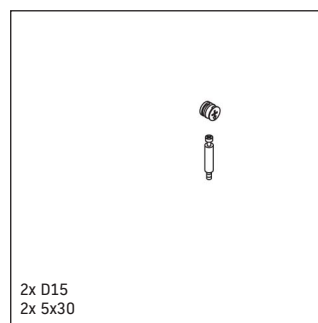
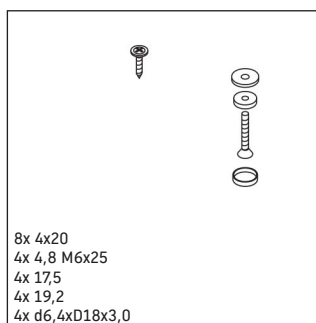
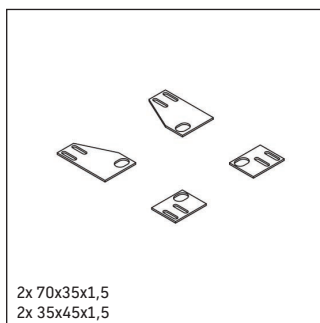
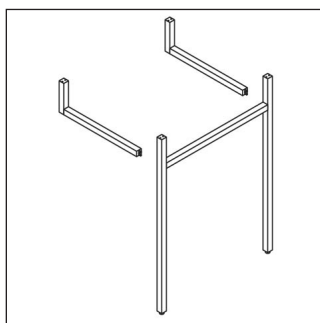

### Instructions for use

The bathroom furniture range complies with the standards and guidelines applicable at the time of delivery and is designed for use in bathrooms. Though designed for the wet environment, direct contact with water should be avoided, for example, when showering. We reserve the right to make technical improvements and design modifications to the products illustrated.

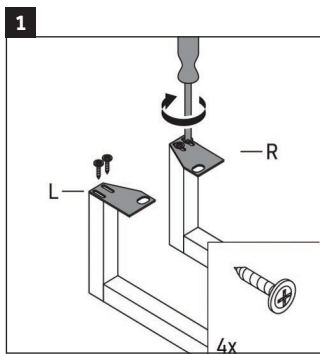

Using screw driver, screw four screws counter-clockwise. Connect left and right mounting with left and right tower rails.

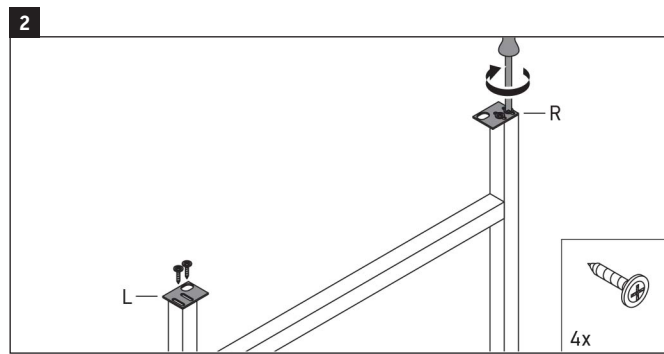

Using screw driver, screw four screws counter-clockwise. Connect smaller left and right plates with the left and right console legs.

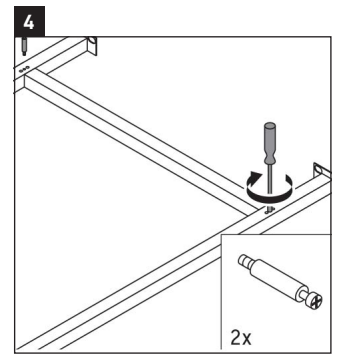

Using screw driver, screw two screws counter-clockwise.

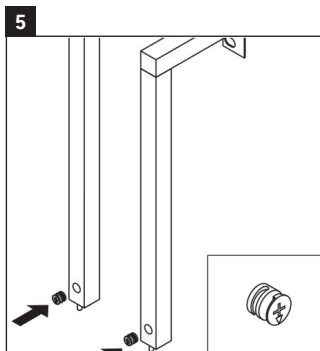

Add two screws.

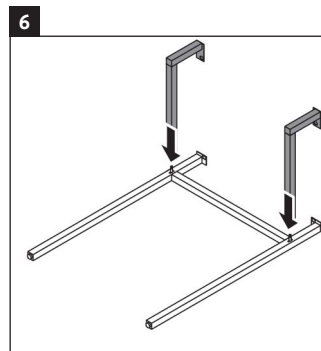

Connect towel rails to the console legs.

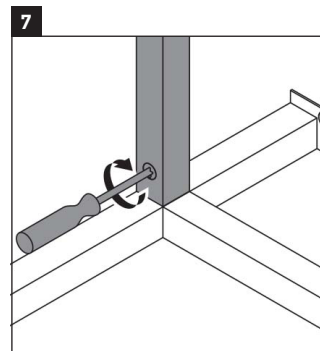

Using screw driver tighten the towel rails.

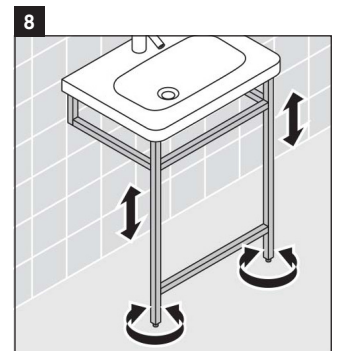

The height of the console can be adjusted by turning the bottom screws either clockwise or counter-clockwise.

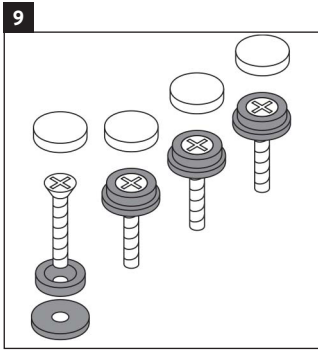

Check that four screws, eight washers and four caps are included.

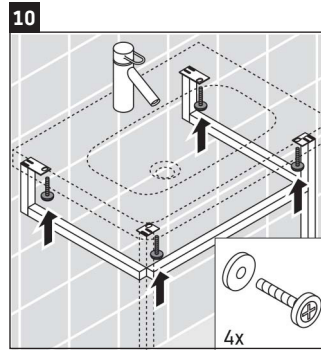

Connect the console to the washbasin using screws and washers.

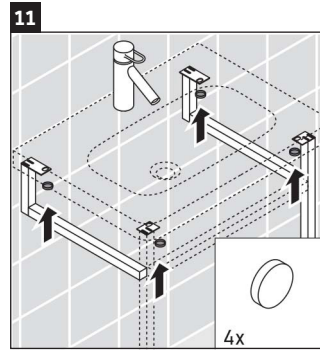

Attach four caps to the console.



Installation is complete.

---

Furniture complies with applicable requirements of the referenced standard(s):  
Safety Household and Commercial Furnishings (UL 962, 3rd ed. Issued: 07/07/08, Revised: 08/05/13)  
Portable Luminaires CSA C22.2 No. 12 - 1982 (R2004)

## IMPORTANT SAFETY INSTRUCTIONS

When using an electrical furnishing, basic precautions should always be followed, including the following:

Read all instructions before using this furnishing.

**DANGER** To reduce the risk of electric shock:

1. Always power down all circuits before cleaning.

**WARNING** To reduce the risk of burns, fire, electric shock, or injury to persons:

1. Disconnect from power before putting on or taking off parts. A minimum of two people is required to remove and replace cabinet doors.
2. Close supervision is necessary when this furnishing is used by, or near children, invalids, or disabled persons.
3. Use this furnishing only for its intended use as described in these instructions. Do not use attachments not recommended by the manufacture.
4. Never operate this furnishing if it has a damaged cord or plug, if it is not working properly, if it has been dropped or damaged, or dropped into water. Return the furnishing to a service center for examination and repair.
5. Never drop or insert any object into any opening.
6. Do not use outdoors.
7. Do not operate where aerosol (spray) products are being used or where oxygen is being administered.
8. For loading always put heavier items at the bottom and not near the top in order to help prevent the possibility of the furnishing tipping over.  
MAXIMUM SHELF LOAD IN POUNDS ALLOWED: 6.61 lbs
9. To disconnect, power down all circuits.
10. Risk of Injury to Persons - do not place video equipment such as televisions or computer monitors on furnishing.

## GROUNDING INSTRUCTIONS

This product must be connected to a grounded metal, permanent wiring system, or an equipment - grounding conductor must be run with the circuit conductors and connected to the equipment grounding terminal or lead on the product.

## ABOUT THE PRODUCT

Products requiring electricity are designed to be switched at the wall and hardwired to a circuit provided by the customer. Product should be installed according to electrical code by a qualified technician. Read important safety instructions carefully. Direct wetting should be avoided. This products is intended for household/residential use only. We reserve the right to make technical improvements and to enhance the appearance of the products shown.

## SAVE THESE INSTRUCTIONS

**Duravit NYC**

105 Madison Avenue  
New York, NY 10016  
Toll Free 888-DURAVIT  
Phone 212-686-0033  
Fax 212-686-8033  
info@us.duravit.com  
www.duravit.nyc

**Duravit USA, Inc.**

2205 Northmont Pkwy., Ste. 200  
Duluth, GA 30096  
Toll Free 888-DURAVIT  
Phone 770-931-3575  
Fax 770-931-8454  
info@us.duravit.com  
www.duravit.us

---

