

Starck

ST 8941

Montageanleitung

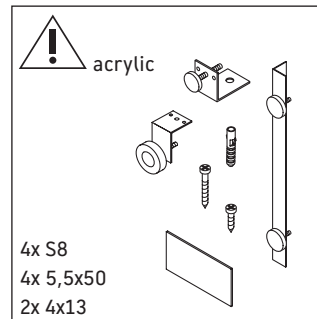
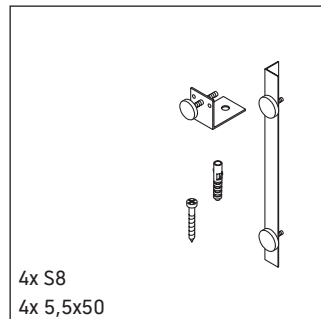
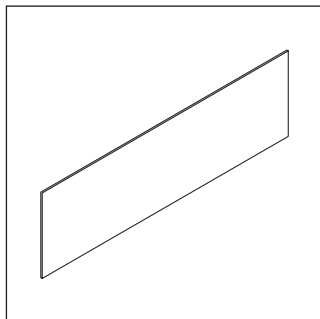

Starck # 700340



Alle weiteren Montageanleitungen beachten!

Verwendungshinweise

Technische Verbesserungen und optische Veränderungen an den abgebildeten Produkten behalten wir uns vor.

