

PRODUCT SPECIFICATIONS

Elkay CuVerro Antimicrobial Copper 19-1/2" x 22" x 5-1/2", Single Bowl Top Mount Sink. Sink is formed from 18 gauge CuVerro[®] Antimicrobial Copper that combines beauty and performance to be the only touch surface material registered by the U.S. Environmental Protection Agency (EPA) to continuously kill more than 99.9% of bacteria within two hours. Sink has Rear Center drain placement, and Full spray sides and bottom.

Installation Type:	Top Mount
Material:	CuVerro Antimicrobial Copper
Finish:	Lustrous Highlighted Satin
Gauge:	18
Sound Deadening:	Full spray sides and bottom
Number of Bowls:	1
Sink Dimensions:	19-1/2" x 22" x 5-1/2"
Bowl 1 Dimensions:	16" x 16" x 3-7/8"
Drain Size:	3-1/2" (89mm)
Drain Location:	Rear Center
Minimum Cabinet Size:	24"
Mounting Hardware:	Part # 64090012 included for countertops up to 3/4" (19mm) thick
Cutout Template #:	1000001263

Template is available for download at elkay.com

Cutout Dimensions for Top Mount Installation:

18-7/8" x 21-3/8" (479mm x 543mm) with 1-1/2" (38mm) corner radius



This sink is compliant to ADA and ANSI/ICC A117.1 accessibility requirements when installed according to the requirements outlined in these standards.

Hole Drilling Configurations:

1-1/2" (38mm) Diameter Faucet Holes on 4" (102mm) Centers

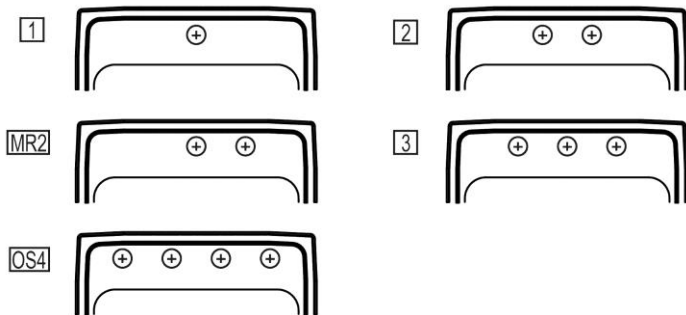

AMERICAN PRIDE. A LIFETIME TRADITION.

Like your family, the Elkay family has values and traditions that endure. For almost a century, Elkay has been a family-owned and operated company, providing thousands of jobs that support our families and communities.



Sinks are listed by IAPMO[®] as meeting the applicable requirements of the Uniform Plumbing Code[®], International Plumbing Code[®], and National Plumbing Code of Canada.

Product Compliance: ADA & ICC A117.1
BUY AMERICAN ACT
CSA B45.12/IAPMO Z402

- [Clean and Care Manual \(PDF\)](#)
- [Clean and Care Manual \(PDF\)](#)
- [Installation Instructions \(PDF\)](#)
- [Limited Lifetime Warranty \(PDF\)](#)

Similar models are available with: additional ADA depths

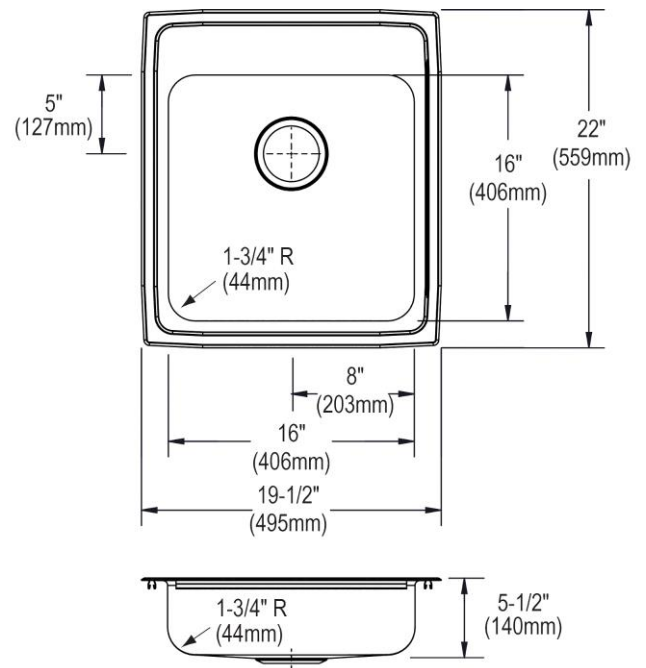

PART: _____ QTY: _____

PROJECT: _____

CONTACT: _____

DATE: _____

NOTES: _____

APPROVAL: _____

In keeping with our policy of continuing product improvement, Elkay reserves the right to change product specifications without notice. Please visit elkay.com for the most current version of Elkay product specification sheets. This specification describes an Elkay product with design, quality, and functional benefits to the user. When making a comparison of other producers' offerings, be certain these features are not overlooked.

Installation Profile:



OPTIONAL ACCESSORIES

Drain:	LKVR18-CU
Hardware:	LK364, LK463

In keeping with our policy of continuing product improvement, Elkay reserves the right to change product specifications without notice. Please visit elkay.com for the most current version of Elkay product specification sheets. This specification describes an Elkay product with design, quality, and functional benefits to the user. When making a comparison of other producers' offerings, be certain these features are not overlooked.