

**PRODUCT SPECIFICATIONS**

Elkay Lustertone Stainless Steel 23-1/2" x 18-1/4" x 4-7/8", Single Bowl Undermount Sink. Sink is manufactured from 18 gauge 304 Stainless Steel with a Lustrous Highlighted Satin finish, Rear Center drain placement, and Full spray sides and bottom.

<b>Installation Type:</b>	Undermount
<b>Material:</b>	304 Stainless Steel
<b>Finish:</b>	Lustrous Highlighted Satin
<b>Gauge:</b>	18
<b>Sound Deadening:</b>	Full spray sides and bottom
<b>Number of Bowls:</b>	1
<b>Sink Dimensions:</b>	23-1/2" x 18-1/4" x 4-7/8"
<b>Bowl 1 Dimensions:</b>	21" x 15-3/4" x 4-7/8"
<b>Drain Size:</b>	3-1/2" (89mm)
<b>Drain Location:</b>	Rear Center
<b>Minimum Cabinet Size:</b>	27"
<b>Mounting Hardware:</b>	Undermount brackets sold separately
<b>Template Included:</b>	Yes
<b>Cutout Template #:</b>	<a href="#">1000001400</a>

Template is available for download at [elkay.com](#)

 This sink is compliant to ADA and ANSI/ICC A117.1 accessibility requirements when installed according to the requirements outlined in these standards.

**Installation Profile:**

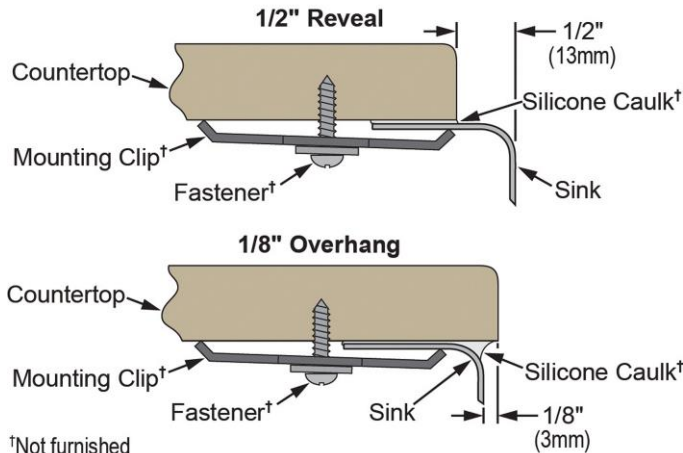

†Not furnished  
Designed to affix to the underside of any solid surface countertop.



AMERICAN PRIDE. A LIFETIME TRADITION.  
Like your family, the Elkay family has values and traditions that endure. For almost a century, Elkay has been a family-owned and operated company, providing thousands of jobs that support our families and communities.



 Sinks are listed by IAPMO<sup>®</sup> as meeting the applicable requirements of the Uniform Plumbing Code<sup>®</sup>, International Plumbing Code<sup>®</sup>, and National Plumbing Code of Canada.

**Product Compliance:** ADA & ICC A117.1  
ASME A112.19.3/CSA B45.4  
BUY AMERICAN ACT

[Clean and Care Manual \(PDF\)](#)  
[Installation Instructions \(PDF\)](#)  
[Limited Lifetime Warranty \(PDF\)](#)

**Similar models are available with:** additional ADA depths, Perfect Drain

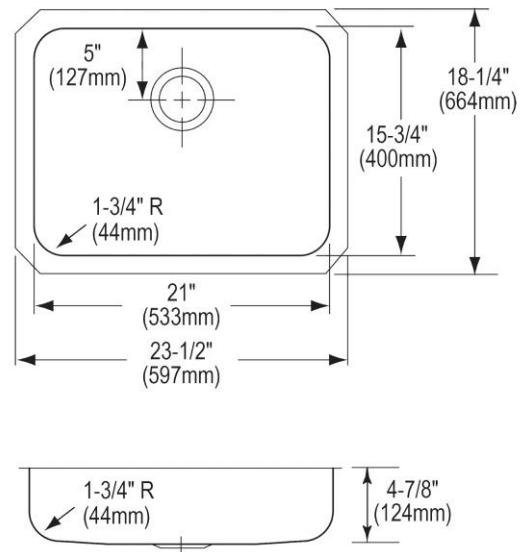

PART: \_\_\_\_\_ QTY: \_\_\_\_\_  
PROJECT: \_\_\_\_\_  
CONTACT: \_\_\_\_\_  
DATE: \_\_\_\_\_  
NOTES: \_\_\_\_\_  
APPROVAL: \_\_\_\_\_

In keeping with our policy of continuing product improvement, Elkay reserves the right to change product specifications without notice. Please visit [elkay.com](#) for the most current version of Elkay product specification sheets. This specification describes an Elkay product with design, quality, and functional benefits to the user. When making a comparison of other producers' offerings, be certain these features are not overlooked.

**OPTIONAL ACCESSORIES**

<b>Bottom Grid:</b>	LKWOBG2115SS
<b>Drain:</b>	LK99, LKAD35
<b>Faucet:</b>	LKGT1041, LKGT2041
<b>Hardware:</b>	LKUCLIP8
<b>Rinsing Basket:</b>	LKWRB2115SS, LKWERBSS
<b>Sinkmate:</b>	LKSM17, LKSMHOOK, LKSMSPONGE, LKSMHSL
<b>Soap Dispenser:</b>	LKGT1054

*In keeping with our policy of continuing product improvement, Elkay reserves the right to change product specifications without notice. Please visit [elkay.com](http://elkay.com) for the most current version of Elkay product specification sheets. This specification describes an Elkay product with design, quality, and functional benefits to the user. When making a comparison of other producers' offerings, be certain these features are not overlooked.*