

Vero

VE 1126 L/R

Montageanleitung

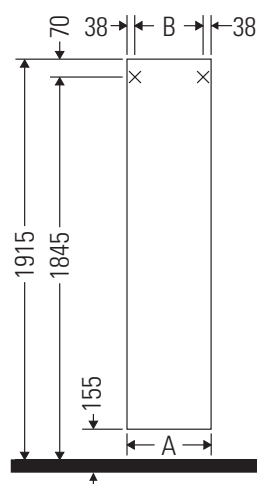

A	B
mm	mm
400	324

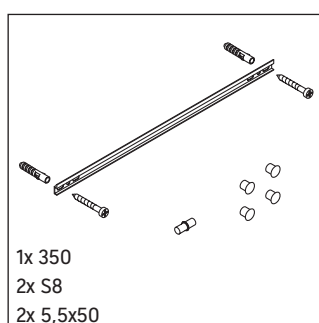
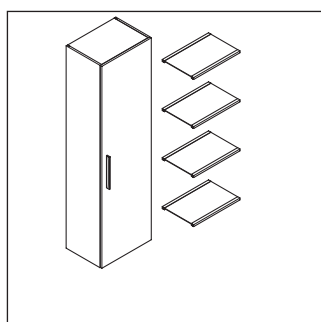

Achtung! Bruchgefahr! Spiegeltüren nicht auf einer Ecke absetzen.

Verwendungshinweise

Die Badmöbelserie entspricht den gültigen Normen und Richtlinien zum Zeitpunkt der Auslieferung und ist für den Einsatz in Bädern konzipiert. Eine direkte Benetzung mit Wasser z. B. beim Duschen ist zu vermeiden.

Technische Verbesserungen und optische Veränderungen an den abgebildeten Produkten behalten wir uns vor.

