

Ketho

KT 7330

Installation instructions

A mm	A inch	B mm	B inch
650	25 5/8"	500	19 5/8"

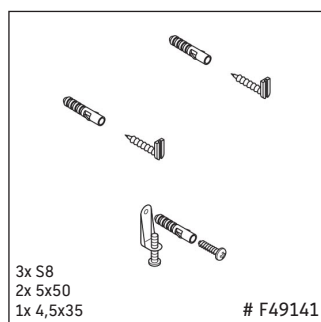
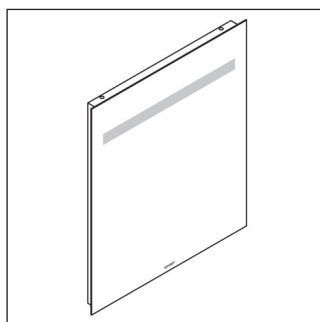
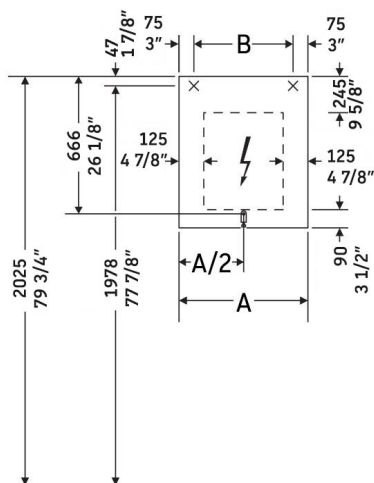

Instructions for use

The bathroom furniture range complies with the standards and guidelines applicable at the time of delivery and is designed for use in bathrooms.

Though designed for the wet environment, direct contact with water should be avoided, for example, when showering.

Mirrors require a GFCI 110 V 60 Hz power source. Flat plug will be supplied with mirror.

Distance between sensor and reflecting surfaces => 3" (75 mm).

We reserve the right to make technical improvements and design modifications to the products illustrated.

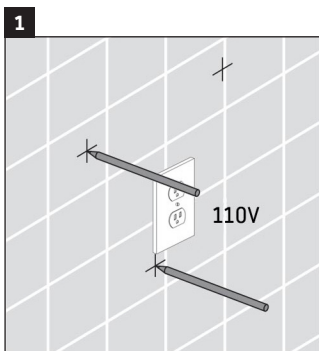

A 110 V GFCI outlet is required. Mark the holes to be drilled for the anchors.

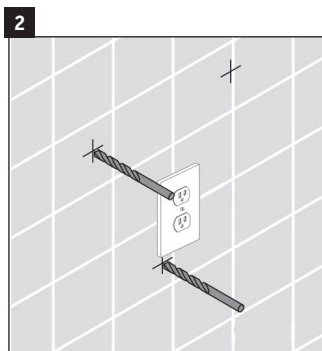

Using a 3/8" and 5/8" drill bit, drill the anchor holes that have been marked.

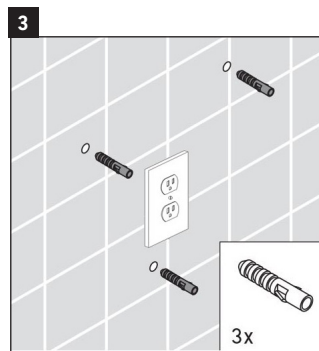

The plastic anchors provided are for concrete wall applications.

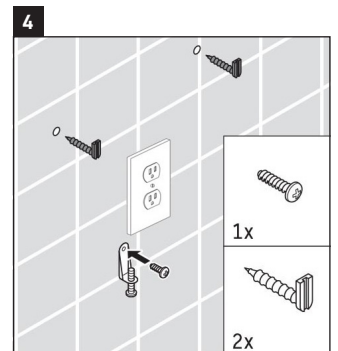

Thread the two mounting screws into top two anchors, leaving hooks facing up. Secure the L-bracket to wall with set screw on the bottom.

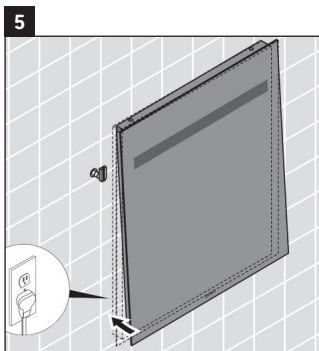

Plug the mirror into the outlet and line up the mounting hooks with the inserts on the back of the mirror. Push mirror onto wall until hooks are inserted securely.

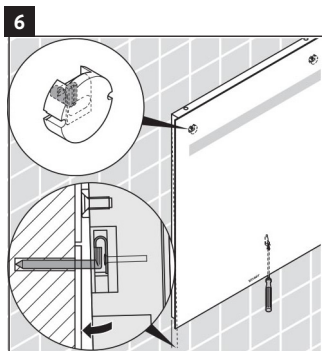

Lay the bottom of the mirror against the wall and tighten the set screw to secure the mirror in place.

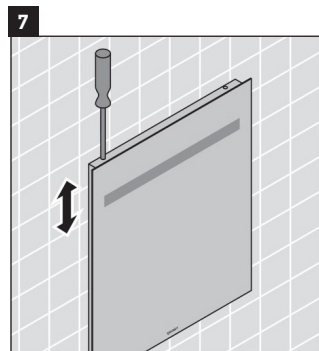

Use adjustment tool to move mirror up and down for leveling.

Furniture complies with applicable requirements of the referenced standard(s):
Safety Household and Commercial Furnishings (UL 962, 3rd ed. Issued: 07/07/08, Revised: 08/05/13)
Portable Luminaires CSA C22.2 No. 12 - 1982 (R2004)

IMPORTANT SAFETY INSTRUCTIONS

When using an electrical furnishing, basic precautions should always be followed, including the following:
Read all instructions before using this furnishing.

DANGER To reduce the risk of electric shock:

1. Always power down all circuits and disconnect before cleaning.
2. To reduce the risk of electric shock, this furnishing has a polarized plug (one blade is wider than the other). This plug will fit in a polarized outlet only one way. If the plug does not fit fully in the outlet, reserve the plug. If it still does not fit, contact a qualified electrician to install the proper outlet. Do not change the plug in any way.

CAUTION:

To prevent electric shock, match wide blade of plug to wide slot, fully insert.

WARNING To reduce the risk of burns, fire, electric shock, or injury to persons:

1. Disconnect from power before putting on or taking off parts. A minimum of two people is required to remove and replace cabinet doors.
2. Close supervision is necessary when this furnishing is used by, or near children, invalids, or disabled persons.
3. Use this furnishing only for its intended use as described in these instructions. Do not use attachments not recommended by the manufacture.
4. Never operate this furnishing if it has a damaged cord or plug, if it is not working properly, if it has been dropped or damaged, or dropped into water. Return the furnishing to a service center for examination and repair.
5. Never drop or insert any object into any opening.
6. Do not use outdoors.
7. Do not operate where aerosol (spray) products are being used or where oxygen is being administered.
8. For loading always put heavier items at the bottom and not near the top in order to help prevent the possibility of the furnishing tipping over.
MAXIMUM SHELF LOAD IN POUNDS ALLOWED: 6.61 lbs
9. To disconnect, power down all circuits.
10. Risk of Injury to Persons - do not place video equipment such as televisions or computer monitors on furnishing.
11. For grounded products the following statement:
WARNING: Risk of Electric Shock - Connect this furnishing to a properly grounded outlet only.

GROUNDING INSTRUCTIONS

This product must be connected to a grounded metal, permanent wiring system, or an equipment - grounding conductor must be run with the circuit conductors and connected to the equipment grounding terminal or lead on the product. (If provided with a 3 wire system)

ABOUT THE PRODUCT

Products requiring electricity are designed to be switched at the wall and hardwired to a circuit provided by the customer. Product should be installed according to electrical code by a qualified technician. Read important safety instructions carefully. Direct wetting should be avoided. This products is intended for household/residential use only. We reserve the right to make technical improvements and to enhance the appearance of the products shown.

SAVE THESE INSTRUCTIONS

Duravit NYC

105 Madison Avenue
New York, NY 10016
Toll Free 888-DURAVIT
Phone 212-686-0033
Fax 212-686-8033
info@us.duravit.com
www.duravit.nyc

Duravit USA, Inc.

2635 North Berkeley Lake Rd., Ste. 100
Duluth, GA 30096
Toll Free 888-DURAVIT
Phone 770-931-3575
Fax 770-931-8454
info@us.duravit.com
www.duravit.us

