

PRODUCT SPECIFICATIONS

Food Service Wall Mount Faucet. Faucet has a flow rate of 1.5 GPM, and is made of Chrome Plated Brass material, with a Quarter Turn Ceramic Disc valve. Faucet requires 2 faucet holes.

Mounting Type:	Wall Mount
Special Features:	Low Flow Solid Brass Construction Spout swing restriction pin
Spray Type:	Pre Rinse
Finish:	Chrome
Handle Type:	Lever Handle
Spout Reach:	30"
Spout Height:	41-1/8"
Hole Drillings:	2
Material:	Chrome Plated Brass
Valve Type:	Quarter Turn Ceramic Disc
Valve Connection:	1/2"-14 NPT
Flow Rate:	1.5 GPM
Faucet Hole Spread:	8"
Spout Swing Rotation:	360°
Spout Type:	Flexible Spout

Special Note: 1.6 GPM spray head



AMERICAN PRIDE. A LIFETIME TRADITION.
Like your family, the Elkay family has values and traditions that endure. For almost a century, Elkay has been a family-owned and operated company, providing thousands of jobs that support our families and communities.



Product Compliance: ASME A112.18.1/CSA B125.1
NSF 372 (lead free)
NSF 61

[Clean and Care Manual \(PDF\)](#)
[Installation Instructions \(PDF\)](#)
[Limited Warranty \(PDF\)](#)

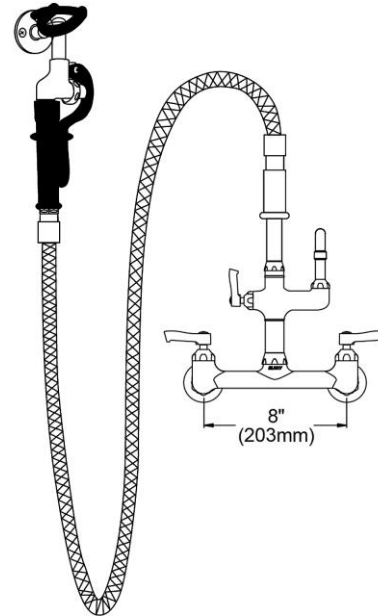

PART: _____ QTY: _____

PROJECT: _____

CONTACT: _____

DATE: _____

NOTES: _____

APPROVAL: _____

In keeping with our policy of continuing product improvement, Elkay reserves the right to change product specifications without notice. Please visit elkay.com for the most current version of Elkay product specification sheets. This specification describes an Elkay product with design, quality, and functional benefits to the user. When making a comparison of other producers' offerings, be certain these features are not overlooked.

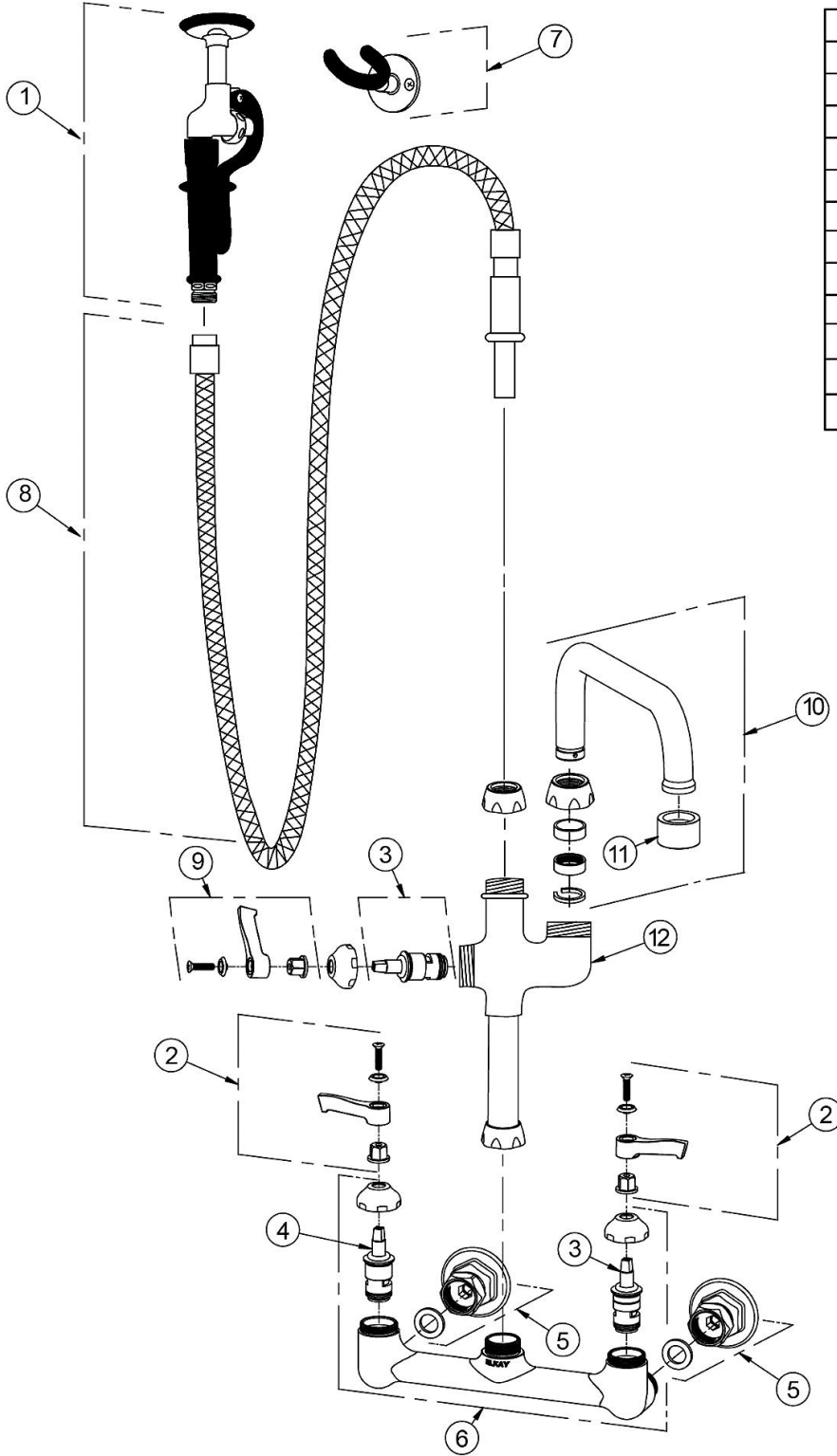

ITEM	IND. PART	DESCRIPTION
1	45942C	3.2 GPM Spray Valve
2	45918C	Handle, 2"
3	45923C	Right Cold Cartridge
4	45924C	Left Hot Cartridge
5	A55414	1/2" Offset Shutoff
6	45912C	Body
7	45936C	Wall Mount
8	45935C	60" Hose
9	A55385	Handle, 2"
10	A55399	Spout, 12"
11	LK734	2.2 GPM VR Aerator
12	45934C	Add On Faucet Body

In keeping with our policy of continuing product improvement, Elkay reserves the right to change product specifications without notice. Please visit elkay.com for the most current version of Elkay product specification sheets. This specification describes an Elkay product with design, quality, and functional benefits to the user. When making a comparison of other producers' offerings, be certain these features are not overlooked.