

48"

Item Number:

850-V48-AWT
850-V48-SOK

JAMES MARTIN

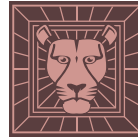

VANITIES™

Metropolitan 48" Cabinet

Diagrams with Dimensions
page 01 of 03

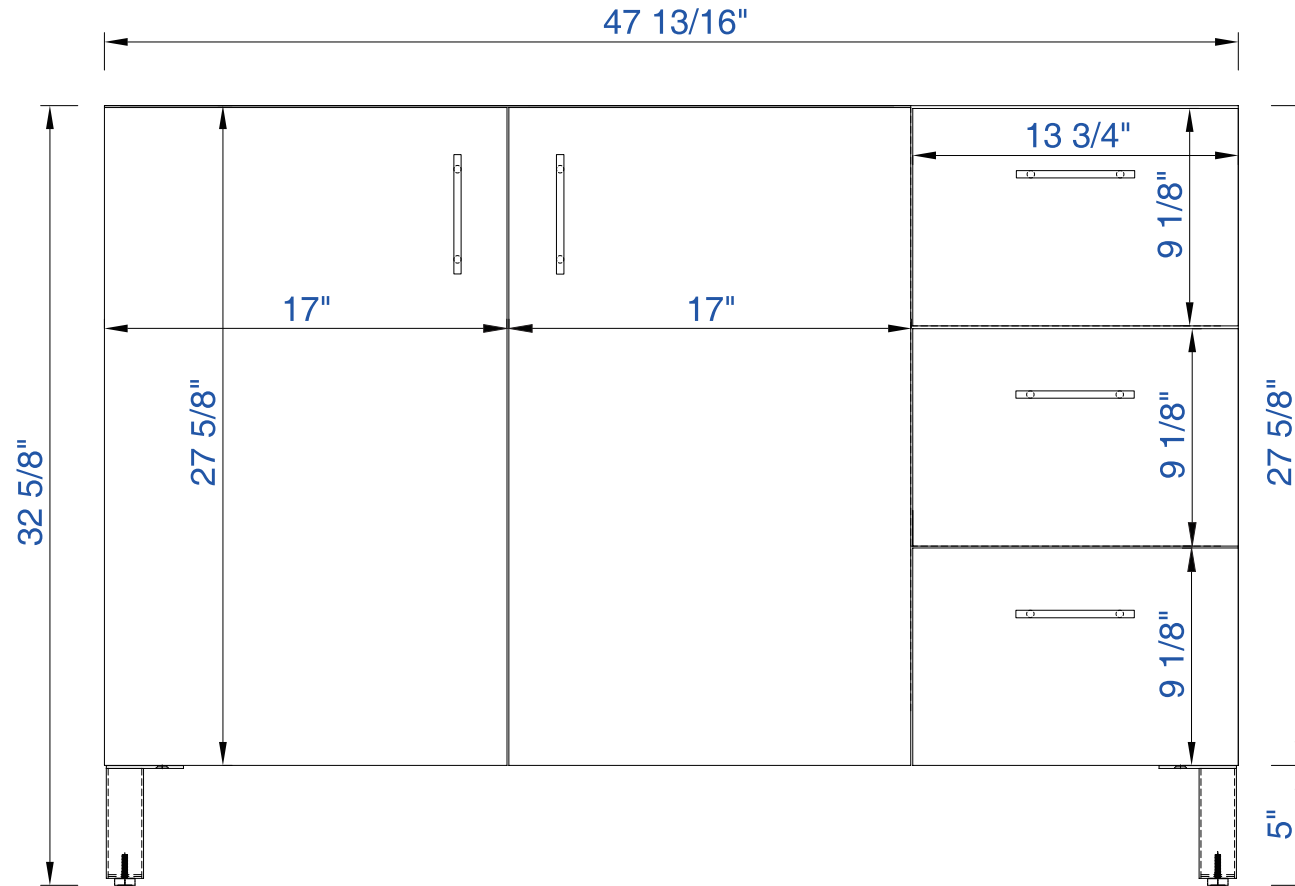

NOTE ONE: Countertops are not shown in these diagrams. (Cabinet Only)

NOTE TWO: This vanity does not have a Backsplash.

Please consult our website for Countertop Diagrams: www.jamesmartinvanities.com

48"

Item Number:

850-V48-AWT
850-V48-SOK

JAMES MARTIN



VANITIES™

Metropolitan 48" Cabinet

Diagrams with Dimensions
page 02 of 03

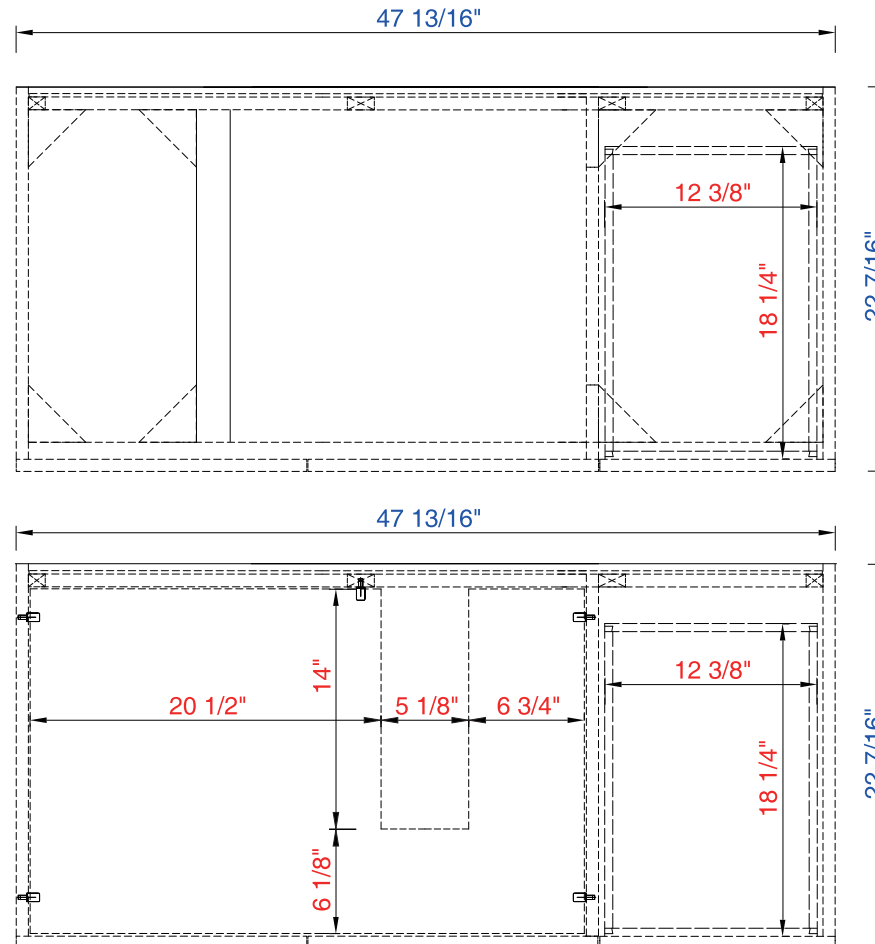

NOTE ONE: Countertops are not shown in these diagrams. (Cabinet Only)

NOTE TWO: Internal Shelves (Shown) are designed to align with sinks in James Martin's Optional Countertops. Customers' own countertops and sinks may align differently, and modification may be required. Please consult our website for Countertop Diagrams: www.jamesmartinvanities.com

48"

Item Number:

850-V48-AWT
850-V48-SOK

JAMES MARTIN

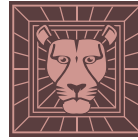

VANITIES™

Metropolitan 48" Cabinet

Diagrams with Dimensions
page 03 of 03

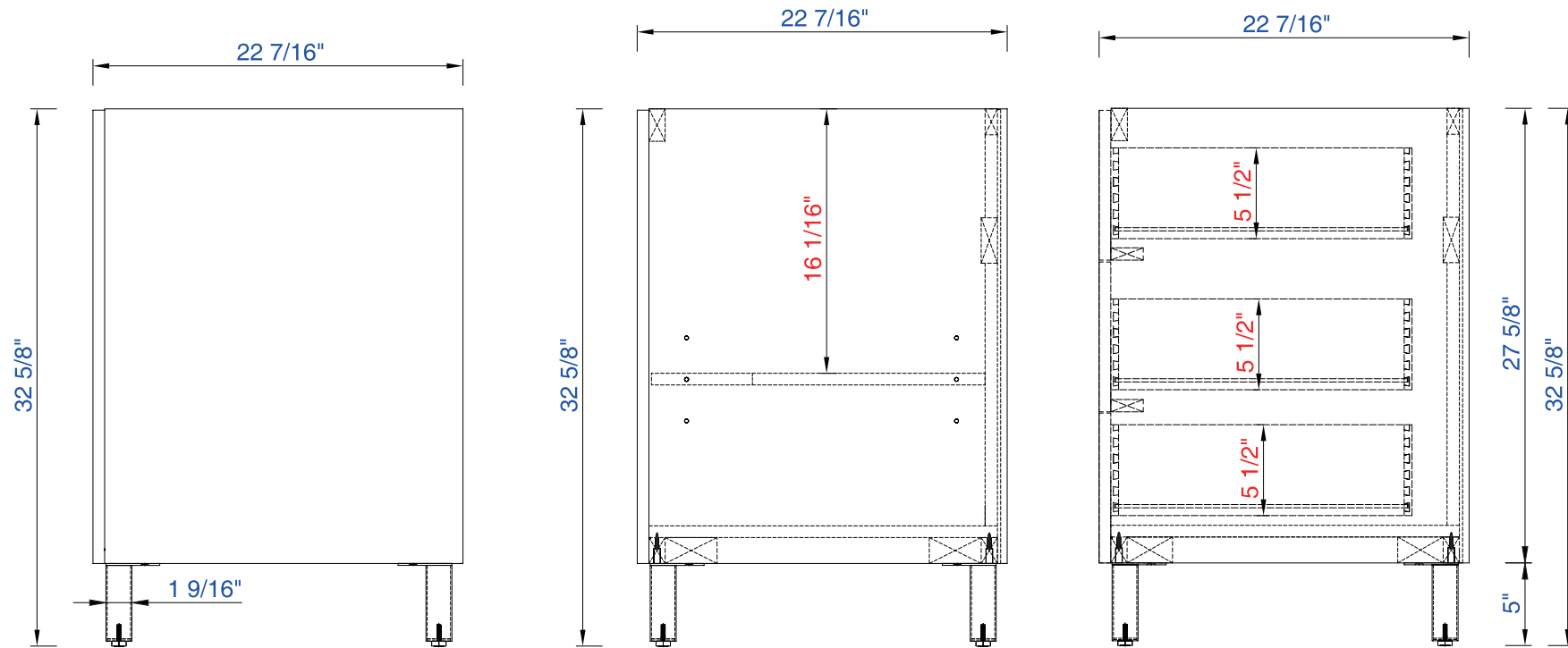

NOTE ONE: Countertops are not shown in these diagrams. (Cabinet Only)

NOTE TWO: This vanity does not have a Backsplash.

Please consult our website for Countertop Diagrams: www.jamesmartinvanities.com

1219mm

Item Number:

850-V48-AWT
850-V48-SOK

JAMES MARTIN

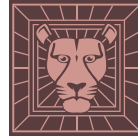

VANITIES™

Metropolitan 1219mm Cabinet

Diagrams with Dimensions
page 01 of 03

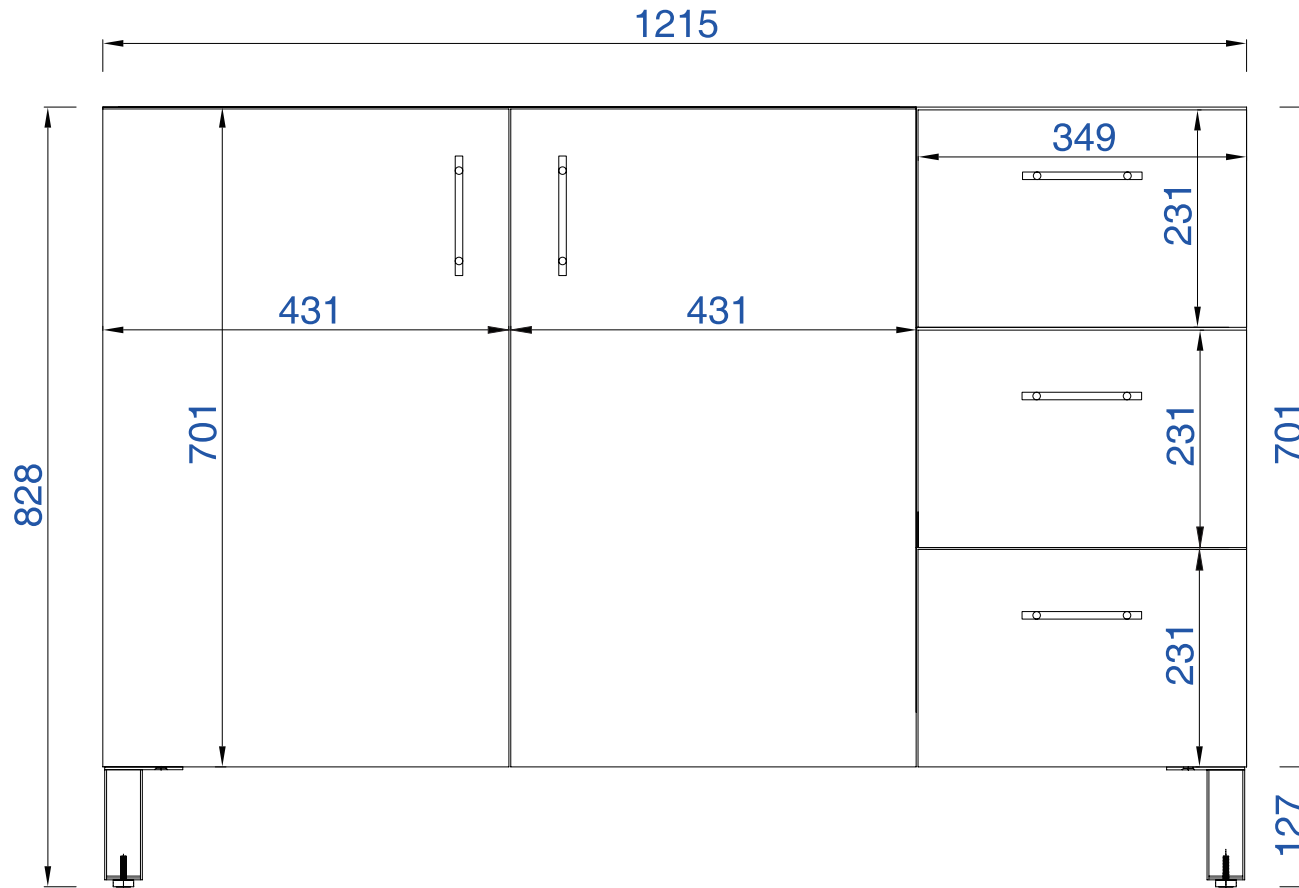

NOTE ONE: Countertops are not shown in these diagrams. (Cabinet Only)

NOTE TWO: This vanity does not have a Backsplash.

Please consult our website for Countertop Diagrams: www.jamesmartinvanities.com

1219mm

Item Number:

850-V48-AWT
850-V48-SOK

JAMES MARTIN

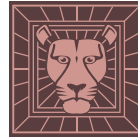

VANITIES™

Metropolitan 1219mm Cabinet

Diagrams with Dimensions
page 02 of 03

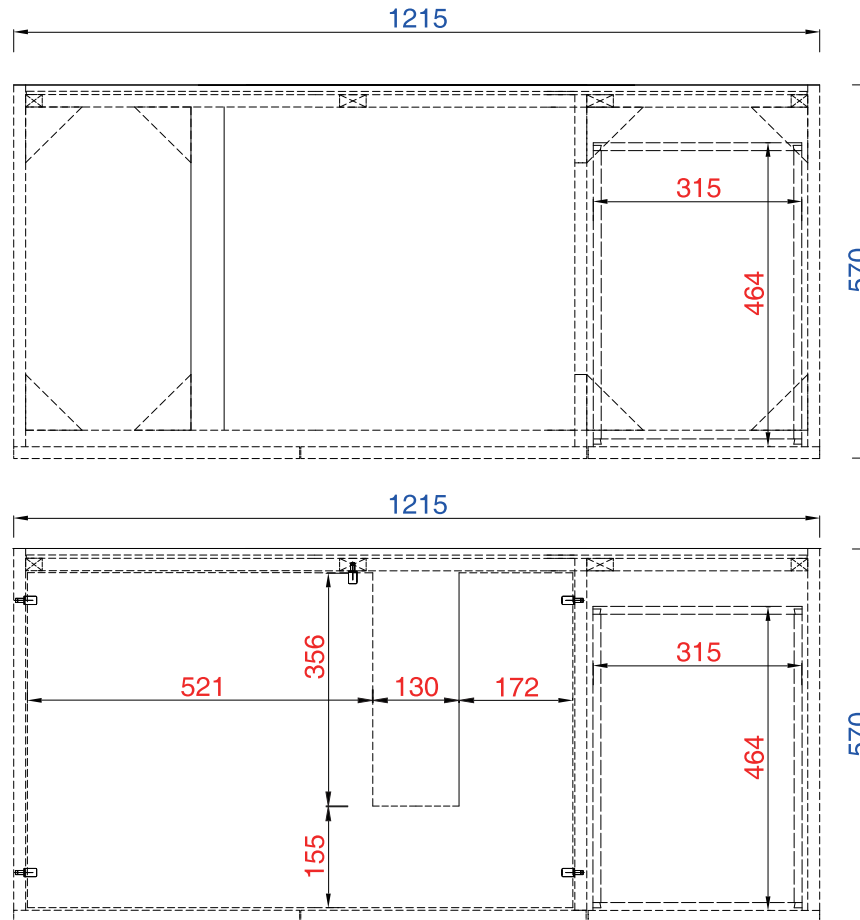

NOTE ONE: Countertops are not shown in these diagrams. (Cabinet Only)

NOTE TWO: Internal Shelves (Shown) are designed to align with sinks in James Martin's Optional Countertops. Customers' own countertops and sinks may align differently, and modification may be required. Please consult our website for Countertop Diagrams: www.jamesmartinvanities.com

1219mm

Item Number:

850-V48-AWT
850-V48-SOK

JAMES MARTIN



VANITIES™

Metropolitan 1219mm Cabinet

Diagrams with Dimensions
page 03 of 03

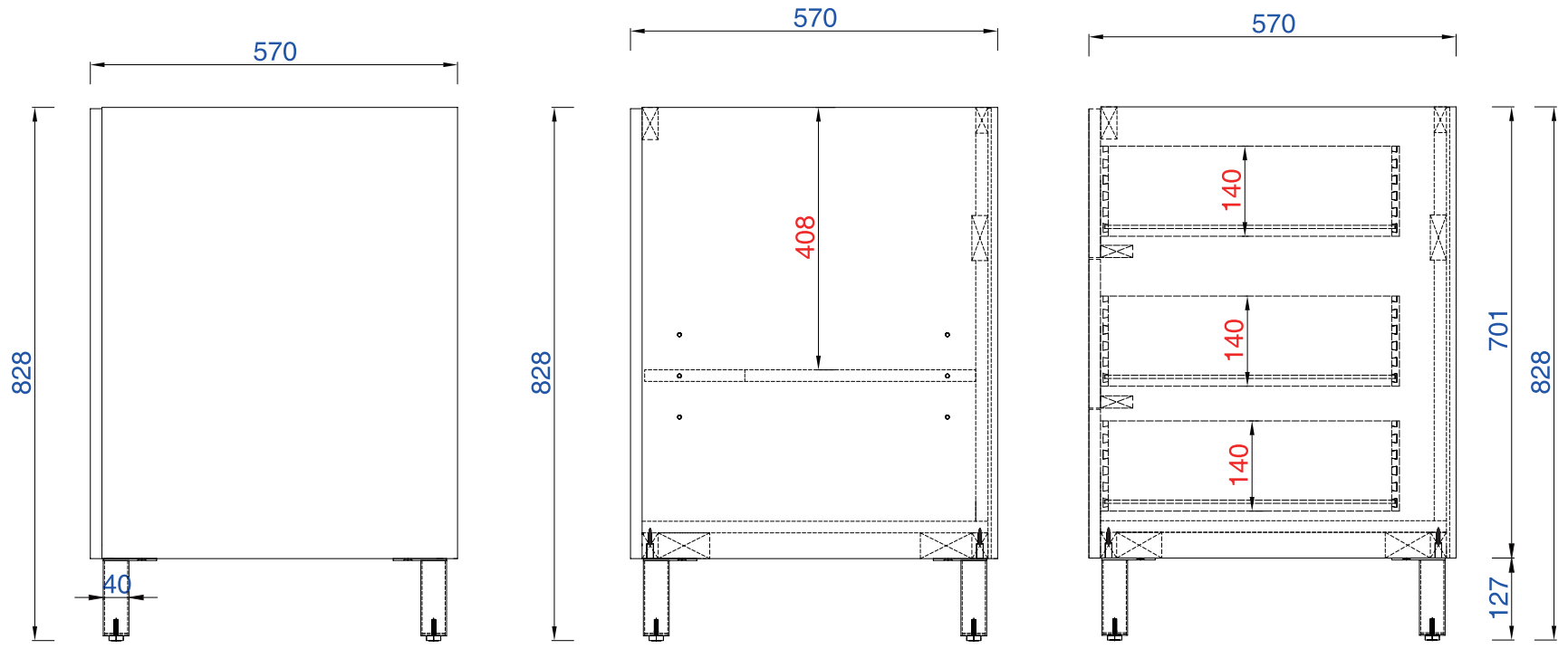

NOTE ONE: Countertops are not shown in these diagrams. (Cabinet Only)
NOTE TWO: This vanity does not have a Backsplash.
Please consult our website for Countertop Diagrams: www.jamesmartinvanities.com



48" Vanity Top Spec Sheet

James Martin Vanities Company always recommends you consult and/or hire a professional contractor when installing your vanity cabinet and top.

3cm/1.18"
Countertop

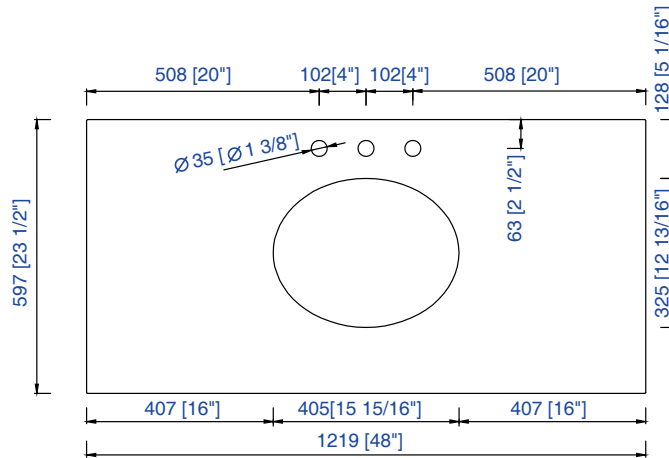

James Martin - Natural Stone Countertop Measurement Specification

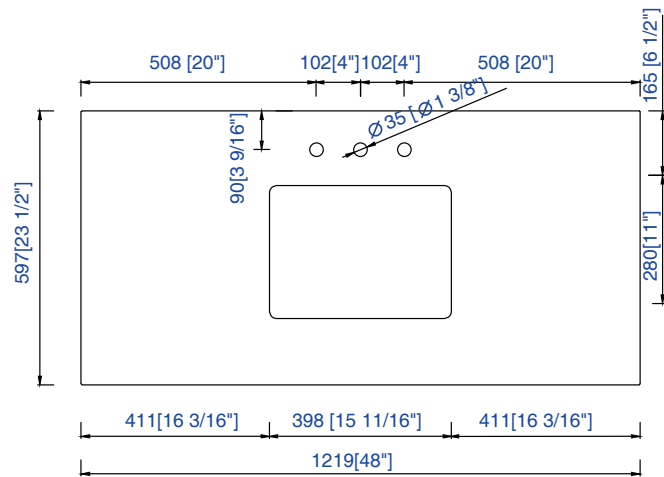

James Martin - Natural Stone & Solid Surface Countertop Measurement Specification

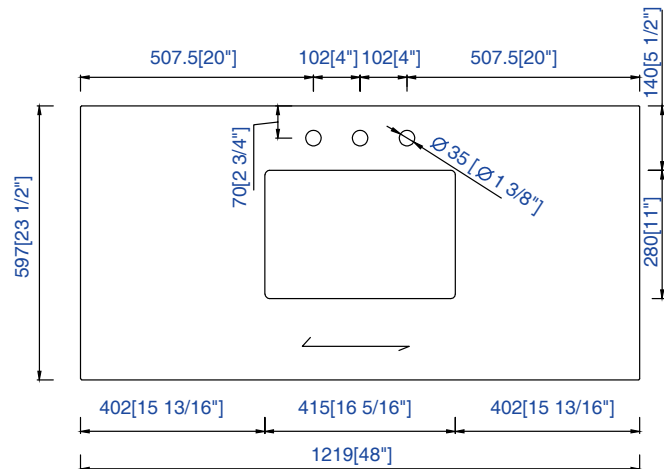

James Martin - Quartz Countertop Measurement Specification