

1505/1525-WV 24

Step 1

Detach mounting bracket from vanity

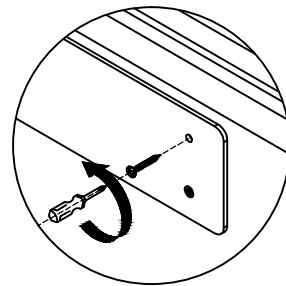

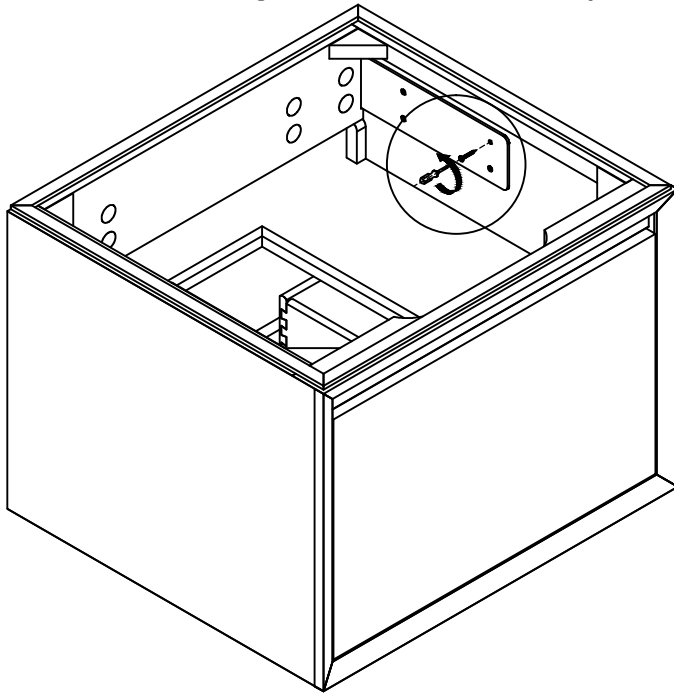

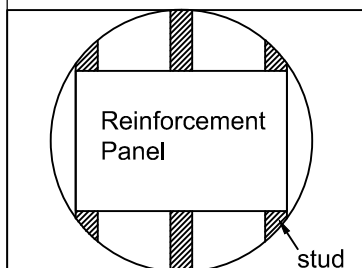



Cut opening in wall



Reinforcement Panel

* large enough to cover 2 studs

* not provided by manufacturer

PARTS INCLUDED			TOOLS AND MATERIALS		
1	 50*50*50*3MM	2 PCS	  		
2	 $\Phi 8 \times 38\text{mm}$	12 PCS			
3	 $\Phi 3.5 \times 15\text{MM}$	4 PCS			
			Screwdriver	Tape measure	Pencil

Fairmont Designs highly recommends that you seek a professional installation specialist if you are unsure of installation. Please note: Fairmont Designs is not responsible for any installation error, damages or injuries, actual or consequential resulting from possible printing error in instruction

1505/1525-WV 24

Step 2 Mounting bracket must be attached to reinforcement panel

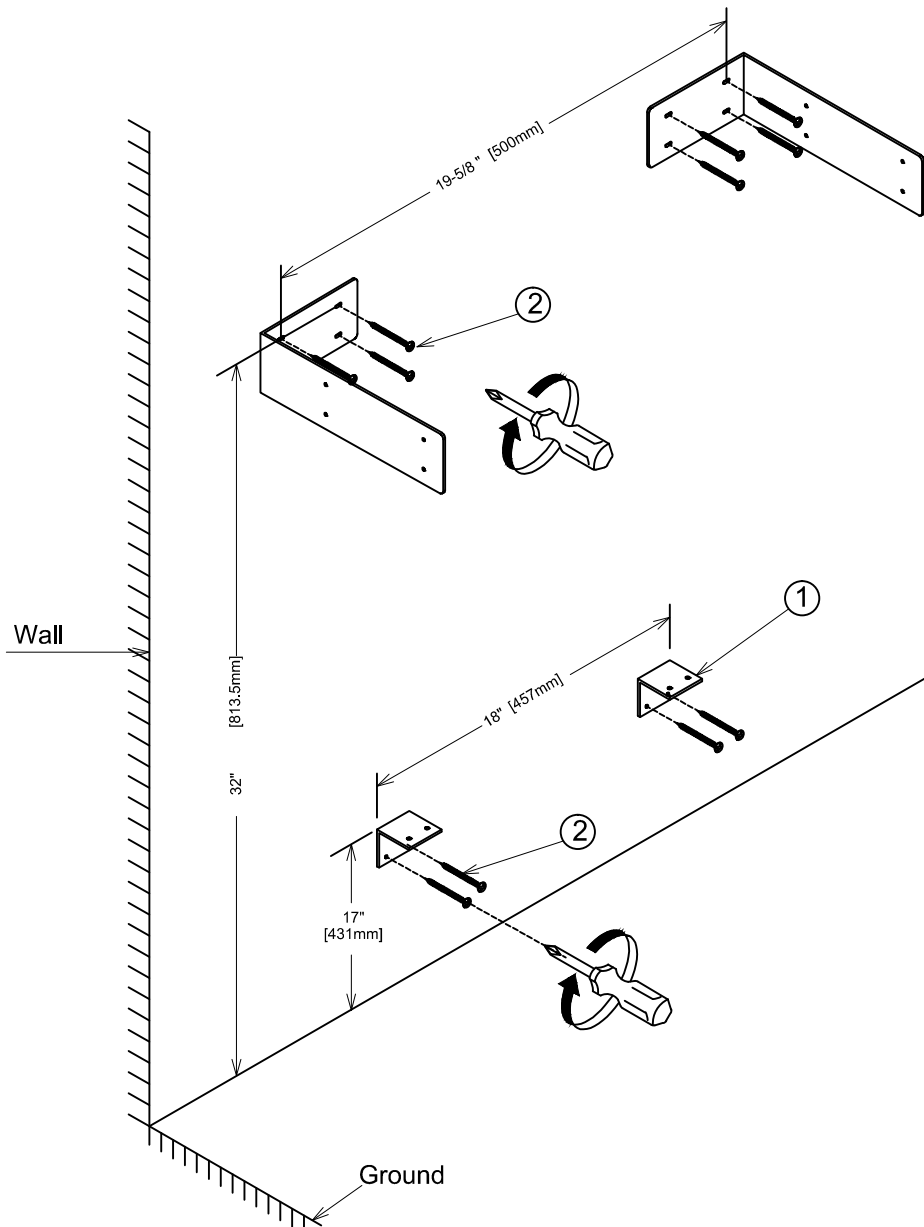

Fairmont Designs highly recommends that you seek a professional installation specialist if you are unsure of installation. Please note: Fairmont Designs is not responsible for any installation error, damages or injuries, actual or consequential resulting from possible printing error in instruction

1505/1525-WV 24

Step 3

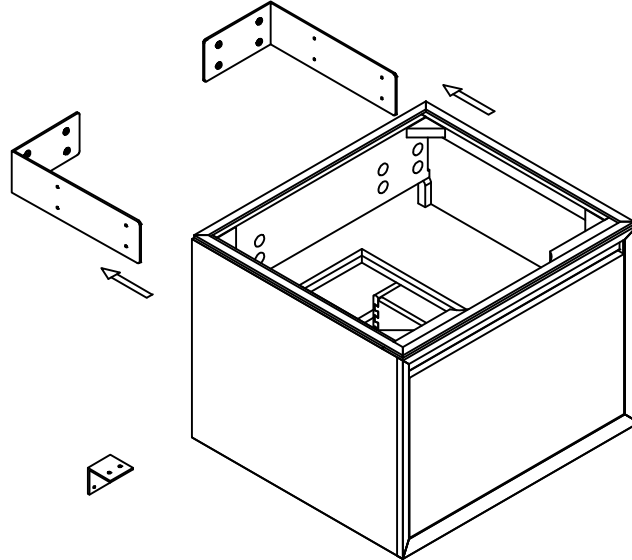

Step 4

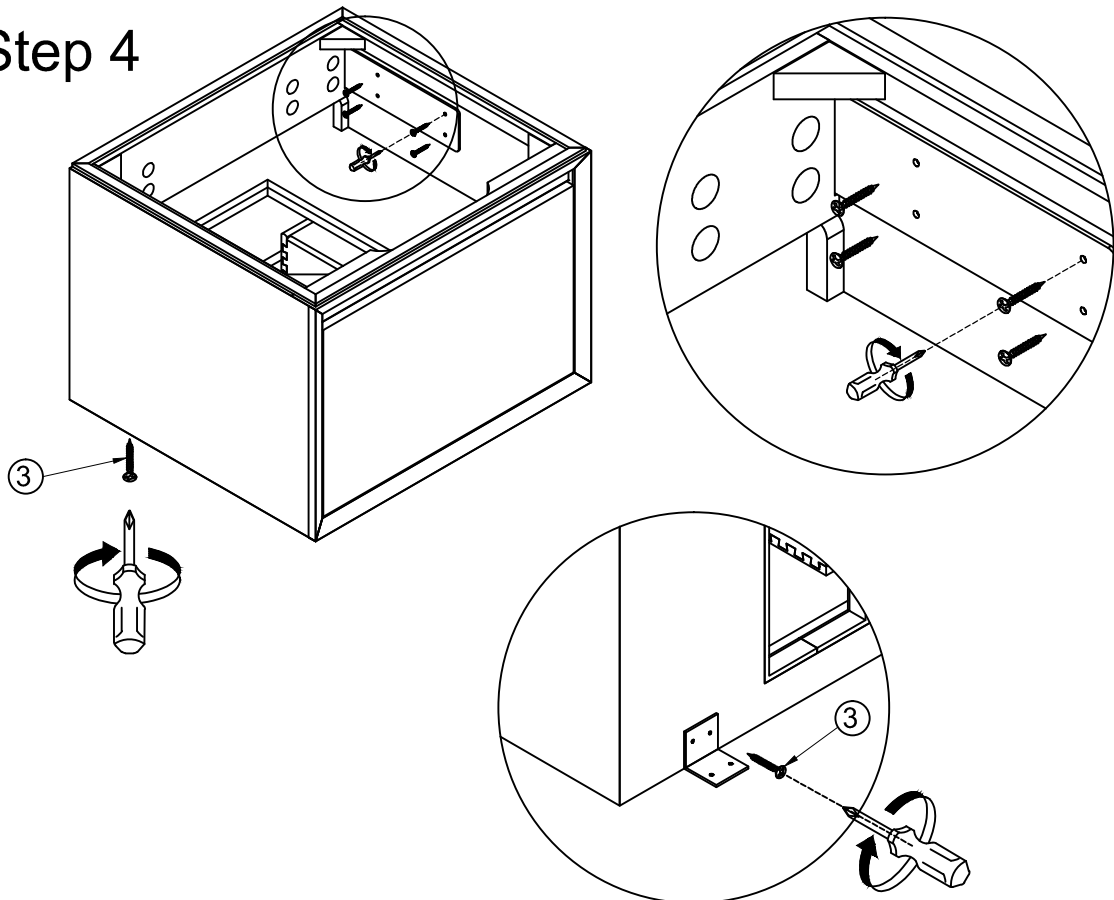

Fairmont Designs highly recommends that you seek a professional installation specialist if you are unsure of installation. Please note: Fairmont Designs is not responsible for any installation error, damages or injuries, actual or consequential resulting from possible printing error in instruction