

# SERENITY 37 – SERENITY SERIES

inches (mm)

66 x 38 x 29 (1675 x 965 x 735) • Fax on Demand #1321

SOAKER MODEL #AI37AIR6638TO

AIR BATH MODEL #AI37AIR6638



Note: This model requires a remote blower location. Please refer to the owners manual for detailed installation instructions.

## FEATURES (ALL MODELS)

- Freestanding bath
- Deep bathing well
- Slip-resistant floor
- Lucite® cast acrylic surface
- Design styles from transitional to modern
- Claw feet:  
Chrome, Oil-Rubbed Bronze, Polished Brass, Brushed Nickel, White
- Limited lifetime warranty
- UL and IAPMO listed

## OPTIONS

- Comfort pillow:  
Biscuit, Black, White
- Freestanding waste & overflow:  
Chrome, Oil Rubbed Bronze, Polished Brass, Brushed Nickel, White

## AQUATIC ADVANTAGE

- National distribution
- 6 manufacturing facilities
- Private fleet
- Centralized customer service
- Field support
- 24-hour fax-on-demand

## COLOR & TRIM OPTIONS

Stock	Premium
Almond	Black
Bone	Cashmere
Biscuit	Mexican Sand
White	Red
	Sandbar
	Sterling Silver

## AVAILABLE SYSTEM

### AIR BATH

- Perimeter air channel lined with antimicrobial coating
- Variable-speed, heated-air blower and automated purge-and-dry cycle and water sensors
- Electronic control with wave and pulse features
- Factory run-tested

Note: The interior of bathing well and outside of bathing well can each be specified in a different color.



Two Person Bath



AQUATIC

The bath people

# SERENITY 37

66 x 38 x 29 (1675 x 965 x 735)  
inches (mm)

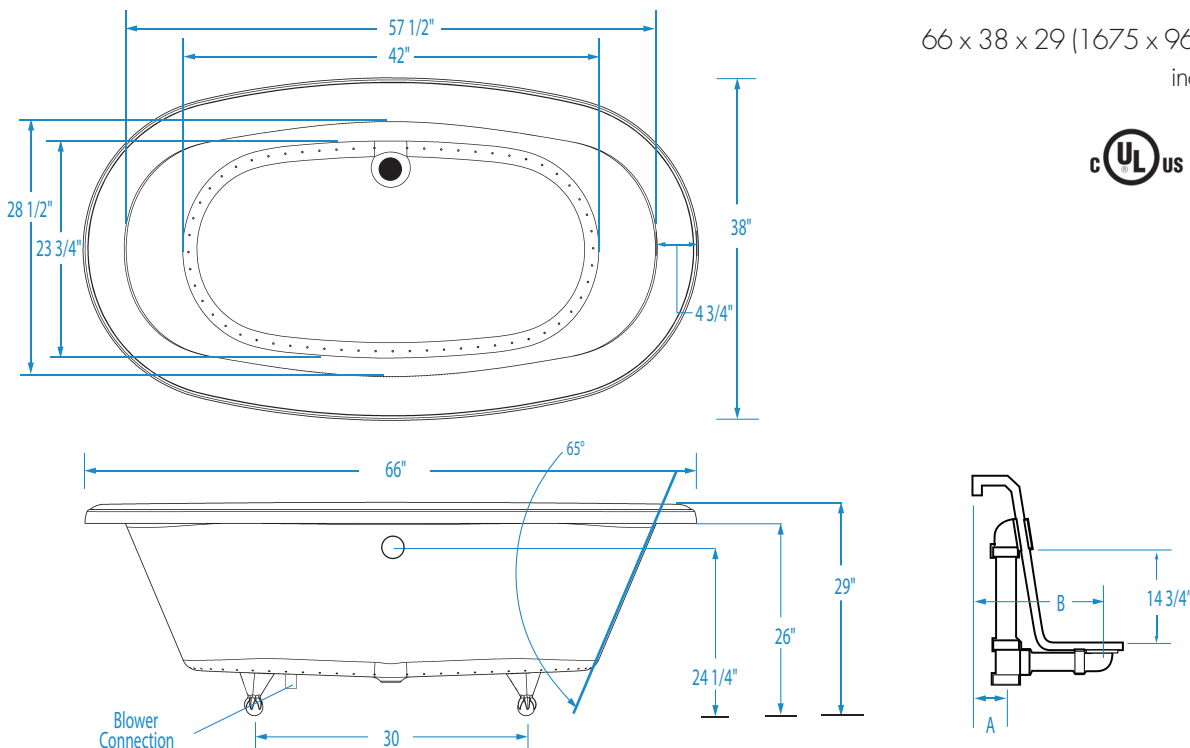

**FEATURES** lbs (kg) Dimensional Tolerance ± 3/8". Dimensions needed for site preparation should be measured from the unit. Aquatic assumes no responsibility for preparatory work.

Type and Model #	Material	System	Powered By	Heater	Controls	Drain	Pkg. Wt.
Soaker #AI37AIR6638TO	Acrylic	-	-	-	-	Center Front	255 (116)
Air Bath #AI37AIR6638	Acrylic	Air channel	Variable speed blower	Integrated	Electronic	Center Front	285 (129)

**DIMENSIONS** inches (mm)

Width Overall / Net	Depth Overall / Net	Height Overall / Net	Skirt Height
66 (1675)	38 (965)	29 (735)	-

**SUMP DATA** inches (mm)

Capacity to Overflow gal (ltr)	Min. Operating Capacity gal (ltr)	WIDTH @ centerline		DEPTH @ centerline	
		Top	Bottom	Top	Bottom
61 (230)	-	57 1/2 (1460)	42 (1065)	28 1/2 (725)	23 3/4 (605)

**PLUMBING DIMENSIONS** inches (mm)

A	B	Drain Diameter / Clearance
3 1/2 (90)	11 (280)	

**ELECTRICAL DATA**

Component	Specification	Requirement
Heated Blower (Air Bath)	10.5 AMP; 120V	15 AMP; 120V, separate circuit; Class A GFCI

**NOTES:**

1) Where applicable, utilize cut-out templates packed with unit for deck cutouts.

2) 16 x 16 (405 x 405) minimum access required at pump/blower location(s).

Each Serenity air bath is equipped with an air heating system to raise the temperature of the air entering the bath. This air temperature will be lower than the bathing temperature of the water, but will help reduce rapid decrease in water temperature. In addition, the air coming from the air jets will feel cool against the skin. This system does not heat the water.

#### AIR BATH

Center Drain Models

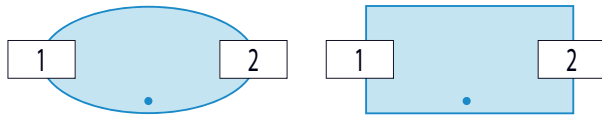

End Drain Models

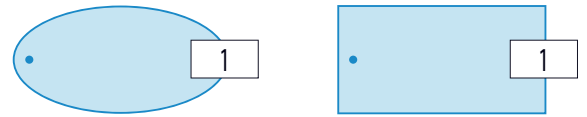

#### HOTSOAK

Center Drain Models

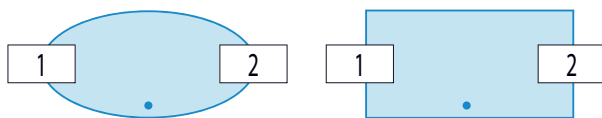

End Drain Models

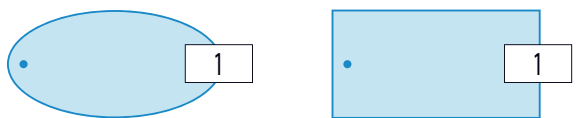

#### DRIFTBATH

Center Drain Models

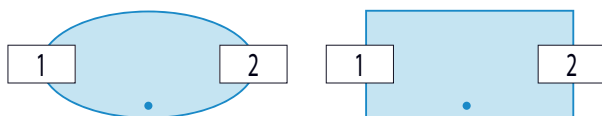

End Drain Models

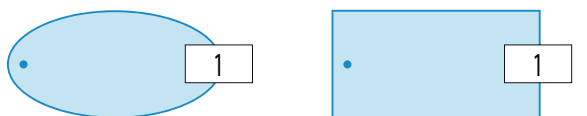

Center Drain Models

