

SERENITY 36 – SERENITY SERIES

inches (mm)

65 3/4 x 42 x 24 (1670 x 1065 x 610) • Fax on Demand #1318

SOAKER MODEL #AI36AIR6642TO

AIR BATH MODEL #AI36AIR6642

HOTSOAK MODEL #AI36AIR6642HS

DRIFTBATH MODEL #AI36AIR6642DB



FEATURES

- Deep bathing well
- Slip-resistant floor
- Pre-leveled ABS support base
- Lucite® cast acrylic surface
- Design styles from transitional to modern
- Limited lifetime warranty
- UL and IAPMO listed

OPTIONS

- Studio Lights Package: 4 high-intensity LEDs, contemporary keypad (air baths)
- Comfort pillow: Biscuit, Black, White
- Bolt-on grab bar(s): Chrome, Oil-Rubbed Bronze, Polished Brass, Brushed Nickel, Color Matched (Biscuit, White)
- Cable drive waste & overflow: Chrome, Oil Rubbed Bronze, Polished Brass, Brushed Nickel, Color Matched (Biscuit, Bone, White)
- Integral tile flange
- Remote control kit (Air bath only)
- Remote blower wiring kit (Air bath only)
- 1" Low Profile Deck (Skirt option not available with Low Profile Deck)

COLOR & TRIM OPTIONS

Stock	Premium
Almond	Black
Bone	Cashmere
Biscuit	Mexican Sand
White	Red
	Sandbar
	Sterling Silver

AQUATIC ADVANTAGE

- National distribution
- 6 manufacturing facilities
- Private fleet
- Centralized customer service
- Field support
- 24-hour fax-on-demand

AVAILABLE SYSTEMS

AIR BATH

- Perimeter air channel lined with antimicrobial coating
- Variable-speed, heated-air blower and automated purge-and-dry cycle and water sensors
- Electronic control with wave and pulse features
- Chromotherapy
- Factory run-tested

HOTSOAK

- 2 low-profile circulation portals
- 1.5kW inline maintenance heater
- Quiet, run-dry safe pump
- Electronic one-touch off/on control
- Quiet pad anti-vibration pump mount
- Heatbent rigid PVC piping
- Factory run-tested

DRIFTBATH

- Up to 70 water-only portals
- Quiet 3/4 hp pump with integrated heat
- Electronic control
- 4 high-intensity LED chromotherapy lights
- Available in White or Biscuit



SERENITY 36

 65 3/4 x 42 x 24 (1670 x 1065 x 610)
 inches (mm)

Note: Drop-in Serenity models feature a Pre-leveled ABS Support Base.

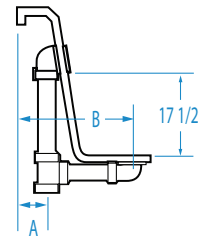
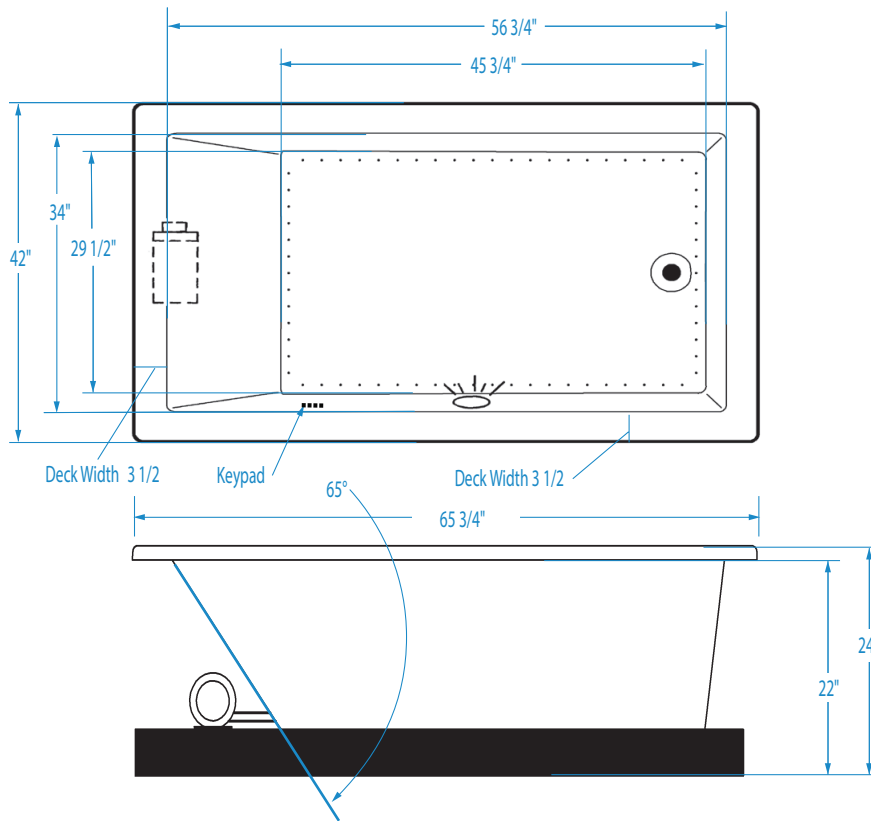
FEATURES lbs (kg) Dimensional Tolerance ± 3/8". Dimensions needed for site preparation should be measured from the unit. Aquatic assumes no responsibility for preparatory work.

Type and Model #	Material	System	Powered By	Heater	Controls	Drain	Pkg. Wt.
Soaker #AI36AIR6642TO	Acrylic	-	-	-	-	Universal	158 (72)
HotSoak #AI36AIR6642HS	Acrylic	Water circulation	Pump	1.5 kW Inline maintenance	Electronic	Universal	188 (85)
Air Bath #AI36AIR6642	Acrylic	Air channel	Variable speed blower	Integrated	Electronic	Universal	188 (85)
DriftBath #AI36AIR6642DB	Acrylic	Water circulation	Pump	Integrated	Electronic	Universal	199 (90)

DIMENSIONS inches (mm)

Width Overall / Net	Depth Overall / Net	Height Overall / Net	Skirt Height
65 3/4 (1670)	42 (1065)	24 (610)	-

SUMP DATA inches (mm)

Capacity to Overflow gal (ltr)	Min. Operating Capacity gal (ltr)	WIDTH @ centerline		DEPTH @ centerline	
		Top	Bottom	Top	Bottom
115 (435)	-	56 3/4 (1440)	45 3/4 (1160)	34 (865)	29 1/2 (750)

PLUMBING DIMENSIONS inches (mm)

A	B	Drain Diameter / Clearance
3 (75)	10 1/2 (270)	2 (50) / 1 3/4 (50)

ELECTRICAL DATA

Component	Specification	Requirement
Heated Blower (Air Bath)	10.5 AMP; 120V	15 AMP; 120V, separate circuit; Class A GFCI
Pump (HotSoak)	1/15 HP; 1.3 AMP; 120V	20 AMP; 120V, separate circuit; Class A GFCI
Heater (HotSoak)	1.5 kW; 12 AMP; 120V	
Pump (DriftBath)	3/4 HP; 8.8 AMP; 120V	15 AMP; 120V, separate circuit; Class A GFCI

NOTES:

1) Where applicable, utilize cut-out templates packed with unit for deck cutouts.

2) 16 x 16 (405 x 405) minimum access required at pump/blower location(s).

3) For Low Profile Deck, framing height will need to be increased by an additional 1".

4) If a (3T) tiling flange is selected, then the keypad is located opposite of the flange.

Each Serenity air bath is equipped with an air heating system to raise the temperature of the air entering the bath. This air temperature will be lower than the bathing temperature of the water, but will help reduce rapid decrease in water temperature. In addition, the air coming from the air jets will feel cool against the skin. This system does not heat the water.

SERENITY

PUMP/BLOWER LOCATIONS

TECHNICAL SPECIFICATIONS

Air Bath • HotSoak • DriftBath

AIR BATH

Center Drain Models

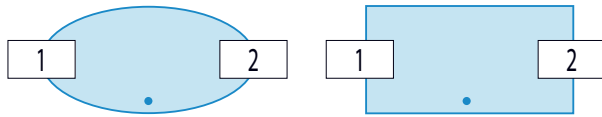

End Drain Models

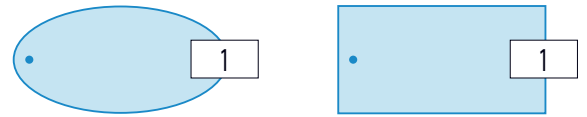

HOTSOAK

Center Drain Models

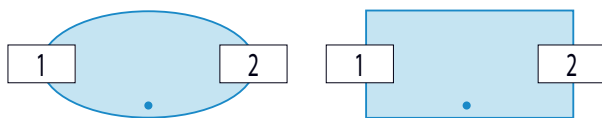

End Drain Models

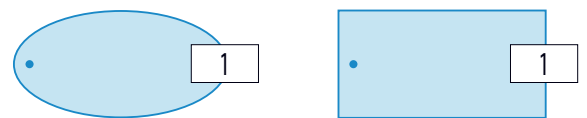

DRIFTBATH

Center Drain Models

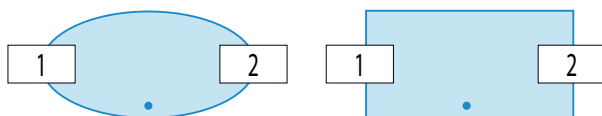

End Drain Models



Center Drain Models

