

# SERENITY 31 MOTIF — SERENITY SERIES

inches (mm)

66 1/2 x 36 3/4 x 25 (1690 x 935 x 635) • Fax on Demand #1302

**SOAKER MODEL #AI31AIR6636TO**

**AIR BATH MODEL #AI31AIR6636**

**HOTSOAK MODEL #AI31AIR6636HS**

**DRIFTBATH MODEL #AI31AIR6636DB**



## FEATURES

- Deep bathing well
- Slip-resistant floor
- Pre-leveled ABS support base
- Lucite® cast acrylic surface
- Design styles from transitional to modern
- Limited lifetime warranty
- UL and IAPMO listed

## OPTIONS

- Studio Lights Package: 4 high-intensity LEDs, contemporary keypad (air baths)
- Comfort pillow: Biscuit, Black, White
- Bolt-on grab bar(s): Chrome, Oil-Rubbed Bronze, Polished Brass, Brushed Nickel, Color Matched (Biscuit, White)
- Cable drive waste & overflow: Chrome, Oil Rubbed Bronze, Polished Brass, Brushed Nickel, Color Matched (Biscuit, Bone, White)
- Optional blower/pump location
- Remote control kit (Air bath only)
- Remote blower wiring kit (Air bath only)

## COLOR & TRIM OPTIONS

Stock	Premium
Almond	Black
Bone	Cashmere
Biscuit	Mexican Sand
White	Red
	Sandbar
	Sterling Silver

## AQUATIC ADVANTAGE

- National distribution
- 6 manufacturing facilities
- Private fleet
- Centralized customer service
- Field support
- 24-hour fax-on-demand

## AVAILABLE SYSTEMS

### AIR BATH

- Perimeter air channel lined with antimicrobial coating
- Variable-speed, heated-air blower and automated purge-and-dry cycle and water sensors
- Electronic control with wave and pulse features
- Chromatherapy
- Factory run-tested

### HOTSOAK

- 2 low-profile circulation portals
- 1.5kW inline maintenance heater
- Quiet, run-dry safe pump
- Electronic one-touch off/on control
- Quiet pad anti-vibration pump mount
- Heatbent rigid PVC piping
- Factory run-tested

### DRIFTBATH

- Up to 70 water-only portals
- Quiet 3/4 hp pump with integrated heat
- Electronic control
- 4 high-intensity LED chromatherapy lights
- Available in White or Biscuit



# SERENITY 31 MOTIF

 66 1/2 x 36 3/4 x 25 (1690 x 935 x 635)  
 inches (mm)

Note: Drop-in Serenity models feature a Pre-leveled ABS Support Base.

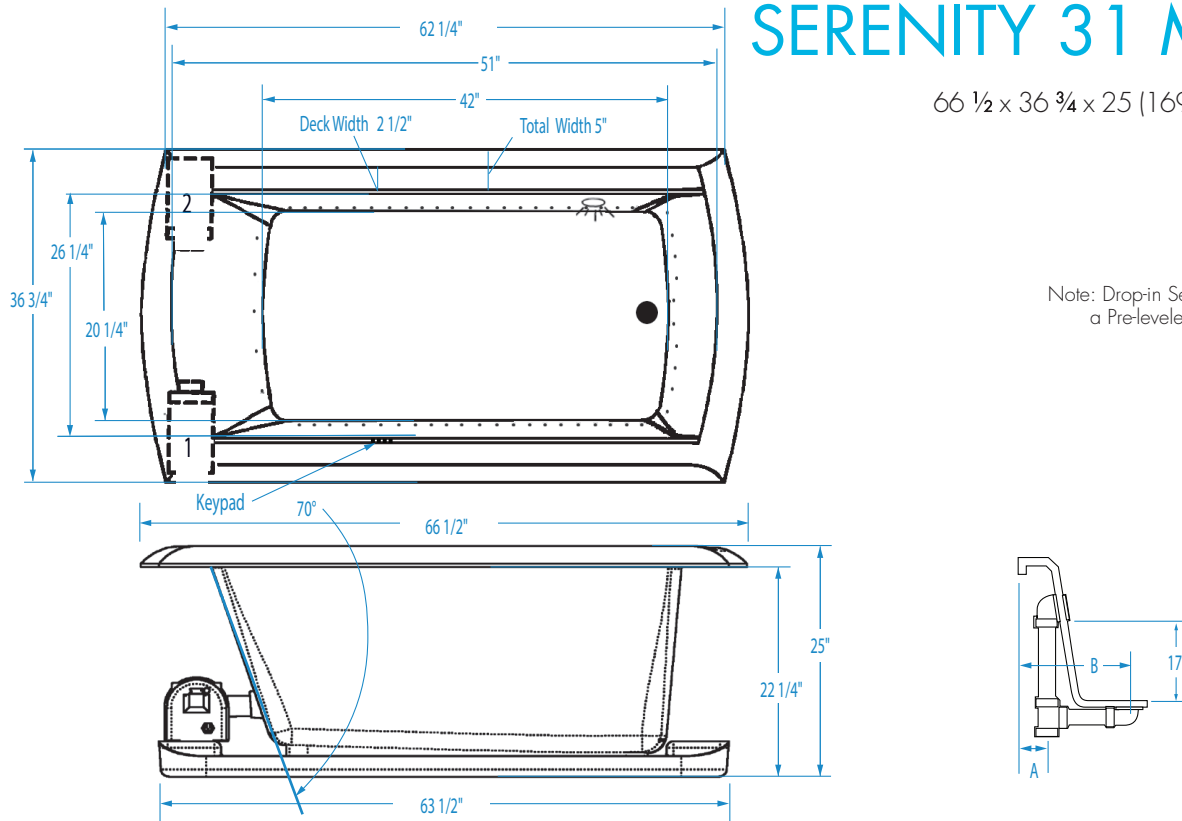
**FEATURES** lbs (kg) Dimensional Tolerance ± 3/8". Dimensions needed for site preparation should be measured from the unit. Aquatic assumes no responsibility for preparatory work.

Type and Model #	Material	System	Powered By	Heater	Controls	Drain	Pkg. Wt.
Soaker #AI31AIR6636TO	Acrylic	-	-	-	-	Universal	181 (82)
HotSoak #AI31AIR6636HS	Acrylic	Water circulation	Pump	1.5 kW Inline maintenance	Electronic	Universal	211 (96)
Air Bath #AI31AIR6636	Acrylic	Air channel	Variable speed blower	Integrated	Electronic	Universal	211 (96)
DriftBath #AI31AIR6636DB	Acrylic	Water circulation	Pump	Integrated	Electronic	Universal	222 (101)

**DIMENSIONS** inches (mm)

Width Overall / Net	Depth Overall / Net	Height Overall / Net	Skirt Height
66 1/2 (1690)	36 3/4 (935)	25 (635)	-

**SUMP DATA** inches (mm)

Capacity to Overflow gal (ltr)	Min. Operating Capacity gal (ltr)	WIDTH @ centerline		DEPTH @ centerline	
		Top	Bottom	Top	Bottom
76 (288)	-	51 (1295)	42 (1065)	26 1/4 (665)	20 1/4 (515)

**PLUMBING DIMENSIONS** inches (mm)

A	B	Drain Diameter / Clearance
5 1/2 (140)	13 1/2 (345)	

**ELECTRICAL DATA**

Component	Specification	Requirement
Heated Blower (Air Bath)	10.5 AMP; 120V	15 AMP; 120V, separate circuit; Class A GFCI
Pump (HotSoak)	1/15 HP; 1.3 AMP; 120V	20 AMP; 120V, separate circuit; Class A GFCI
Heater (HotSoak)	1.5 kW; 12 AMP; 120V	
Pump (DriftBath)	3/4 HP; 8.8 AMP; 120V	15 AMP; 120V, separate circuit; Class A GFCI

**NOTES:**

- Where applicable, utilize cut-out templates packed with unit for deck cutouts.
- 16 x 16 (405 x 405) minimum access required at pump/blower location(s).
- If a (3T) tiling flange is selected, then the keypad is located opposite of the flange.

Each Serenity air bath is equipped with an air heating system to raise the temperature of the air entering the bath. This air temperature will be lower than the bathing temperature of the water, but will help reduce rapid decrease in water temperature. In addition, the air coming from the air jets will feel cool against the skin. This system does not heat the water.

# SERENITY

## PUMP/BLOWER LOCATIONS

### TECHNICAL SPECIFICATIONS

Air Bath • HotSoak • DriftBath

#### AIR BATH

Center Drain Models

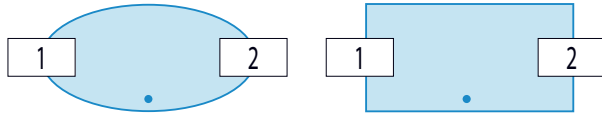

End Drain Models

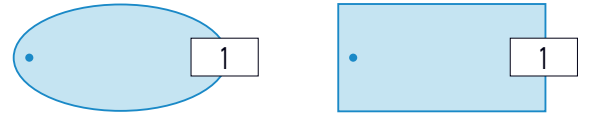

#### HOTSOAK

Center Drain Models

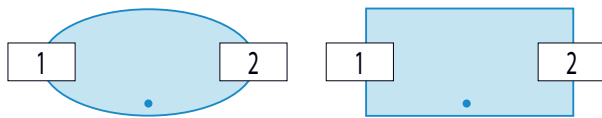

End Drain Models

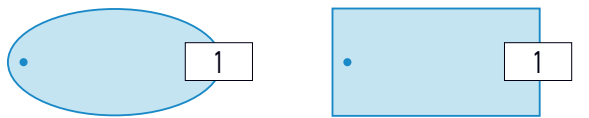

#### DRIFTBATH

Center Drain Models

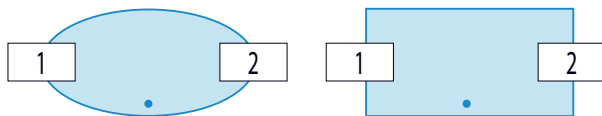

End Drain Models

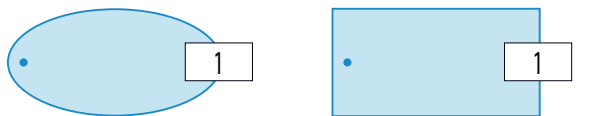

Center Drain Models

