

SERENITY 11 – SERENITY SERIES

inches (mm)

71 ¾ x 39 ½ x 27 (1820 x 1005 x 685) • Fax on Demand #1190

SOAKER MODEL #A111AIR7240PTO

AIR BATH MODEL #A111AIR7240P



Note: This model requires a remote blower location. Please refer to the owners manual for detailed installation instructions.

FEATURES (ALL MODELS)

- Freestanding bath
- Deep bathing well
- Slip-resistant floor
- Lucite® cast acrylic surface
- Design styles from transitional to modern
- Limited lifetime warranty
- UL and IAPMO listed

OPTIONS

- Comfort pillow:
Biscuit, Black, White
- Freestanding waste & overflow:
Chrome, Oil Rubbed Bronze,
Polished Brass, Brushed Nickel,
White

AQUATIC ADVANTAGE

- National distribution
- 6 manufacturing facilities
- Private fleet
- Centralized customer service
- Field support
- 24-hour fax-on-demand

COLOR & TRIM OPTIONS

Stock	Premium
Almond	Black
Bone	Cashmere
Biscuit	Mexican Sand
White	Red
	Sandbar
	Sterling Silver

AVAILABLE SYSTEM

AIR BATH

- Perimeter air channel lined with antimicrobial coating
- Variable-speed, heated-air blower and automated purge-and-dry cycle and water sensors
- Electronic control with wave and pulse features
- Factory run-tested

Note: The interior of bathing well and outside of bathing well can each be specified in a different color.



Two Person Bath



ICC ES
C. Compliance with PMG



AQUATIC

The bath people

SERENITY 11

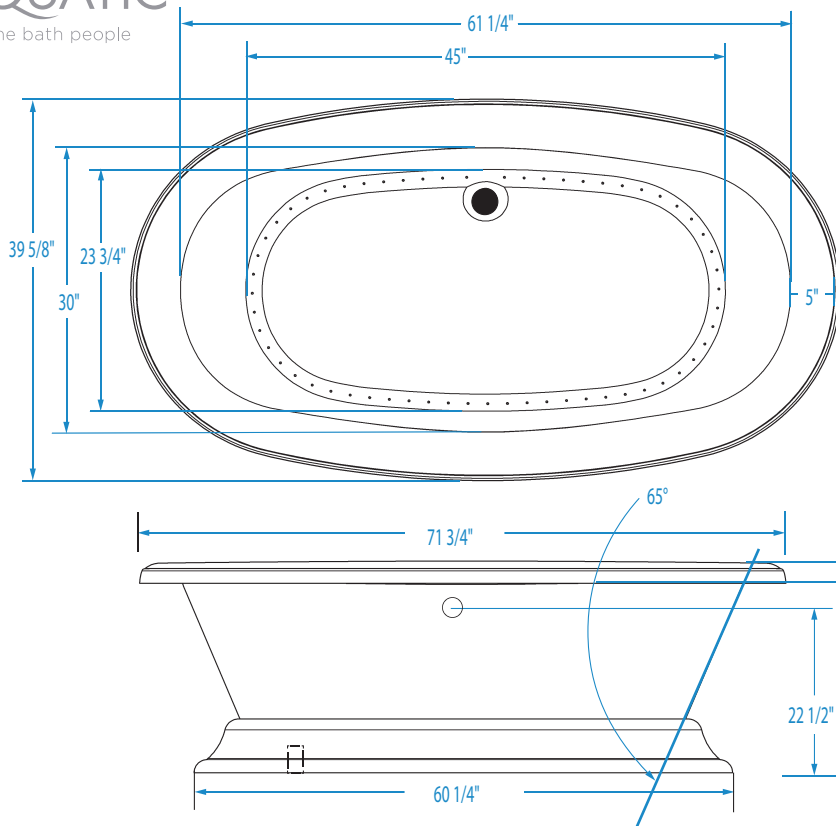
 71 ¾ x 39 ⅝ x 27 (1820 x 1005 x 685)
 inches (mm)

FEATURES lbs (kg) Dimensional Tolerance ± 3/8". Dimensions needed for site preparation should be measured from the unit. Aquatic assumes no responsibility for preparatory work.

Type and Model #	Material	System	Powered By	Heater	Controls	Drain	Pkg. Wt.
Soaker #A111AIR7240PTO	Acrylic	-	-	-	-	Center Front	519 (235)
Air Bath #A111AIR7240P	Acrylic	Air channel	Variable speed blower	Inline	Electronic	Center Front	549 (249)

DIMENSIONS inches (mm)

Width Overall / Net	Depth Overall / Net	Height Overall / Net	Skirt Height
71 ¾ (1820)	39 ⅝ (1005)	27 (685)	-

SUMP DATA inches (mm)

Capacity to Overflow gal (ltr)	Min. Operating Capacity gal (ltr)	WIDTH @ centerline		DEPTH @ centerline	
		Top	Bottom	Top	Bottom
78 (295)	-	61 ¼ (1555)	45 (1145)	30 (760)	23 ¾ (605)

PLUMBING DIMENSIONS inches (mm)

A	B	Drain Diameter / Clearance
4 ¾ (120)	12 ⅞ (310)	2 (50) / 4 ¾ (115)

ELECTRICAL DATA

Component	Specification	Requirement
Heated Blower (Air Bath)	10.5 AMP; 120V	1.5 AMP; 120V, separate circuit; Class A GFCI

NOTES:

1) Where applicable, utilize cut-out templates packed with unit for deck cutouts.

2) 16 x 16 (405 x 405) minimum access required at pump/blower location(s).

Each Serenity air bath is equipped with an air heating system to raise the temperature of the air entering the bath. This air temperature will be lower than the bathing temperature of the water, but will help reduce rapid decrease in water temperature. In addition, the air coming from the air jets will feel cool against the skin. This system does not heat the water.

AIR BATH

Center Drain Models

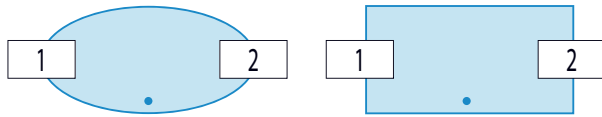

End Drain Models

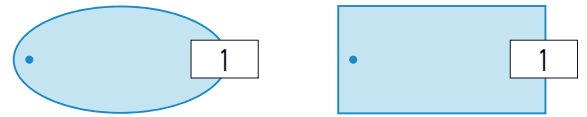

HOTSOAK

Center Drain Models

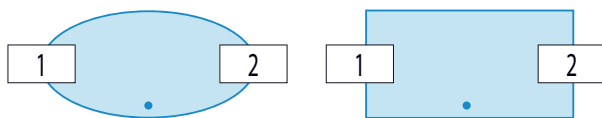

End Drain Models

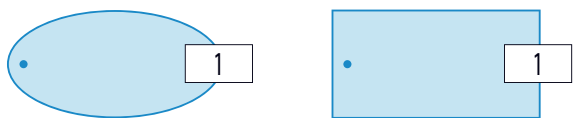

DRIFTBATH

Center Drain Models

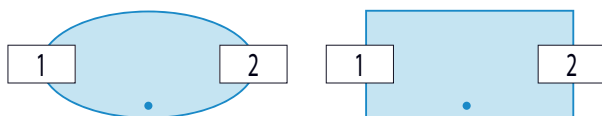

End Drain Models

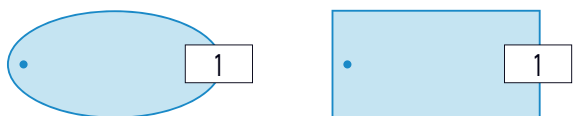

Center Drain Models

