

# SERENITY 7 – SERENITY SERIES

inches (mm)

59 1/2 x 41 7/8 x 23 (1510 x 1065 x 585) • Fax on Demand #1265

SOAKER MODEL #AI7AIR6042TO

AIR BATH MODEL #AI7AIR6042

HOTSOAK MODEL #AI7AIR6042HS

DRIFTBATH MODEL #AI7AIR6042DB

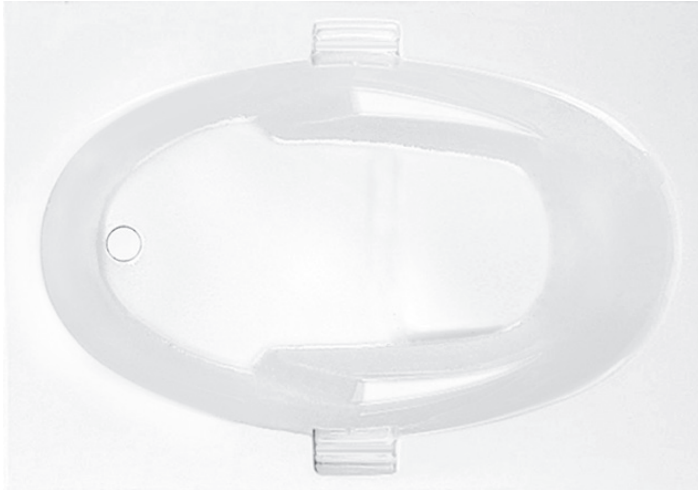

## FEATURES (ALL MODELS)

- Deep bathing well
- Slip-resistant floor
- Pre-leveled ABS support base
- Lucite® cast acrylic surface
- Design styles from transitional to modern
- Limited lifetime warranty
- UL and IAPMO listed

## OPTIONS

- Comfort pillow: Biscuit, Black, White
- Grab bar(s): Chrome, Oil Rubbed Bronze, Polished Brass, Brushed Nickel, Color matched (Biscuit, White, Clear)
- Cable drive waste & overflow: Chrome, Oil Rubbed Bronze, Polished Brass, Brushed Nickel, Color Matched (Biscuit, Bone, White)
- Factory installed rigid ABS tile flange
- Acrylic skirt: Color Matched
- Remote control kit (Air bath only)
- Remote blower wiring kit (Air bath only)
- 1" Low Profile Deck (Skirt option not available with Low Profile Deck)

## AQUATIC ADVANTAGE

- National distribution
- 6 manufacturing facilities
- Private fleet
- Centralized customer service
- Field support
- 24-hour fax-on-demand

## COLOR & TRIM OPTIONS

Stock	Premium
Almond	Black
Bone	Cashmere
Biscuit	Mexican Sand
White	Red
	Sandbar
	Sterling Silver

## AVAILABLE SYSTEMS

### AIR BATH

- Perimeter air channel lined with antimicrobial coating
- Variable-speed, heated-air blower and automated purge-and-dry cycle and water sensors
- Electronic control with wave and pulse features
- Chromatherapy
- Factory run-tested

### HOTSOAK

- 2 low-profile circulation portals
- 1.5kW inline maintenance heater
- Quiet, run-dry safe pump
- Electronic one-touch off/on control
- Quiet pad anti-vibration pump mount
- Heatbent rigid PVC piping
- Factory run-tested

### DRIFTBATH

- Up to 70 water-only portals
- Quiet 3/4 hp pump with integrated heat
- Electronic control
- 4 high-intensity LED chromatherapy lights
- Available in White or Biscuit



## SERENITY 7

59 1/2 x 41 7/8 x 23 (1510 x 1065 x 585) inches (mm)



Note: Drop-in Serenity models feature a Pre-leveled ABS Support Base.

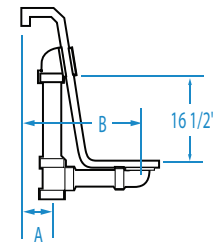
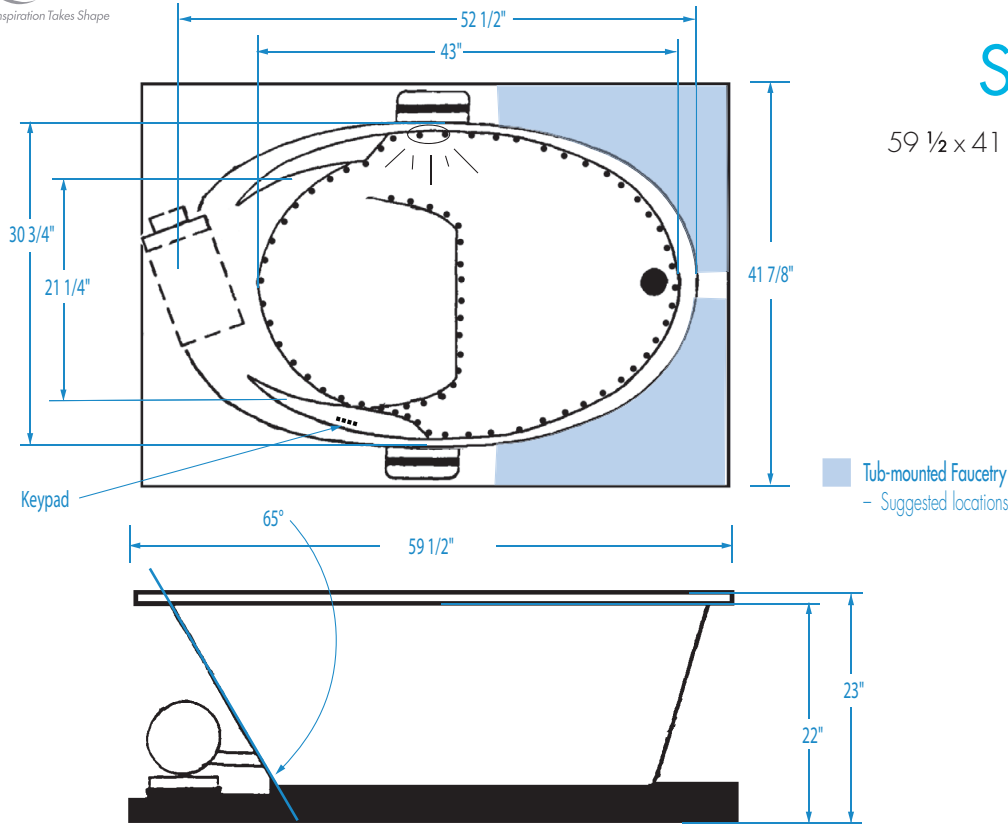

**FEATURES** lbs (kg) Dimensional Tolerance ± 3/8". Dimensions needed for site preparation should be measured from the unit. Aquatic assumes no responsibility for preparatory work.

Type and Model #	Material	System	Powered By	Heater	Controls	Drain	Pkg. Wt.
Soaker #AI7AIR6042TO	Acrylic	-	-	-	-	Universal	182 (83)
HotSoak #AI7AIR6042HS	Acrylic	Water circulation	Pump	1.5 kW Inline maintenance	Electronic	Universal	212 (96)
Air Bath #AI7AIR6042	Acrylic	Air channel	Variable speed blower	Integrated	Electronic	Universal	212 (96)
DriftBath #AI7AIR6042DB	Acrylic	Water circulation	Pump	Integrated	Electronic	Universal	223 (101)

### DIMENSIONS inches (mm)

Width Overall / Net	Depth Overall / Net	Height Overall / Net	Skirt Height
59 1/2 (1510)	41 7/8 (1065)	23 (585)	-

### SUMP DATA inches (mm)

Capacity to Overflow gal (ltr)	Min. Operating Capacity gal (ltr)	WIDTH @ centerline		DEPTH @ centerline	
		Top	Bottom	Top	Bottom
70 (265)	-	52 1/2 (1335)	43 (1090)	30 3/4 (780)	21 1/4 (540)

### PLUMBING DIMENSIONS inches (mm)

A	B	Drain Diameter / Clearance
2 1/4 (55)	9 3/4 (250)	

### ELECTRICAL DATA

Component	Specification	Requirement
Heated Blower (Air Bath)	10.5 AMP; 120V	15 AMP; 120V, separate circuit; Class A GFCI
Pump (HotSoak)	1/15 HP; 1.3 AMP; 120V	20 AMP; 120V, separate circuit; Class A GFCI
Heater (HotSoak)	1.5 kW; 12 AMP; 120V	
Pump (DriftBath)	3/4 HP; 8.8 AMP; 120V	15 AMP; 120V, separate circuit; Class A GFCI

#### NOTES:

1) Where applicable, utilize cut-out templates packed with unit for deck cutouts.

2) 16 x 16 (405 x 405) minimum access required at pump/blower location(s).

3) For Low Profile Deck, framing height will need to be increased by an additional 1".

4) If a (3T) tiling flange is selected, then the keypad is located opposite of the flange.

Each Serenity air bath is equipped with an air heating system to raise the temperature of the air entering the bath. This air temperature will be lower than the bathing temperature of the water, but will help reduce rapid decrease in water temperature. In addition, the air coming from the air jets will feel cool against the skin. This system does not heat the water.

# SERENITY

## PUMP/BLOWER LOCATIONS

### TECHNICAL SPECIFICATIONS

Air Bath • HotSoak • DriftBath

#### AIR BATH

Center Drain Models

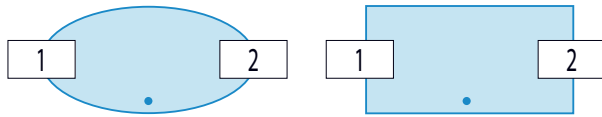

End Drain Models

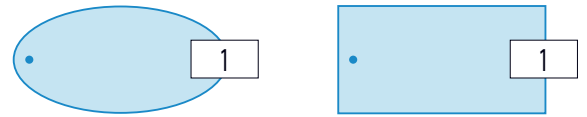

#### HOTSOAK

Center Drain Models

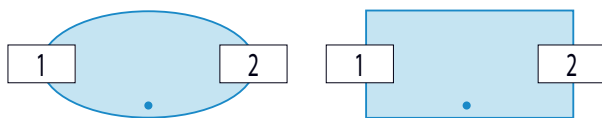

End Drain Models

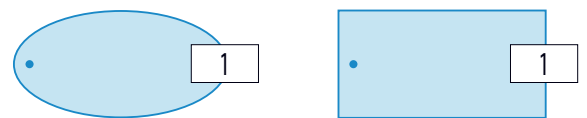

#### DRIFTBATH

Center Drain Models

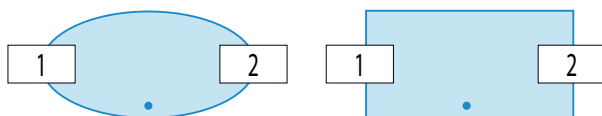

End Drain Models



Center Drain Models

