

SERENITY 4 – SERENITY SERIES

inches (mm)

59 1/2 x 32 x 24 (1510 x 815 x 610) • Fax on Demand #1259

SOAKER MODEL #A14AIR6032TO

AIR BATH MODEL #A14AIR6032

HOTSOAK MODEL #A14AIR6032HS

DRIFTBATH MODEL #A14AIR6032DB



AQUATIC ADVANTAGE

- National distribution
- 6 manufacturing facilities
- Private fleet
- Centralized customer service
- Field support
- 24-hour fax-on-demand

FEATURES (ALL MODELS)

- Deep bathing well
- Slip-resistant floor
- Pre-leveled ABS support base
- Lucite® cast acrylic surface
- Design styles from transitional to modern
- Limited lifetime warranty
- UL and IAPMO listed

OPTIONS

- Comfort pillow: Biscuit, Black, White
- Bolt-on grab bar(s):
Chrome, Oil-Rubbed Bronze,
Polished Brass, Brushed Nickel,
Color Matched (Biscuit, White)
- Cable drive waste & overflow:
Chrome, Oil Rubbed Bronze,
Polished Brass, Brushed Nickel,
Color Matched (Biscuit, Bone, White)
- Factory installed rigid ABS
tile flange
- Acrylic skirt: Color Matched
- Remote control kit (Air bath only)
- Remote blower wiring kit
(Air bath only)
- 1" Low Profile Deck (Skirt option not
available with Low Profile Deck)

COLOR & TRIM OPTIONS

Stock	Premium
Almond	Black
Bone	Cashmere
Biscuit	Mexican Sand
White	Red
	Sandbar
	Sterling Silver

AVAILABLE SYSTEMS

AIR BATH

- Perimeter air channel lined with antimicrobial coating
- Variable-speed, heated-air blower and automated purge-and-dry cycle and water sensors
- Electronic control with wave and pulse features
- Chromatherapy
- Factory run-tested

HOTSOAK

- 2 low-profile circulation portals
- 1.5kW inline maintenance heater
- Quiet, run-dry safe pump
- Electronic one-touch off/on control
- Quiet pad anti-vibration pump mount
- Heatbent rigid PVC piping
- Factory run-tested

DRIFTBATH

- Up to 70 water-only portals
- Quiet 3/4 hp pump with integrated heat
- Electronic control
- 4 high-intensity LED chromatherapy lights
- Available in White or Biscuit



SERENITY 4

59 1/2 x 32 x 24 (1510 x 815 x 610)
inches (mm)



Note: Drop-in Serenity models feature a Pre-leveled ABS Support Base.

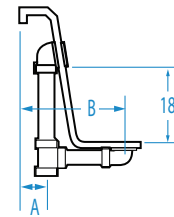
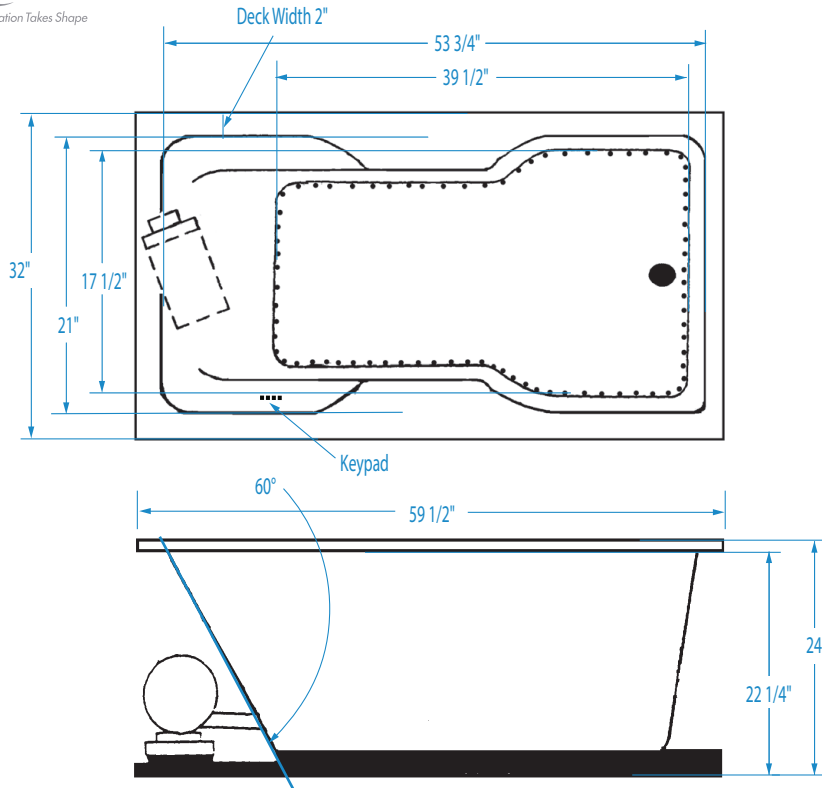

FEATURES lbs (kg) Dimensional Tolerance ± 3/8". Dimensions needed for site preparation should be measured from the unit. Aquatic assumes no responsibility for preparatory work.

Type and Model #	Material	System	Powered By	Heater	Controls	Drain	Pkg. Wt.
Soaker #A14AIR6032TO	Acrylic	-	-	-	-	Universal	179 (81)
HotSoak #A14AIR6032HS	Acrylic	Water circulation	Pump	1.5 kW Inline maintenance	Electronic	Universal	209 (95)
Air Bath #A14AIR6032	Acrylic	Air channel	Variable speed blower	Integrated	Electronic	Universal	209 (95)
DriftBath #A14AIR6032DB	Acrylic	Water circulation	Pump	Integrated	Electronic	Universal	220 (100)

DIMENSIONS inches (mm)

Width Overall / Net	Depth Overall / Net	Height Overall / Net	Skirt Height
59 1/2 (1510)	32 (815)	24 (610)	-

SUMP DATA inches (mm)

Capacity to Overflow gal (ltr)	Min. Operating Capacity gal (ltr)	WIDTH @ centerline		DEPTH @ centerline	
		Top	Bottom	Top	Bottom
65 (246)	-	53 3/4 (1365)	39 1/2 (1005)	21 (535)	17 1/2 (445)

PLUMBING DIMENSIONS inches (mm)

A	B	Drain Diameter / Clearance
2 (50)	10 1/4 (260)	2 (50) / 1 5/8 (40)

ELECTRICAL DATA

Component	Specification	Requirement
Heated Blower (Air Bath)	10.5 AMP; 120V	15 AMP; 120V, separate circuit; Class A GFCI
Pump (HotSoak)	1/15 HP; 1.3 AMP; 120V	20 AMP; 120V, separate circuit; Class A GFCI
Heater (HotSoak)	1.5 kW; 12 AMP; 120V	
Pump (DriftBath)	3/4 HP; 8.8 AMP; 120V	15 AMP; 120V, separate circuit; Class A GFCI

NOTES:

1) Where applicable, utilize cut-out templates packed with unit for deck cutouts.

2) 16 x 16 (405 x 405) minimum access required at pump/blower location(s).

3) For Low Profile Deck, framing height will need to be increased by an additional 1".

4) If a (3T) tiling flange is selected, then the keypad is located opposite of the flange.

Each Serenity air bath is equipped with an air heating system to raise the temperature of the air entering the bath. This air temperature will be lower than the bathing temperature of the water, but will help reduce rapid decrease in water temperature. In addition, the air coming from the air jets will feel cool against the skin. This system does not heat the water.

SERENITY

PUMP/BLOWER LOCATIONS

TECHNICAL SPECIFICATIONS

Air Bath • HotSoak • DriftBath

AIR BATH

Center Drain Models

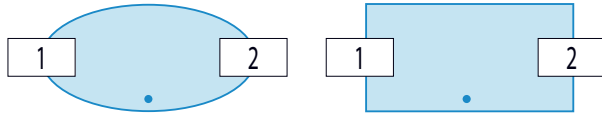

End Drain Models

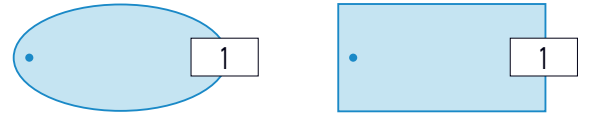

HOTSOAK

Center Drain Models

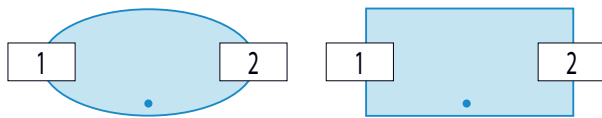

End Drain Models

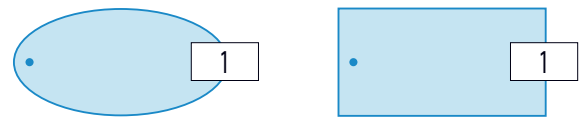

DRIFTBATH

Center Drain Models

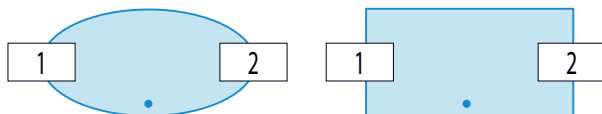

End Drain Models



Center Drain Models

