



AQUATIC

Where Inspiration Takes Shape



INFINITY

OWNER'S MANUAL & INSTALLATION GUIDE

Installer: This booklet must be given to the product owner. Please add important information below.

Model # _____ Purchase Date _____

Serial # _____ Distributor _____

Note: Read all instructions before proceeding with installation.
All specifications are $\pm 1/4''$ and are subject to change without notice. Dimensions listed in inches (mm).



TABLE OF CONTENTS

PRODUCT WARRANTY REGISTRATION INFORMATION	3
IMPORTANT SAFETY INSTRUCTIONS	4
INSTALLATION INSTRUCTIONS	
Pre-Installation Procedures	5 – 6
Structural Preparation	6 – 7
Factory Installed Tile Flange	8
Plumbing	8
Rough-In Measurements	9
Fast Fill Waterfall Spout	9
Electrical Installation	10 – 11
OPERATION INSTRUCTIONS	
Bathside Control Systems	12 – 13
Jet Operations	14 – 15
User Information	16
FCC Consumer Information	16
TUB CARE	
Maintenance	17 – 18
Repair	18
WATER QUALITY ISSUES	19 – 20
TROUBLESHOOTING GUIDE	21
REPLACEMENT PARTS MAPS	22 – 25
REPLACEMENT PARTS LIST	26
AQUATIC LIMITED WARRANTY	27

AQUATIC Product Warranty Registration Information

Thank you for choosing an Aquatic bath. You have chosen one of the finest bath products in the industry. Aquatic supports your purchase with strong commitments to quality and customer satisfaction.

IMPORTANT!

To activate Product Warranty please register with Aquatic. Your product warranty must be registered and confirmed with Aquatic through the Serial Number on your unit. To register, please contact Aquatic.

(800) 945-2726 • www.aquaticbath.com/register

Please read and follow all of the instructions contained in this Owner's Manual before installing, operating or maintaining your whirlpool. In addition, you should continually refer to these instructions during the life of your whirlpool. Failure to comply with these instructions may invalidate your warranty. If you have any questions concerning installation, operation, maintenance or any other aspect of your whirlpool, please contact:

AQUATIC CUSTOMER SERVICE CENTER: (800) 945-2726

(The Troubleshooting Guide on page 21 may be helpful in answering some of your questions.)

NOTE: The installation and service of your whirlpool should be performed **ONLY** by a qualified electrician and plumber.

IMPORTANT!

This product **MUST BE WATER-TESTED** and inspected prior to installation or warranty will be voided. [See **INSPECTION BEFORE INSTALLATION** on page 5.] Neither Aquatic nor the distributor will be responsible for removal or reinstallation costs should replacement of the bath be necessary.

PLEASE CHECK ENTIRE UNIT FOR ANY DAMAGE.

If it appears damaged, contact your Aquatic Distributor immediately. Aquatic warranty does not cover damage that occurs in transit.



AQUATIC

Where Inspiration Takes Shape

8101 E. Kaiser Blvd., Suite 200 • Anaheim, CA 92808
(800) 945-2726 • Fax (866) 544-5353
www.aquaticbath.com

IMPORTANT SAFETY INSTRUCTIONS

WARNING: WHEN USING THIS UNIT, THESE BASIC PRECAUTIONS SHOULD BE FOLLOWED.

This manual contains information and instructions for proper operation and maintenance of your whirlpool. Failure to follow these instructions could result in personal injury, electrical shock or fire.

READ AND FOLLOW ALL INSTRUCTIONS

DANGER! TO REDUCE THE RISK OF INJURY:

- A. Do not permit children to use this unit unless they are closely supervised by an adult at all times. Supervision is also required when whirlpool bath is used by an elderly or handicapped individual.
- B. Use this unit only for its intended use as described in this manual. Do not use attachments not recommended by the manufacturer.
- C. Do not operate this unit without guard over the suction fitting.
- D. The water in a whirlpool should never exceed 40°C (104°F). Water temperatures between 38°C (100°F) and 40°C (104°F) are considered safe for a healthy adult. Use time should be limited to approximately 30 minutes, followed by a shower to cool down. Longer exposures may result in hyperthermia. The symptoms of this condition are nausea, dizziness and fainting, which can be fatal. Lower water temperatures are recommended for extended use (exceeding 10-15 minutes) and for young children.
- E. Since excessive water temperatures have a high potential for causing fetal damage during the early months of pregnancy, pregnant or possibly pregnant women should limit whirlpool water temperatures to 38°C (100°F).
- F. The use of drugs or alcoholic beverages before or during whirlpool use may lead to unconsciousness with the possibility of drowning. Never use the whirlpool while under the influence of alcohol, anticoagulants, stimulants, antihistamines, vasoconstrictors, vasodilators, hypnotics, narcotics or tranquilizers.
- G. Persons with a medical history of heart disease, low or high blood pressure, circulatory system problems, or diabetes should consult a physician before using a whirlpool.
- H. Persons using medication should consult a physician before using a whirlpool since medication may induce drowsiness while other medication may affect heart rate, blood pressure and circulation.

DANGER: To reduce the risk of injury, enter and exit the bath slowly.

WARNING: Never operate electrical devices in or near the bath. Never drop or insert any object into any opening within the whirlpool.

This unit must be connected to a supply circuit that is protected by a Ground Fault Circuit Interrupter (GFCI). Such a device should be installed by a licensed electrician and should be tested on a regular basis (at least monthly). To test the GFCI push the TEST button. The GFCI should interrupt the power. Push the RESET button and the power should be restored. If the GFCI fails to operate in this manner there is the possibility of an electric shock. **DO NOT USE.** Disconnect the unit and have the problem corrected by a qualified service technician. To avoid the possibility of personal injury and discoloration of the acrylic surface, the inlet water temperature should not exceed 60°C (140°F). The bath should be drained after each use. Each bather should start their bath with fresh water.

CAUTION: DO NOT USE HARSH ABRASIVES OR SOLVENTS FOR CLEANING THIS UNIT.

INSTALLER/OWNER BEARS ALL RESPONSIBILITY TO COMPLY WITH ALL STATE AND LOCAL CODES WHEN INSTALLING THIS PRODUCT.

SAVE THESE INSTRUCTIONS

INSTALLATION INSTRUCTIONS

READ ALL INSTRUCTIONS CAREFULLY BEFORE INSTALLATION

PRE-INSTALLATION PROCEDURES

PLEASE NOTE: THE MANUFACTURER ACCEPTS A $\pm 3/8$ " VARIANCE. THERE ARE VARIATIONS ON EACH TUB AND SPECIFICATIONS ARE SUBJECT TO CHANGE AS WE IMPROVE UPON OUR PRODUCT AS REQUIRED.

THE DIMENSIONS NEEDED FOR SITE PREPARATION AND STRUCTURE BUILDINGS SHOULD BE MEASURED FROM THE TUB; AQUATIC ASSUMES NO RESPONSIBILITY FOR PREPARATORY WORK.

Note: A good knowledge of construction techniques, plumbing and electrical installation according to codes are required for proper installation. We recommend that a qualified licensed contractor perform the installation of all Aquatic products. Our warranty does not cover improper installation related problems.

1. Immediately upon receiving your Aquatic whirlpool bath inspect it thoroughly for freight damage. If necessary, contact your dealer/distributor immediately (your dealer/distributor must contact Aquatic, Inc. within 24 hours of receiving unit to file a claim.) Should inspection indicate any damage, do not install the bath.
2. All baths are filled with water and operated in our manufacturing facility prior to shipment. Inspectors ensure watertight operation, however, rough handling may cause leaks which may be detected prior to installation.

Damage or defect to the finish claimed after the bath is installed is not covered under the warranty.

To Inspect:

1. Place the tub in an area where it may be drained after testing.
2. Fill the tub with hot water (approximately 100° F) to the overflow and allow to stand for a few minutes. Carefully inspect all fittings and connections for leaks.
3. Plug in pump and blower cords and run pump for 10 minutes.
4. With the pump running, turn on the blower. Check all functions.
5. Inspect the tub completely. Any defect must be reported to Aquatic prior to installation in order to have it covered by warranty. **Should inspection indicate any damage, do not install the bath.**
6. Check to ensure that your installation will conform to all applicable codes and secure necessary permits. All electrical and plumbing connections should be made by qualified electricians and plumbers.

Damage or leaks claimed after the bath is installed are not covered under the warranty.

WARNING: failure to follow these instructions during installation will result in termination of the warranty: Do not lift the tub by any portion of the plumbing or pump. Do not stand in the tub during construction.

DO NOT MAKE ANY ALTERATIONS, ADDITIONS, OR DELETIONS TO THE WHIRLPOOL SYSTEM PUMP OR BATH.

WARNING: Whirlpool pump and piping are factory assembled. Relocation of pump or other modifications could adversely affect the performance and safe operation of this whirlpool. Aquatic shall not be liable under its warranty or otherwise for personal injury or damage caused by any such unauthorized modification.

INSTALLATION INSTRUCTIONS

QUIETNESS OF OPERATION: Aquatic has engineered their whirlpool baths from base to lip to ensure quality, value, functional design, and maximum bathing comfort. However, installation is accountable for as much as 50% of a tub's operating quietness. Please ensure the following:

- The floor structure is adequate to support the installation.
- For quieter operation and heat retention conservation, the walls surrounding the whirlpool may be insulated.
- Insulate the tub surround. Do not allow any insulation to come within 3 feet of the pump. The area around the pump must be clean and free of any foreign matter.
- Leave 1/8" to 3/16" gap between tub lip and surround.

STRUCTURAL PREPARATION

NOTE: The bath should remain in its shipping carton until time of installation.

1. Literature dimensions are for reference only. Installation dimensions should be taken directly from the tub. An access panel of 20" x 18" minimum must be provided at the pump end of the whirlpool allowing sufficient clearance to make final connections and for servicing the pump and power panel. An additional access of 16" x 16" minimum must also be provided for the blower motor and control box. Access may be through the wall or platform apron at the end of the unit. In the case of sunken installations, access should be made through the ceiling below.

It is the installer's responsibility to provide sufficient service access. Make absolutely certain that access panels and/or service openings are properly placed and that all possible areas where service may be required are accessible.

2. Install the drain fitting to the bath. Clearance may be needed for the drain by cutting away the subfloor (where possible) or by blocking below the tub as may be required.
WARNING: FACTORY SKIRTS DO NOT ALLOW FOR BLOCKING UP OF THE TUB BASE. All blocking must be solid and provide uniform support to the tub base.
3. Tub must rest entirely on all leveling feet. **DO NOT SUPPORT THE WEIGHT OF THE TUB BY THE RIM.** Lift unit and place into framework. If necessary, adjust feet until unit is completely touching on the leveled sub floor. Secure the unit by fastening the bottom feet to the sub floor with any construction adhesive caulk. For quieter operation and heat conservation, the walls surrounding the whirlpool may be insulated.
4. Frame out under the tub rim as shown in one of the illustrations below. **NOTE:** Due to the variety of installations possible, framing procedures other than those described may be required. Plumb in selected location using a level. Level front to back and across both sides. A ledge under the rim, or an apron without a ledge, may be constructed as required (see Diagram 1A, 1B and 1C). Where installation will be against a wall, stud wall framing should allow for wall sheathing material to run full length to the floor (see Diagram 1D). Install tub firmly against sheathing as indicated, with blocking below rim to prevent deflection or movement of tub. To prevent a rocking movement of tub after installation, it is important to have rim in contact, but not supported by blocking material.

NOTE: Watertight installation of the drain and over flow is the installer's responsibility. Drain and/or overflow leakage is not included in the warranty of this product.

INSTALLATION INSTRUCTIONS

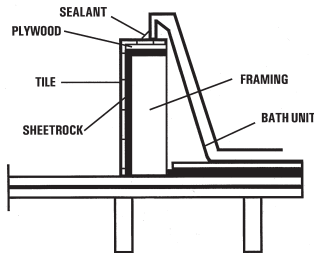

1A Ledge Installation - 1

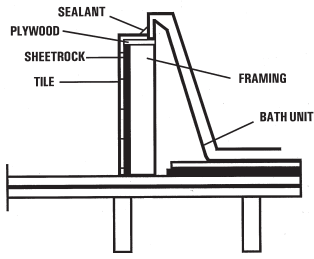

1B Ledge Installation - 2

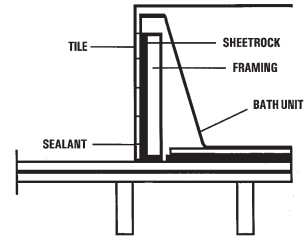

1C Apron Installation

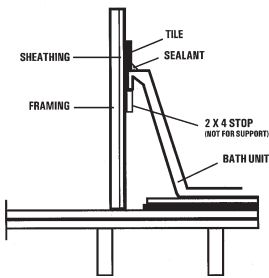

1D Wall Installation

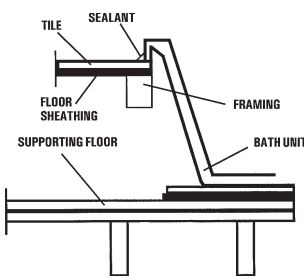

1E Sunken Installation

WARNING: ALL ELECTRICAL CONNECTIONS SHOULD BE MADE BY A LOCALLY LICENSED ELECTRICIAN.

- When placing the tub on a platform or cut out (see Diagrams), the opening should be 1" smaller than the specified rim dimensions. Extreme care must be taken in this type of installation to ensure the tub will come to rest entirely on the leveling feet.
- IF YOU HAVE PURCHASED A WHIRLPOOL WITH AN INSTALLED TILE FLANGE, PROCEED TO INSTRUCTION "2A".

INSTALLATION INSTRUCTIONS

FACTORY INSTALLED TILE FLANGE

SEE ILLUSTRATION 2A

- a. Install the whirlpool bath unit per the instructions provided in this manual.
CAUTION: THE TILE FLANGE DOES NOT SUPPORT THE TUB! A ledger board must be provided under the bath rim as indicated in the installation instructions. Take care to ensure tub is not hanging from the ledger boards, as this will void your warranty.
- b. Use nails or screws to secure the flange into the studs around the bath.
- c. Install water resistant drywall against the tile flange and flush to the top of the whirlpool deck. Install the tile or other finishing materials. Apply a second bead of silicone between the first course of tile and the bath deck.

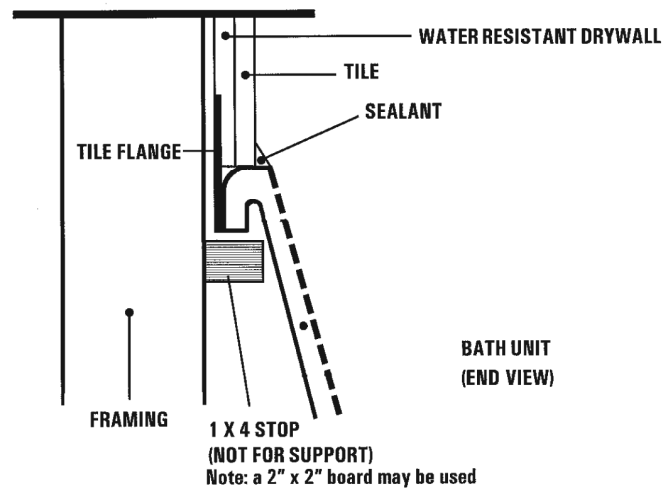

2A

NOTE: Before tub is used, the whirlpool system should be cleaned in accordance with the procedures on Page 22 of this manual.

PLUMBING

1. After securing tub in place, normal waste and overflow valves (3/4" valves are recommended) are installed per normal plumbing procedures, in accordance with all state and local standards.
2. Install standard 1-1/2" trap to drain and overflow. Before proceeding, make a final operational check by filling tub with water to overflow and operate pump for 5 minutes. Check for leaks carefully both while pump is running and has been turned off. Allow water to stand in tub for at least 30 minutes before draining. Aquatic WILL NOT BE RESPONSIBLE FOR WATER DAMAGE OF ANY KIND IN CONNECTION WITH ONE OF OUR WHIRLPOOL BATHS.
3. All Infinity Series models are equipped with an integral Fast Fill Waterfall Spout. Purchasing a spout is unnecessary, however, hot and cold water valves are needed. Valves can be mounted where you choose, however, if installation is to be on the tub deck, check the back side of the tub for adequate space for connection to water lines before drilling or cutting tub.

INSTALLATION INSTRUCTIONS

ROUGH-IN MEASUREMENTS

See Diagram 3A, below

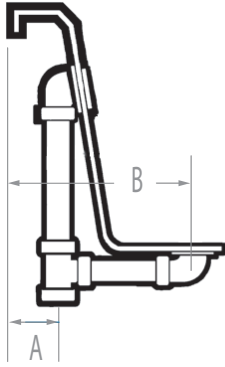

3A

MODEL

- Infinity 2
- Infinity 4
- Infinity 5
- Infinity 6
- Infinity 7
- Infinity 9

A

(From center of overflow pipe to outside rim)

- 2 3/8"
- 3"
- 3 1/2"
- 5"
- 4"
- 2 1/2"

B

(From center of drain to tub rim)

- 9 1/2"
- 11 3/4"
- 11"
- 10 1/2"
- 10"
- 8 3/4"

PLEASE NOTE: THE MANUFACTURER ACCEPTS A 1/4" VARIANCE. THERE ARE VARIATIONS ON EACH TUB AND SPECIFICATIONS ARE SUBJECT TO CHANGE AS WE IMPROVE UPON OUR PRODUCT AS REQUIRED.

THE DIMENSIONS NEEDED FOR SITE PREPARATION AND STRUCTURE BUILDING WILL DIFFER; AQUATIC ASSUMES NO RESPONSIBILITY FOR PREPARATORY WORK.

FAST FILL WATERFALL SPOUT

Your Fast Fill Waterfall Spout will be stubbed as in Diagram 3B.

3B



FROM VALVES

Fast Fill Waterfall Spout is stubbed out with a 3/4" female threaded Brass fitting.

See Diagram 3C for connecting the hot and cold valves.

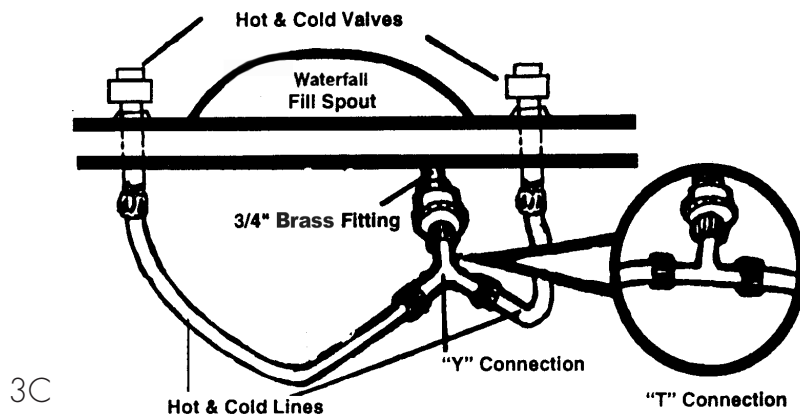

3C

CAUTION:

Do not overtighten. Do not use Teflon Tape.

INSTALLATION INSTRUCTIONS

ELECTRICAL INSTALLATION

WARNING: ALL ELECTRICAL CONNECTIONS SHOULD BE MADE BY A LICENSED, LOCALLY CERTIFIED ELECTRICIAN, IN ACCORDANCE WITH THE REQUIREMENTS OF THE NATIONAL ELECTRICAL CODES AND PROCEDURES.

WARNING: WHEN USING ELECTRICAL PRODUCTS, PRECAUTIONS SHOULD ALWAYS BE FOLLOWED, INCLUDING THE FOLLOWING:

DANGER: RISK OF ELECTRIC SHOCK!

GFCI's are not supplied, however we do specify their use.
All known code authorities require GFCI's.

Infinity baths will need to be hard wired to the outlets provided. See the following directions and diagram.

Two junction boxes will be mounted to the frame of the whirlpool. One of the two boxes will have one outlet and will be labeled "Blower". Remove the cover and connect a 14/2 with ground Romex wire from a 15 amp 1-pole GFCI breaker (not supplied) in the main circuit breaker panel. Connect the black wire to the hot side of the receptacle, the white wire to the neutral side of the receptacle and the green wire to ground. Replace the cover and plug in the blower. (See diagram on page 11).

The second junction box will have two outlets, one labeled "Main" and the other labeled "Heater". Remove the cover. Run Romex 14/3 with ground from a 15 amp 2-pole GFCI breaker (not supplied) located in the breaker panel. Connect the white wire (neutral) to both neutrals of the two outlets. Connect the red wire (hot) to the hot terminal of the outlet labeled "Main". Connect the black wire (hot) to the hot terminal of the other outlet labeled "Heater". Connect the green wire (ground) to the ground terminal of the outlet. Replace the cover of the junction box. Find the cord labeled "Heater AC Input" and plug it into the outlet labeled "Heater". Plug the cord labeled "Main AC Input" into the outlet labeled "Main". Both of these cords will come from the right side of the heater and will be marked. (See diagram on page 11).

CAUTION: Before use of the pump and heater, test the GFCI for proper operation. The pump and heater should turn off when the GFCI "Test" button is pushed.

WARNING - Prolonged Immersions in Hotter Water May Induce Hyperthermia.

Hyperthermia occurs when the internal temperature of the body reaches a level several degrees above the normal body temperature of 98.6°F. The symptoms of hyperthermia include an increase in the internal temperature of the body, dizziness, lethargy, drowsiness, and fainting. The effects of hyperthermia include (1) failure to perceive heat, (2) failure to recognize the need to exit the whirlpool, (3) unawareness of impending hazard, (4) fetal damage in pregnant women, (5) physical inability to exit the whirlpool, (6) unconsciousness resulting in the danger of drowning.

WARNING - The use of alcohol, drugs, or medication can greatly increase the risk of fatal hyperthermia.

TO REPLACE THE LED LIGHT

1. Disconnect the power to your bathtub.
2. Drain the bathtub.
3. Open the lens of the fixture using ONLY the proper tool provided for that purpose. Do not attempt to remove the lens without the provided tool.
4. Replace your LED light (replacement LED lights can be obtained from Aquatic).

NOTE: Do not twist LED light into socket. Use gentle pressure and push LED light into place.



INSTALLATION INSTRUCTIONS

ELECTRICAL INSTALLATION (CONTINUED)

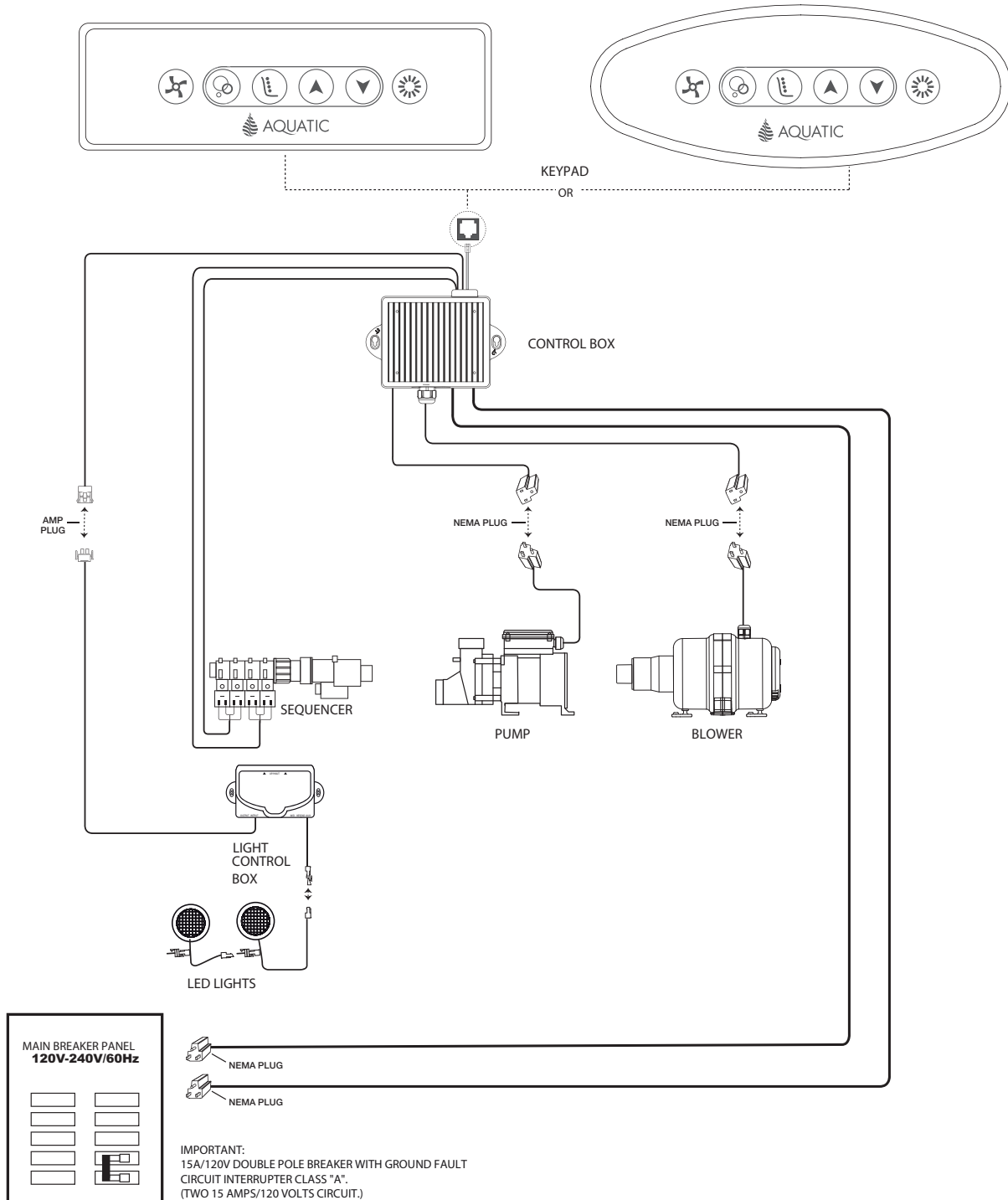

BONDING WIRE: Connect a #8 bare copper bonding wire from the pump motor to the heater and then to the cold water plumbing or other suitable ground. Grounding is required. Grounding is NOT required for the blower.

OPERATION INSTRUCTIONS

NOTE: DO NOT START PUMP UNTIL ALL JETS ARE SUBMERGED. WATER LEVEL SHOULD BE 2" ABOVE HIGHEST JET.

BATHSIDE CONTROL SYSTEMS

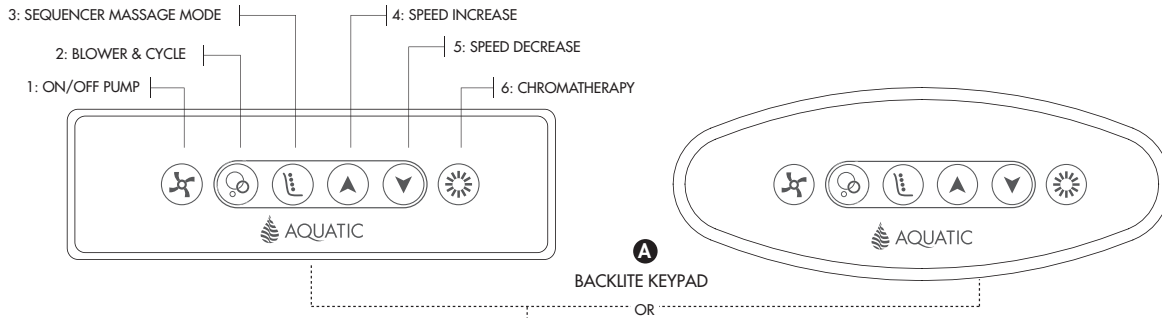

KeyPad A Functions	LED
1: ON/OFF PUMP	
1st Press: The pump starts	ON
2nd Press: The pump stops	OFF
2: BLOWER & CYCLE	
1st Press: Blower starts at high speed.	ON
2nd Press: Wave Cycle - Speed goes gradually from maximum to minimum.	BLINKS
3rd Press: Blower stops	OFF
3: SEQUENCER MASSAGE MODE	
1st Press: Massage Mode A Starts.	ON
2nd Press: Massage Mode B Starts.	BLINKS TWICE follows the speed of the valve
3rd Press: Massage Mode C Starts.	BLINKS 3 TIMES follows the speed of the valve
4th Press: Massage Mode D Starts.	BLINKS 4 TIMES follows the speed of the valve
5th Press: Massage Mode Stops.	OFF
4: SPEED INCREASE	
When the blower is on without the sequencer, press and hold to increase the blower speed. Release pressure at the desired speed. When the sequencer is on, press to increase the speed at which the sequencer operates. Release pressure at the desired speed.	ON When Pressed
5: SPEED DECREASE	
When the blower is on without the sequencer, press and hold to decrease the blower speed. Release pressure at the desired speed. When the sequencer is on, press to decrease the speed at which the sequencer operates. Release pressure at the desired speed.	ON When Pressed
6: CHROMATHERAPY	
1st Press: Turn on the light in white	ON
2nd Press: Rainbow cycle - Low speed	ON
3rd Press: Rainbow cycle - High speed	ON
4th Press: Turquoise	ON
5th Press: Blue	ON
6th Press: Magenta	ON
7th Press: Red	ON
8th Press: Orange	ON
9th Press: Yellow	ON
10th Press: Green	ON
11th Press: Turn off the light <i>Press and hold 2 sec. at anytime to turn off the chromatherapy</i>	OFF

Advanced Programming

INTEGRATED 20 MINUTE AUTOMATIC TIMER

Integrated 20 minute automatic timer on the complete system. Count down starts with the last system turned on. Blower LED will blink until the purge occurs except during the first minute.

DRYING CYCLE

A 1 minute automatic drying cycle will start 20 minutes after the blower is turned off. The blower LED button blinks while waiting for the purge cycle.

OPERATION INSTRUCTIONS

BATHSIDE CONTROL SYSTEMS

KeyPad A Functions

SEQUENCER MODE A

The Backjet row shown will be at ON during the cycle:
Backjet row 1, 2, 3, 4, 3, 2 and repeats the sequence.

SEQUENCER MODE B

The Backjet row shown will be at ON during the cycle:
Backjet row 1-2-1-2 All Off, 1-2-1-2 All Off.

SEQUENCER MODE C

The Backjet row shown will be at ON during the cycle:
Backjet row 3-4-3-4 Off, 3-4-3-4 All Off.

SEQUENCER MODE D

The Backjet row shown will be at ON during the cycle:
Backjet row All On, All Off.

Advanced Programming

PRESETS

This mode allows the user to start the tub with his preferred settings with the pres of a button. Up to 4 different presets can be configured.

To Configure the Settings:

- Start all desired systems
- Adjust the blower/sequencer speed and the light color
- Press button 1 for more than 1 second.
- LED's 2, 3, 4 and 5 will blink. You have 10 seconds to choose which of the 4 buttons you want your settings saved to.
- Press the selected button
- LED's of the selected button will blink 3 times to confirm.
- All systems will stop.

To Select a Preset:

- When all accessories are turned off, press the selected button more than 1 second.
- The preselected settings will activate.

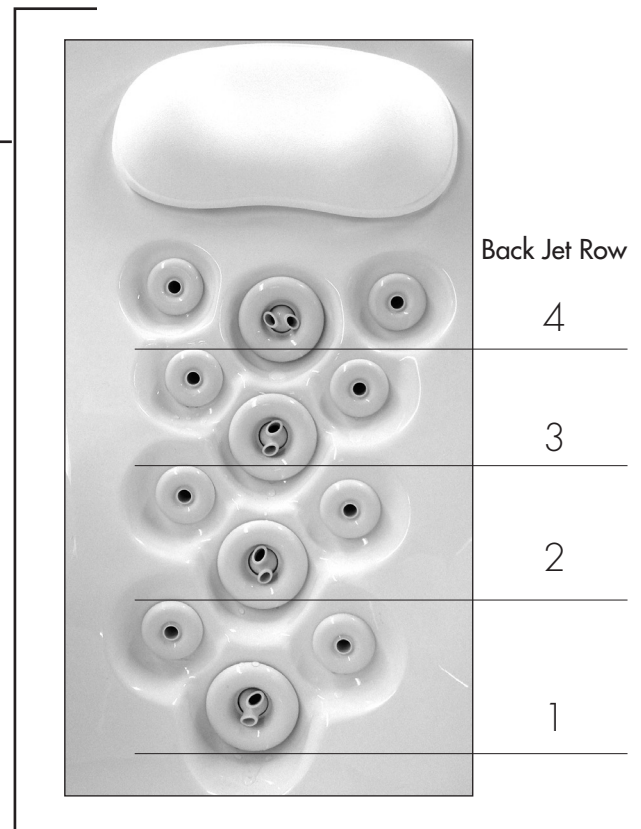

OPERATION INSTRUCTIONS

JET OPERATIONS

All Infinity Series jets are removable and can simply be put into the dishwasher for cleaning.

Note: Use dishwasher top rack and remove before the drying cycle starts.

The Infinity Series features Aquatic's exclusive Shiatsu Back Jetting System, Pressure Plus Jets and Pressure-Flo Hydrotherapy Jets.

Shiatsu Back Jetting System

To adjust pressure (see Diagram 4A):

1. Grasp the outer ring of the jet.
2. Turn the jet clockwise to increase flow, counter-clockwise to shut off.

To remove jet (see Diagram 4B):

1. Grasp the outer ring of the jet.
2. Turn the jet counter-clockwise, until the jet clicks, then pull.

To replace or change jet (see Diagram 4B):

1. Insert the jet into jet housing.
2. Turn the jet clockwise, past point of resistance, until the jet clicks.

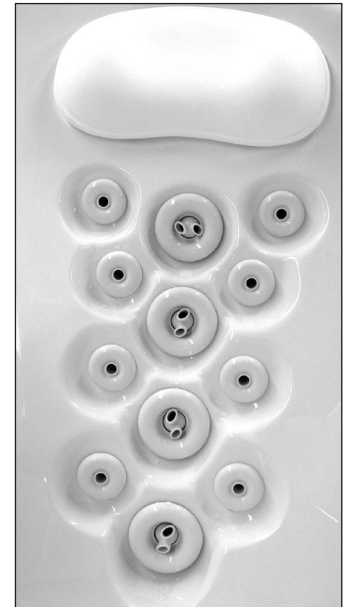

4A



4B

OPERATION INSTRUCTIONS

Pressure Plus Jets

To adjust pressure (see Diagram 5A):

1. Grasp the outer ring of the jet.
2. Turn the jet clockwise to increase flow, counter-clockwise to shut off.

To remove jet (see Diagram 5B):

1. Grasp the outer ring of the jet.
2. Turn the jet counter-clockwise, until the jet clicks, then pull.

To replace or change jet (see Diagram 5B):

1. Insert the jet into jet housing.
2. Turn the jet clockwise, past point of resistance, until the jet clicks.



5A



5B

Pressure-Flo Hydrotherapy Jets

For customized hydrotherapy, simply adjust volume of the Pressure-Flo Jet by turning counter clockwise for a gentle flow of air and water or clockwise for stronger massage action. Recessed for greater comfort, the Pressure-Flo Jet targets the hip and leg areas.

To adjust pressure (see Diagram 6A):

1. Grasp the outer ring of the jet.
2. Turn the jet clockwise to increase flow, counter-clockwise to shut off.

To adjust direction (see Diagram 6B):

1. Using fingertip, move jet eye to desired location.

To remove jet (see Diagram 6C):

1. Grasp the outer ring of the jet.
2. Turn the jet counter-clockwise, until the jet clicks, then pull.

To replace or change jet (see Diagram 6C):

1. Insert the jet into jet housing.
2. Turn the jet clockwise, past point of resistance, until the jet clicks.



6A



6B



6C

WHIRLPOOL USER INFORMATION

PLEASE NOTE:

The whirlpool action may cause even small amounts of bubble bath or shampoo to foam excessively. Exercise moderation in experimenting with different soap products.

No servicing of this product should be done by the user. There are no user serviceable parts. All controls are located in the control recesses on the lip of the tub. These are the only controls that should be used by the consumer. Do not change or alter any of these controls under any circumstances.

Motors are self-lubricating - No lubrication required.

FCC CONSUMER INFORMATION

Electrical Installation Information Listed on pages 10-11.

This equipment generates and uses radio frequency energy and if not installed and used properly, that is, in strict accordance with the manufacturers instruction, may cause interference to radio and television reception. It has been type tested and found to comply with the limits for a class B computing device in accordance with the specifications in subpart J of part 15 of the FCC rules, which are designed to provide reasonable protection against such interference in a residential installation. However, there is no guarantee that interference will not occur in a particular installation. If this equipment does cause interference, which can be determined by turning the equipment on and off, the user is encouraged to try to correct the interference by one or more of the following measures:

- Reorient the receiving antenna.
- Relocate the receiver with respect to the bath tub.
- Move the receiver away from the bath.
- Plug the receiver into a different outlet so that the receiver and bath are on different branch circuits.
- If necessary, the user should consult the dealer or an experienced radio/television technician for additional suggestions.
- The user may find the following booklet prepared by the FCC helpful: "How To Identify and Resolve Radio-TV Interference Problems." It is available from the U.S. Government Printing Office, Washington, DC 20402, Stock No., 004-000-00345-4.

Serial Number Location

The tub model and serial number is located above the pump area on the backside of the bathtub. Your installer should have a service access panel in this location.



TUB CARE

MAINTENANCE

Before tub is used, the whirlpool system should be cleaned and disinfected. Remove all debris and clean tub before putting whirlpool into service. **DO NOT USE ABRASIVE CLEANERS ON THE ACRYLIC FINISH.** Use a non-abrasive detergent and rinse well after cleaning.

- Fill the tub with HOT water to a level 2" above the highest jet.
- Add 2 teaspoons of low-sudsing automatic dishwashing detergent and no more than 4 ounces of household bleach to the water.
- Operate whirlpool for 10 minutes. Drain. Note: To effectively clean both the whirlpool and air bath system, you must operate them both.
- Refill with cold water and operate whirlpool for 5 minutes. Drain.

Whirlpool System Cleaning:

To remove accumulations of bath residue from the whirlpool system, we recommend that you purge it at least twice a month, or more depending on usage. To do this, follow this simple procedure. Fill the bath with hot water (not exceeding 104° F). Add to the hot water, 4 (6) tablespoons of low foaming detergent such as liquid Cascade or Calgonite and 24 (48) oz. of liquid household bleach, such as Clorox [use lesser amounts shown for 5-foot bathtubs, greater amounts in parentheses for larger bathtubs]. Run the bath for 5 to 10 minutes. Drain the bath completely and refill with cold water only. Run the whirlpool for 5 to 10 minutes, then drain the bath completely. Depending on the usage and/or the content of the local water supply, more frequent purging may be necessary.

Air Bath System Cleaning:

NOTE: DO NOT TURN THE PUMP ON DURING THE AIR BATH CLEANING.

Before tub is used, your air bath and plumbing system should be flushed. Close the drain. Fill bath with hot water to at least six inches above air injector holes. Add 2 teaspoons of low sudsing automatic dishwashing detergent and no more than 4 ounces of bleach to the water. **DO NOT** use bleach or other chlorinated cleansers on metal trim surrounding control panels. Turn blower on for approximately two minutes to mix cleaner with water. Shut blower down and allow cleaner to soak in the bath for approximately two hours. Turn ON air bath and run for approximately five minutes. Turn air bath unit OFF and drain tub. Aquatic recommends the above cleaning process on your air bath system once a month.

NOTE: DO NOT USE OIL OR OIL BASED BATH ADDITIVES.

If you want to use any kind of bath additive, use only a small amount of low-foaming powder or crystal substance; the whirlpool action intensifies the foaming properties of soaps.

The use of certain bubble baths and bath additives may increase the level of accumulations of bath residue in the whirlpool system. If excess accumulations persist, you should discontinue use of these products.

If you have followed the monthly purging instructions and still have an excess accumulation of bath residue and desire an alternative cleaning mechanism, we recommend SUPER SYSTEMS CLEAN PLUS manufactured by Stearns Packaging Corporation to rectify this condition. This may be obtained by calling Aquatic, at (800) 945-2726. It is recommended that you follow the instructions provided by the manufacturer with the product. Repeated use may be necessary. SUPER SYSTEMS CLEAN PLUS does not replace the necessity to purge your whirlpool system at least twice a month with a low foaming detergent and bleach.

TUB CARE

MAINTENANCE (CONT.)

Surface Cleaning

Use common household, non-abrasive cleaners for most cleaning jobs. Rinse well and dry with a clean cloth. Never use abrasive cleaners. Do not allow your Lucite® acrylic surface to come into contact with products such as acetone (nail polish remover), nail polish, dry cleaning solution, lacquer thinners, gasoline, pine oil, etc. Remove dust with a soft, dry cloth. Clean grease, oil, paint, and ink stains with isopropyl (rubbing) alcohol.

Jet Cleaning:

All Infinity Series jets are removable, and can simply be put into the dishwasher for easy cleaning. See Jet Operation Instructions for removal, pages 14-15. (Note: Use top rack of dishwasher and remove before the drying cycle starts.)

Surface Scratch Removal

Minor scratches may be removed by polishing your tub with a non-abrasive car polish, followed by buffing. Deeper scratches can be removed by:

- Sanding with wet 400 grit sandpaper.
- Sanding with wet 600 grit sandpaper.
- Sanding with wet micro-grit sandpaper.
- Buff out using car polish.

REPAIR

The service of your whirlpool bath should be performed only by a qualified service technician. Remember when contacting your dealer always have your serial number, proof of purchase and model number available. This will ensure a quick response on warranty items.

The model and serial numbers are located above the pump on the backside of the whirlpool.

NOTE: ALL WARRANTY REPAIRS MUST BE AUTHORIZED BY AQUATIC BEFORE WORK IS STARTED. FOR SERVICE, ALWAYS CONTACT YOUR DEALER.

CAUTION: Care should be taken to prevent inappropriate chemicals coming in contact with the Lucite® acrylic surface. Please read and observe all instructions and/or warnings on containers containing substances you contemplate applying to your whirlpool. Any failure to comply may void your warranty.

WATER QUALITY

CHEMICAL & WATER QUALITY

Owners of fill and drain air bathtubs need to know basic information concerning water quality, how it affects the performance and enjoyment of the operation of their tubs, and steps that can be taken by the owner to correct related problems. Important issues are the microbiological and chemical quality of the water.

1. Microbiological Quality

Microbes are present in water supplied by individual wells or water systems and even in the air around us. These microbes are usually in amounts below what is noticeable. Microbes from the water or air or from a bather's body may settle on wet surfaces such as a bathtub surface or piping system where they can grow in numbers. With regards to air tubs, brown/black fungi/mold or pigmented (colored) bacteria can be noted.

Fungi/Mold - Fungi and mold are always present. Usually the levels are such that we don't notice them. When moisture and temperature are sufficient, the organisms will grow to levels that we may smell and/or see. The best examples of such growth is the very common black growth on the bottom of shower curtains. The best solution to keep these surfaces free from the growth is frequent cleaning.

Pigmented Bacteria - A pinkish substance may appear on bathroom fixtures that is very persistent, appearing in the shower, sink and along the water line of toilet bowls. The residue is less likely a problem associated with water quality than with naturally occurring airborne bacteria. The bacteria may produce a pinkish film, and sometimes a dark gray film, on surfaces that are regularly moist, including toilet bowls, shower heads, sink drains, and tiles. The problem is more common in humid areas of the country. In any particular case, the determination of the exact species of bacteria causing the problem would require lengthy and costly laboratory testing; however, most experts believe the bacteria responsible is *Serratia marcescens*. These bacteria thrive on moisture, dust and phosphates, and are widely distributed in soil, food and also in animals. The best solution to keep these surfaces free from the bacterial film is continual cleaning. A chlorine containing compound is the best cleaner. Avoid abrasives to limit scratching fixtures, which will make them even more susceptible to bacteria.

2. Chemical Quality

The water supplied by individual wells or water systems always contains chemicals, usually in amounts below those which the consumer would notice. Examples of such chemicals, which are of potential concern for the owners of fill and drain air bathtubs, are calcium and magnesium salts, copper, iron, manganese and sulfates. When these chemicals are present in sufficient amounts, they may cause problems in air bathtubs. You should contact your water supply or treatment company and follow their suggestions for treatment.

Calcium and Magnesium Salts - Collectively, the various compounds of calcium and/or magnesium are referred to as salts. Calcium and magnesium salts are often found in ground water supplies and cause "hardness" in water. Hard and soft water are relative terms. Hard water retards the cleaning action of soaps and detergents, causing expense in the form of extra work and cleaning agents. When hard water is heated, it will deposit a hard scale. With regard to air bathtubs, high calcium and/or magnesium levels may result in the formation of white stains and scale formation on the inside of the tubs, especially noticeable with colored tubs. If this occurs, you need to contact the water supplier to determine the calcium and/or magnesium content and/or corrosion potential of the water and follow their suggestions for treatment. If you are on an individual well, you need to contact a water treatment company to test your water and suggest solutions if a problem is present.

Iron - Iron is found in many natural waters especially from wells. Iron in water can also result from the corrosion of piping in the water supply system, such as cast iron mains or galvanized steel service lines, or galvanized piping in the home water system. High iron levels may result in the formation of brown stains in the vicinity of the faucet outlets of various fixtures in the home. With air bathtubs, the staining may be particularly pronounced because the aeration

WATER QUALITY

action can oxidize iron to a form that settles out on the inside of the tubs, especially noticeable with white tubs. If high iron in the water is present, you can also notice rust colored deposits inside your toilet tank or dishwasher. If this occurs, you need to contact the water supplier to determine the iron content and/or corrosion potential of the water and follow their suggestions for treatment. If you are on an individual well you need to contact the water treatment company to test your water and suggest solutions if a problem is present.

Manganese - Manganese is found in many natural waters especially from wells. High manganese levels may result in the formation of small black particles that can stain laundry, especially noticeable with whites such as sheets or towels. With air bathtubs, the formation of small black particles may be particularly pronounced because the aeration action in the tub can oxidize manganese to an insoluble form that is especially noticeable with white tubs. If high manganese in the water is present, you may also notice black stains on white laundry. If this occurs, you need to contact the water supplier to determine the manganese content of the water and follow their suggestions for treatment. If you are on an individual well, you need to contact a water treatment company to test your water and suggest solutions if a problem is present.

3. Treatment

If you have contacted your water supplier and followed their instructions and you are still having problems, you need to increase the frequency of applications of low-foaming detergent/bleach starting from monthly purging down to using it every other day as required to eliminate your particular problem. The use of certain bath oils, bubble bath soaps and bath additives may increase the level of accumulations of bath residue in the air system. More frequent cleaning may be necessary if these products are used in the air tub. If excess accumulations persist, you should discontinue the use of these products. If you have followed the monthly purging instructions and still have an excess accumulation of bath residue and desire an alternative cleaning mechanism, we recommend **SUPER SYSTEMS CLEAN PLUS** manufactured by Stearns Packaging Corporation to rectify this condition. This may be obtained by contacting Aquatic at (800) 945-2726. It is recommended that you follow the instructions provided by the manufacturer with the product. Repeated use may be necessary. **SUPER SYSTEMS CLEAN PLUS** does not replace the necessity to purge your air system at least once a month with a low foaming detergent and bleach.

TROUBLESHOOTING GUIDE

WARNING: Always turn off power at the main electrical service panel when servicing your whirlpool.

SYMPTOMS	POSSIBLE PROBLEMS	SUGGESTED SOLUTIONS
Motor does not start	<ol style="list-style-type: none"> 1) GFCI or circuit breaker in OFF position. 2) Fuses blown or thermal overload open. 3) Locked motor shaft. 4) Motor windings burned out. 5) Defective starting switch inside single-phase motor. 6) Disconnected or defective wiring. 7) Low voltage. 	<ol style="list-style-type: none"> 1) Reset GFCI. 2) Contact your electrician. 3) Contact Aquatic 4) Contact Aquatic 5) Contact Aquatic 6) Check and reconnect if needed. 7) Contact your electrician.
Motor does not reach full speed	<ol style="list-style-type: none"> 1) Low voltage. 2) Wiring too small. 	<ol style="list-style-type: none"> 1) Contact your electrician. 2) Contact your electrician.
Low pump pressure	<ol style="list-style-type: none"> 1) Pump running at reduced speed. 	<ol style="list-style-type: none"> 1) See above.
Motor overheats (protector trips)	<ol style="list-style-type: none"> 1) Low voltage. 2) Inadequate ventilation. 3) Wiring too small. 	<ol style="list-style-type: none"> 1) Contact your electrician. 2) Refer to installer/dealer. 3) Contact your electrician.
Chromatherapy doesn't function	<ol style="list-style-type: none"> 1) Not plugged in. 2) Bulb burned out. 3) Disconnected or defective wiring. 	<ol style="list-style-type: none"> 1) Plug in. 2) Replace bulb. 3) Check and reconnect if needed.
Pump delivers no water	<ol style="list-style-type: none"> 1) Jets are closed. 2) Leakage of air into suction system. 3) Impeller clogged. 	<ol style="list-style-type: none"> 1) Open jets. 2) Check suction screen for clogs. 3) Clean and unplug.
Low pump capacity	<ol style="list-style-type: none"> 1) Suction or discharge line partly plugged. 2) Pump running at reduced speed. 3) Impeller clogged. 	<ol style="list-style-type: none"> 1) Clean and unplug. 2) See "Motor does not reach full speed." 3) Clean and unplug.
Noisy pump and motor	<ol style="list-style-type: none"> 1) Worn motor bearings. 2) Pumps touching a stationary object. 3) Suction line partly plugged. 4) Pump not supported properly. 	<ol style="list-style-type: none"> 1) Contact Aquatic 2) Refer to installer/dealer. 3) Clean and unplug. 4) Contact Aquatic (If you have a remote blower/pump, refer to installer/dealer.)
Leakage of water at shaft	<ol style="list-style-type: none"> 1) Shaft seal requires replacement. 	<ol style="list-style-type: none"> 1) Contact Aquatic
Leaking unions	<ol style="list-style-type: none"> 1) O-ring missing or damaged. 2) Plumbing in a bind. 3) Loose unions. 	<ol style="list-style-type: none"> 1) Contact Aquatic 2) Contact Aquatic 3) Tighten unions.
Vibration noise	<ol style="list-style-type: none"> 1) Tub or tub plumbing is touching tile/wall. 2) Pump is touching framing. 	<ol style="list-style-type: none"> 1) Refer to installer/dealer. 2) Refer to installer/dealer.
Air Bath system does not operate	<ol style="list-style-type: none"> 1) No power to air blower. 2) Blower Control Box is not plugged in. 3) Control Panel connector to controller box is disconnected. 4) Blower Motor is disconnected from control box. 	<ol style="list-style-type: none"> 1) Reset circuit breakers and GFCI if tripped. 2) Make sure plug is fully inserted into the outlet. 3) Check and reconnect if needed. 4) Plug Blower into control box.
Blower turns off by itself or before time elapses	<ol style="list-style-type: none"> 1) Blower motor overheated and thermal protection device deactivated motor (possibly low voltage). 2) GFCI tripped. 	<ol style="list-style-type: none"> 1) Check that blower has sufficient ventilation, and that the intake to the blower is not blocked, clear and allow motor to cool down. (Check service & wire size.) 2) Refer to installer/dealer.
Circuit breaker trips repeatedly	<ol style="list-style-type: none"> 1) Defective breaker. 2) Sort circuit between bath and breaker box. 3) Other items are connected to the same circuit. 	<ol style="list-style-type: none"> 1) Change out breaker. 2) Refer to installer/dealer. 3) Refer to installer/dealer.
Blower does not manually shut off	<ol style="list-style-type: none"> 1) Defective control panel. 2) Defective control box. 	<ol style="list-style-type: none"> 1) Refer to installer/dealer. Replace control panel. 2) Refer to installer/dealer. Replace control box.
Air blower does not function properly while in the pulse or wave modes	<ol style="list-style-type: none"> 1) Speed of air setting is set too low. 	<ol style="list-style-type: none"> 1) Change the air speed setting to a mid-range setting before switching to wave or pulse modes.

INFINITY SERIES

REPLACEMENT PARTS MAP

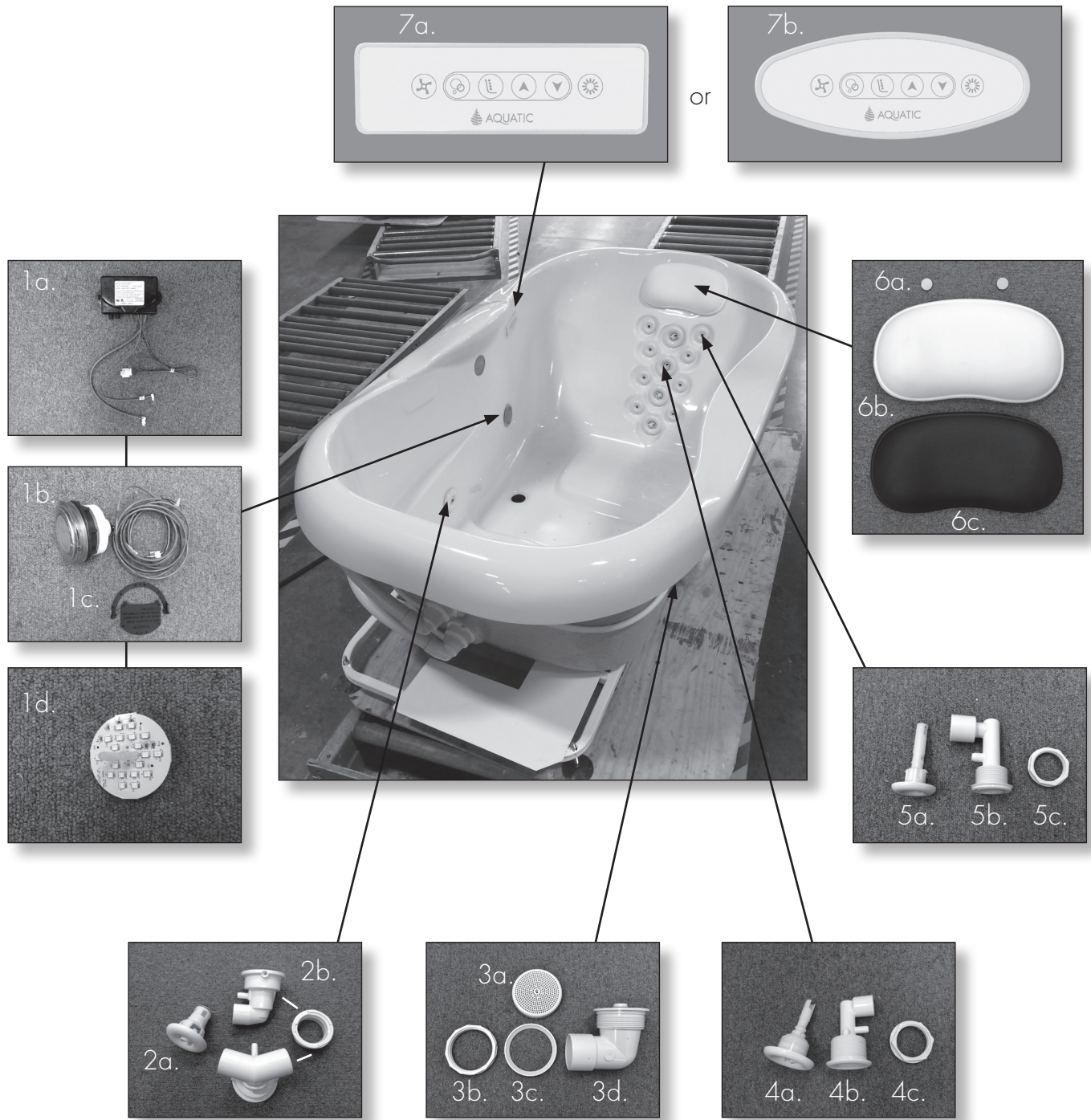

INFINITY SERIES

REPLACEMENT PARTS MAP

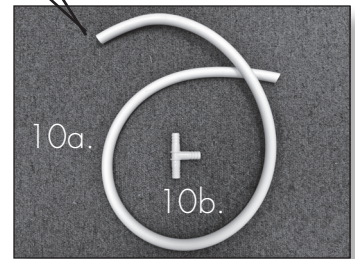
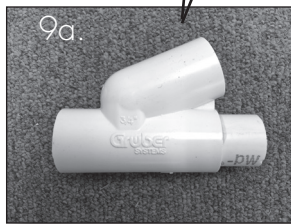
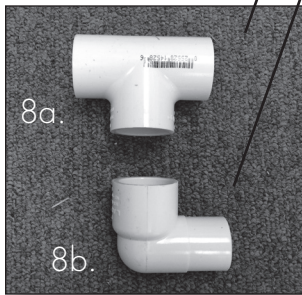
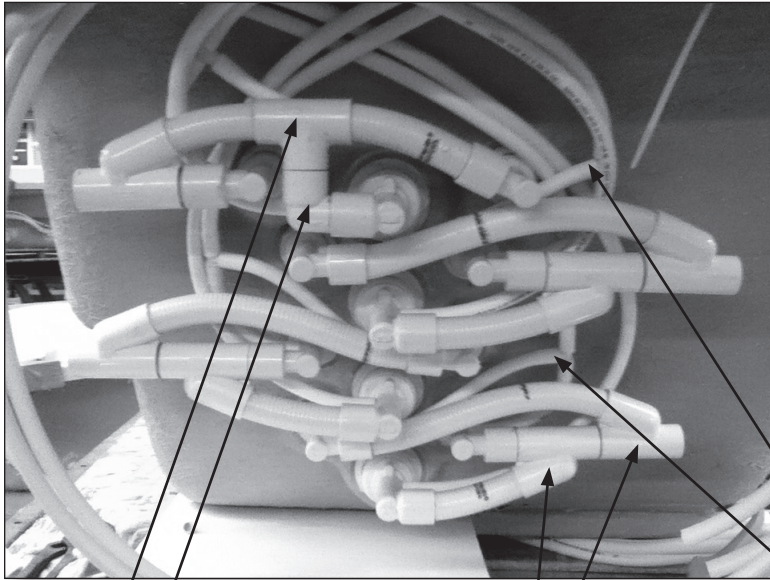

INFINITY SERIES

REPLACEMENT PARTS MAP

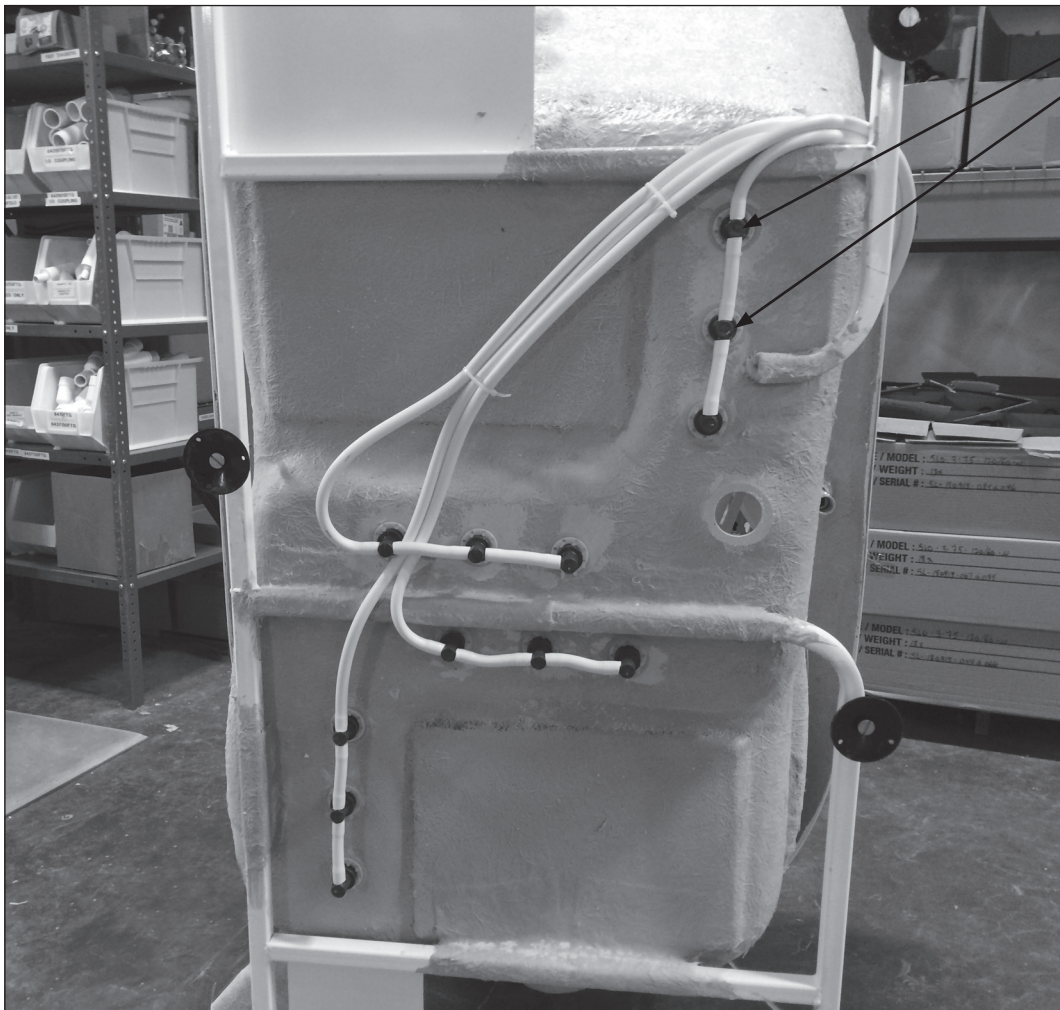
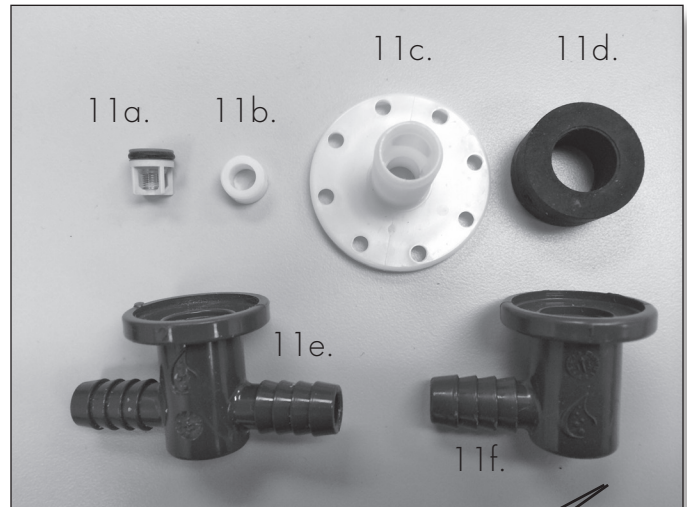

INFINITY SERIES

REPLACEMENT PARTS MAP

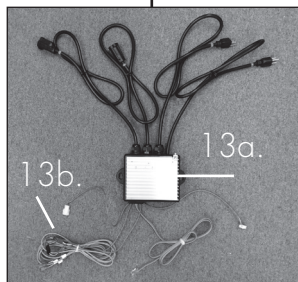
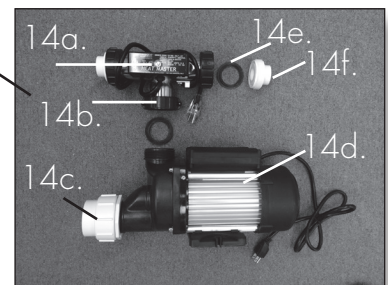
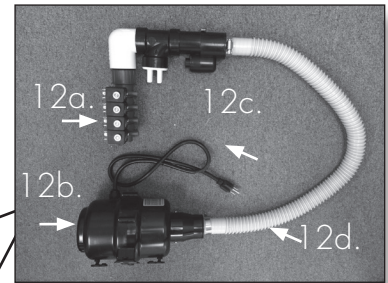
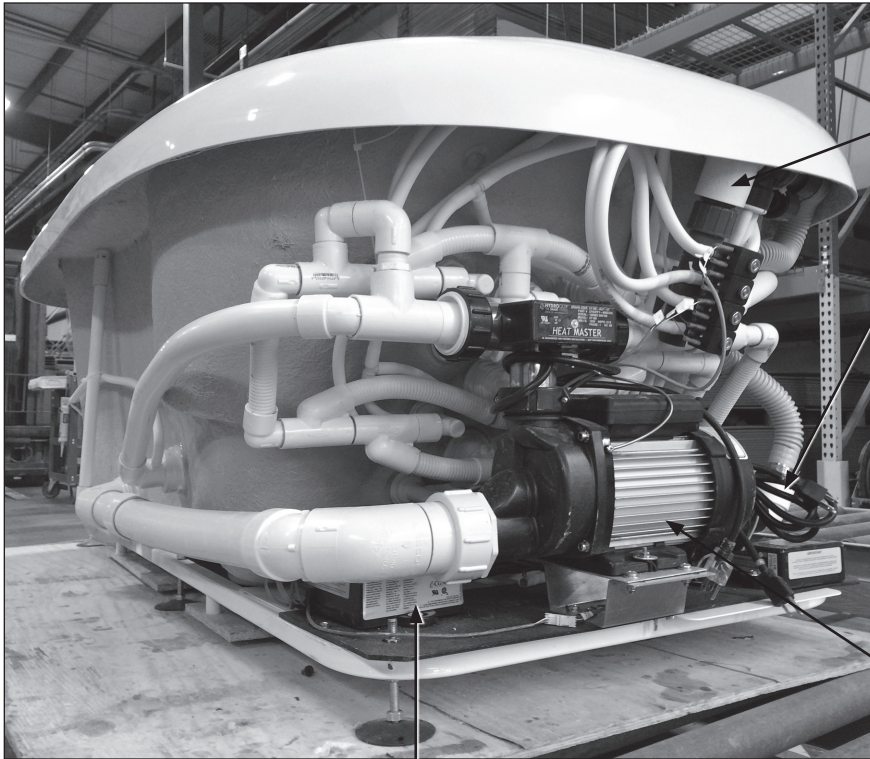

INFINITY SERIES REPLACEMENT PARTS LIST

ILLUSTRATION NO.	PART #	DESCRIPTION
1A.	8131BOX	CNTRL;CHROMATH;SLAVE CNFG.;TO6
1B.	8020LIGHTS	CHROMATHERAPY;20LEDS BULB;RND CLR
	–	LENS REMOVAL TOOL
	–	20LEDS CHROMATHERAPY BULB
2A.	8186ASSYxx	FULL SIZE DIRECTIONAL JET
2B.	8186VJTB	VJET BODY
	8186BDY	90 DEGREE JET BODY
	8186WFTG	WALL FITTING
3A.	1120xx	150GPM SUCTION COVER
3B.	1122NUT	150GPM SUCTION NUT
3C.	1124RING	150GPM SUCTION COMP RING
3D.	1121ELBOW	150GPM SUCTION ELBOW
	1119SLIP	SUCTION SAFETY VALVE
4A.	8180ROTxx	ROTATIONAL SWIRL JET
4B.	8180JTB	ROTATIONAL SWIRL JET BODY
4C.	8180NUT	JET NUT
5A.	8182DIRWH	PRESSURE PLUS JET INTERNAL
5B.	8182JTB	PRESSURE PLUS JET BODY
5C.	8182NUT	PRESSURE PLUS JET NUT
6A.	9250MAGNET	PILLOW MAGNET;ROUND;3/4"X1/8"
6B.	9250PILLWH	MAGNETIC PILLOW; WHITE
6C.	9250PILLBK	MAGNETIC PILLOW;BLACK
7A.	8169KEYPAD	KEYPAD;BDL;INFINITY;RECT
7B.	8170KEYPAD	KEYPAD;BDL;INFINITY;OVAL
8A.	8511FTG	3/4" TEE
8B.	8514FTG	3.4" ST 90 EL
9A.	8504FTG	3/4" WYE 22.5 DEG
10A.	1092	3/8" PVC AIR TUBING
10B.	8038TEE	3/8" BARB TEE; AIR
11A.	8012CVALVE	14MM ILLUSION CHECK VALVE
11B.	–	14MM ILLUSION JET STOPPER
11C.	–	14MM ILLUSION JET BODY
11D.	–	14MM ILLUSION WASHER
11E.	8012TEE	ILLUSION TEE
11F.	8012ELBOW	ILLUSION ELBOW
12A.	8504SEQ	4 PORT AIR SEQUENCER MODULE KIT
12B.	1104BLOWER	BLOWER;750W;HEATER;120V;W/NEMA
12C.	8173MANIFOLD	AIR MANIFOLD;1.5" / 3.8" SPG-4
12D.	1093	3FT INTAKE HOSE W/ CLAMPS
13A.	8135BOX	CONTROL BOX;EVO 2; SOFTWARE AQ01
13B.	–	AIR SEQUENCER COMMUNICATION CABLE
14A.	8095HEATER	1.5 KW MAINTENENCE HEATER
14B.	–	2PC. HEATER SPLIT NUT
14C.	8515FTG	2" X 1.5" ADAPTER/ PUMP UNION
14D.	8108MOTOR	1.75HP /120V PUMP
14E.	–	GASKET / O-RING
14F.	–	1.5" X 1" TAILPIECE

* To indicate color, replace "XX" with "WH" for White, "BO" for Bone, "BK" for Black, "ST" for Sterling Silver, "BI" for Biscuit, "CR" for Chrome, "BR" for Brass, "BN" for Satin Nickel



Aquatic Limited Lifetime Warranty

FOR INFINITY SERIES BATHS

Limited Warranty For Original Consumer For Household Usage

WHAT PRODUCTS ARE COVERED

Structures and surface finishes, pumps and blowers on the Infinity.

Warranty Periods for Specific Components

LIFETIME WARRANTY FOR WHIRLPOOL/AIR BATH/TUB SHELL, PUMP AND BLOWER

Aquatic extends to the original consumer purchaser of the acrylic, fiberglass reinforced shell, a non-transferable lifetime warranty that the shell will retain its structural integrity and configuration and be free of water loss due to a defect in the tub shell. The warranty covers the tub shell and the factory installed pump and blower against defects in material or workmanship. This warranty does not apply to all other components (attachments to the acrylic, fiberglass reinforced shell, such as plumbing, fittings and other apparatus) because these pieces are covered below under a 2 Year Warranty.

LIFETIME SURFACE WARRANTY FOR FACE OF WHIRLPOOL/AIR BATH/TUB

The interior surface is warranted against fading, blistering, cracking and delamination due to defects in the surface materials for life. This surface warranty extends to defects due to surface material mixing or molding. This surface warranty does not apply to fading, cracking, delamination or blistering due to *excessive wear, sun fading or scouring due to cleaning.*

2 YEAR EQUIPMENT WARRANTY FOR SUPPORT EQUIPMENT, COMPONENTS, CONTROLS & PLUMBING EQUIPMENT

All support equipment; components, controls and plumbing equipment are warranted for 2 years from date of purchase, but not more than 3 years from date of manufacture, against defects in workmanship and materials. Light bulbs, fuses and pillows are not included in this two-year period. However, these accessories are warranted to be free from defects in materials and workmanship at the time of delivery to the original purchaser. Limited labor is covered for 2 years from purchase, but never more than 3 years from date of manufacture, for limited labor on the support equipment, controls, and plumbing.

EXCLUSIVE REMEDY

Aquatic will, **at its option**, repair or replace (without removal or installation) the affected components of any defective Unit or System; repair or replace (without removal or installation) the entire defective Unit or System; or refund the then-current list price of the Whirlpool, Air Bath, or Tub. In all cases, a reasonable time period must be allowed for warranty repairs to be completed.

WHAT YOU MUST DO

In order to make a claim under these warranties:

1. You must be the original consumer purchaser of the Whirlpool, Air Bath, or Tub.
2. You must promptly notify us within the warranty period of any defect and provide us with any substantiation that we may reasonably request.
Write to: Aquatic 1521 N. Cooper, Ste. 500 Arlington, TX 76011.
3. The Whirlpools, Air Baths, and Tubs must have been installed and maintained in accordance with good industry practice and the specific Aquatic directions contained in the Owner's Manual and Installation Guide.

EXCLUSIONS

These warranties do not extend to or do not cover defects caused by:

1. Shipping damage by carriers or installation errors.
2. Accident, acts of God, abuse or misuse.
3. Unreasonable use (including any use for non-bathing purposes or failure to provide reasonable and necessary maintenance as specified in Aquatic Owner's Manual and Installation Guide supplied with the Whirlpool, Air Bath or Tub).
4. Any alteration, customization, or modification of the Whirlpool/Air Bath/Tub or its components.

LIMITATIONS

1. Aquatic whirlpools and tubs sold for industrial, commercial and hotel use are warranted for two years, but not more than 3 years from date of manufacture, with a 2 year limited warranty that the shell will retain its structural integrity and configuration and be free of water loss due to a defect in the tub. The interior surface/face of the whirlpool/air bath/tub is warranted against fading, blistering, cracking and delamination due to defects in the surface materials for 2 years as well. All support equipment, components, controls and plumbing equipment and limited labor on the support equipment, controls, or plumbing are warranted for 1 year from date of purchase, but not more than 2 years from date of manufacture. Pump seals, "O" rings, light bulbs, fuses and pillows are not included in this two-year period. However, these accessories are warranted to be free from defects in materials and workmanship at the time of delivery to the original purchaser.
2. **In all cases, Aquatic reserves the right to fully satisfy its obligations under the Limited Warranties by refunding the then-current list price of the defective Whirlpool, Air Bath, or Tub (or, if the Whirlpool, Air Bath, or Tub has been discontinued, of the most nearly comparable current product).**
3. **THESE WARRANTIES ARE NON-TRANSFERABLE TO ANY OTHER PURCHASER OR PARTY OTHER THAN THE ORIGINAL CONSUMER. NO OTHER AGENT OR PARTY CAN GIVE ANY OTHER WARRANTY OR PROMISE. THIS IS THE SOLE WARRANTY FOR YOUR Aquatic PRODUCT.**
4. Aquatic will not cover any installation or reinstallation costs related to this warranty, except under the limited labor allowance under the 2 Year Equipment Warranty above.

GENERAL

This warranty gives you specific legal rights; you may also have other rights, which vary from state to state. THE DURATION OF ANY IMPLIED WARRANTIES, INCLUDING THE IMPLIED WARRANTIES OF MERCHANTABILITY AND FITNESS FOR A PARTICULAR PURPOSE, ARE LIMITED TO THE DURATION OF THE EXPRESS WARRANTIES HEREIN. Aquatic EXPRESSLY EXCLUDES INCIDENTAL AND CONSEQUENTIAL DAMAGES, TO INCLUDE LOSS OF TIME, INCONVENIENCE, OR LOSS OF USE OF RESIDENCE, FOR ANY BREACH OF THE EXPRESS OR IMPLIED WARRANTY, INCLUDING THE IMPLIED WARRANTIES OF MERCHANTABILITY OR FITNESS FOR A PARTICULAR PURPOSE.

SOME STATES DO NOT ALLOW ANY LIMITATION ON HOW LONG AN IMPLIED WARRANTY LASTS, OR THE EXCLUSION OR LIMITATION OF INCIDENTAL OR CONSEQUENTIAL DAMAGES; SO THE ABOVE EXCLUSION MAY NOT APPLY TO YOU.



AQUATIC

Where Inspiration Takes Shape

AQUATIC

Fax-On-Demand System: Toll Free (877) 618-7024
8101 E. Kaiser Blvd., Suite 200 • Anaheim, CA 92808
(800) 945-2726 • Fax (866) 544-5353 • www.aquaticbath.com

8MANINF | F.O.D. 9001 | REV. 01.14