

G71 48" x 60" Inside Corner Grab Bar

Model #: G71-48-60-IC-

FEATURES:

- Structurally engineered 90° angle
- ADA compliant when properly installed
- Horizontal section can be used as towel bar
- Style options to complement all collections
- Optional handshower sliders can be added to either bar only upon initial order
- All grab bars can be custom sized. Contact JACLO for pricing & availability
- BAR WILL BE 5" LONGER THAN LISTED LENGTH FROM CENTER OF OUTSIDE POST TO WALL
- *NOTE: GRAB BARS OVER 32" REQUIRE A MIDDLE POST
- NOT AVAILABLE in PG or SG. For large quantity orders, please contact hospitality@jaclo.com



AVAILABLE FINISHES:

Polished Chrome (PCH)	Satin Chrome (SC)	Bronze Umber (BU)
Satin Nickel (SN)	Pewter (PEW)	Caramel Bronze (CB)
Polished Nickel (PN)	Antique Brass (AB)	Antique Copper (ACU)
Oil-Rubbed Bronze (ORB)	Polished Brass (PB)	Polished Copper (PCU)
Vintage Bronze (VB)	Satin Brass (SB)	Matte Black (MBK)
Black Nickel (BKN)	White (WH)	Unlacquered Brass (ULB)
Satin Cooper (SCU)	Almond (ALD)	Amber (AMB)
Azure Blue (AZB)	Coral (COR)	Mint Green (GRN)
Stone Grey (GRY)	Lilac (LAC)	Light Blue (LBL)
Limon (LIM)	Plum (PLM)	Pink (PNK)
Red (RED)	Graphite (GPH)	
Aged Unlacquered Brass (AUB)		

SPECIFICATION DRAWING:

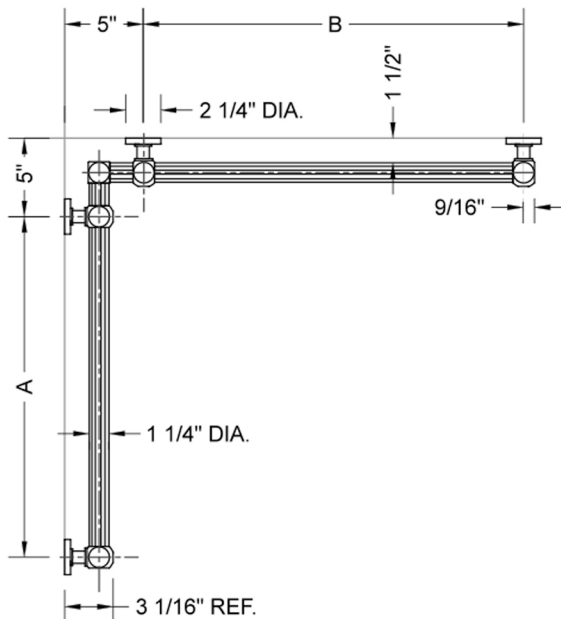

BRASS LUXURY GRAB BAR							
PART. #	DESCRIPTION	A	B	PART. #	DESCRIPTION	A	B
G71-12-12-IC	CENTER OF POST	12"	12"	G71-24-36-IC	CENTER OF POST	24"	36"
G71-12-16-IC	CENTER OF POST	12"	16"	G71-24-48-IC	CENTER OF POST	24"	48"
G71-12-24-IC	CENTER OF POST	12"	24"	G71-24-60-IC	CENTER OF POST	24"	60"
G71-12-32-IC	CENTER OF POST	12"	32"				
				G71-32-32-IC	CENTER OF POST	32"	32"
G71-12-36-IC	CENTER OF POST	12"	36"	G71-32-36-IC	CENTER OF POST	32"	36"
G71-12-48-IC	CENTER OF POST	12"	48"	G71-32-48-IC	CENTER OF POST	32"	48"
G71-12-60-IC	CENTER OF POST	12"	60"	G71-32-60-IC	CENTER OF POST	32"	60"
G71-16-16-IC	CENTER OF POST	16"	16"	G71-36-36-IC	CENTER OF POST	36"	36"
G71-16-24-IC	CENTER OF POST	16"	24"	G71-36-48-IC	CENTER OF POST	36"	48"
G71-16-32-IC	CENTER OF POST	16"	32"	G71-36-60-IC	CENTER OF POST	36"	60"
G71-16-36-IC	CENTER OF POST	16"	36"	G71-48-48-IC	CENTER OF POST	48"	48"
G71-16-48-IC	CENTER OF POST	16"	48"	G71-48-60-IC	CENTER OF POST	48"	60"
G71-16-60-IC	CENTER OF POST	16"	60"				
				G71-60-60-IC	CENTER OF POST	60"	60"
G71-24-24-IC	CENTER OF POST	24"	24"				
G71-24-32-IC	CENTER OF POST	24"	32"				