

INSTALLATION INSTRUCTIONS

JACLO®

Confidence from start to finish.™

Wall Mounted Accessories

Part #'s:

Roaring 20's/Westfield: 4830-RH, 4830-TR, 4830-TB-24, 4830-TB-18, 4830-TP, 4830-SD, 4830-TH, 4830-GS-24

Astor: 4870-RH, 4870-TR, 4870-TB-24, 4870-TB-18, 4870-TP, 4870-SD, 4870-TH, 4870-GS-24

Styles vary. Astor shown.

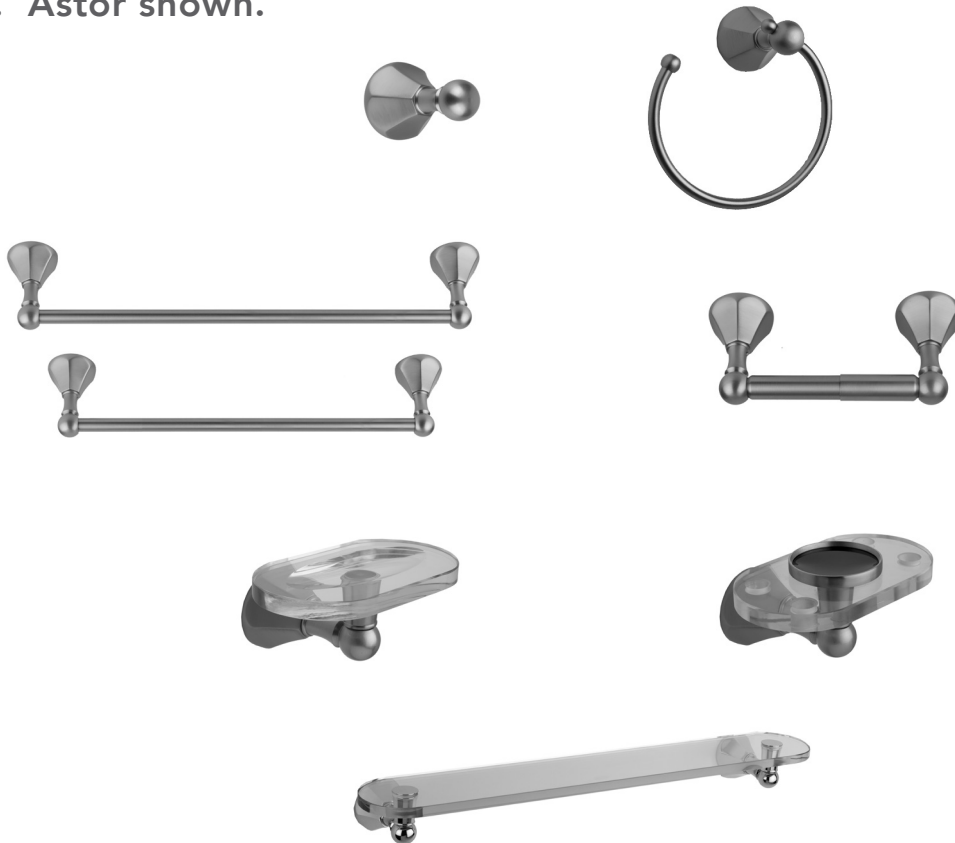

STYLES:

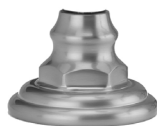

Roaring 20s/Westfield



Astor

| ITEM | DESCRIPTION | PART # |
|------|-----------------------------|-----------------|
| 1 | Mounting Post | 4800-MF-0 |
| 2 | Screw | 7905-ZP-0 |
| 3 | Plastic Wall Anchor | 7905-ZP-0 |
| 4 | Metal Wall Anchor | 7905-ZP-0 |
| 5 | Escutcheon | Varies on model |
| 6 | Accessory Post | Varies on model |
| 7 | Set Screw (2) | 30466-0 |
| 8 | Hex Wrench | 30845-0 |
| 9 | Left T.P. Tube | TP-6-L-** |
| 10 | Spring | TP-7-0 |
| 11 | Right T.P. Tube | TP-6-R-** |
| 12 | Soap Dish or Tumbler Holder | 4800-GI-** |
| 13 | 'O' Ring | |
| 14 | Escutcheon | Varies on model |
| 16 | 24" Towel Bar | 4800-24-BAR-** |
| 16 | 24" Glass Shelf | 4800-GS-0 |
| 17 | 18" Towel Bar | 4800-18-BAR |

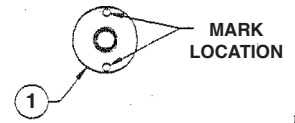

Fig. 1

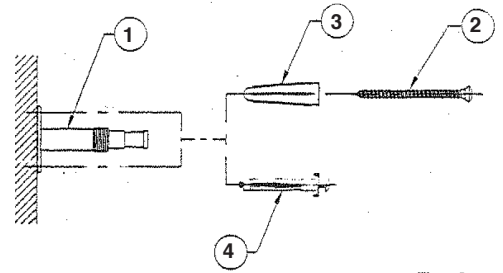

Fig. 2

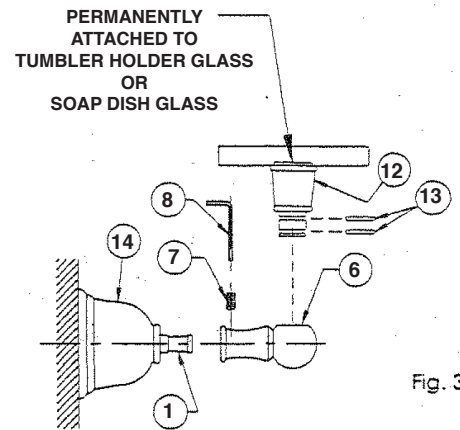

Fig. 3

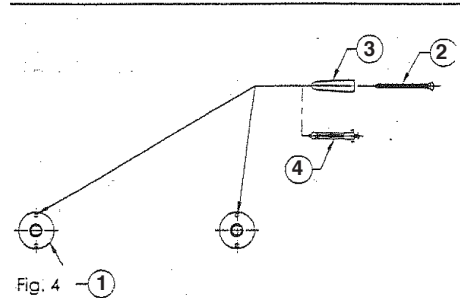
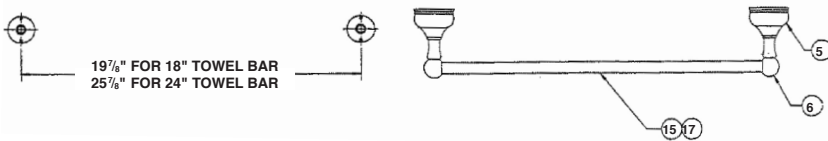
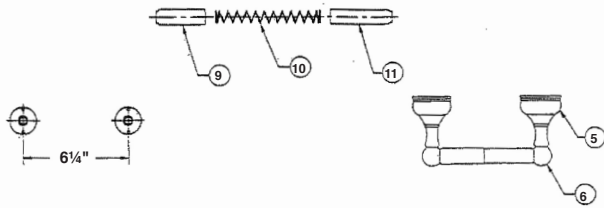

Fig. 4

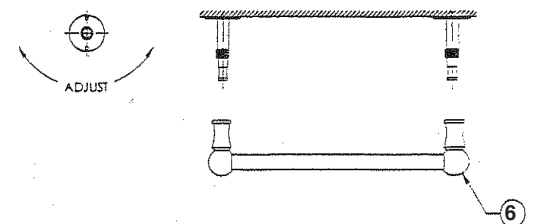
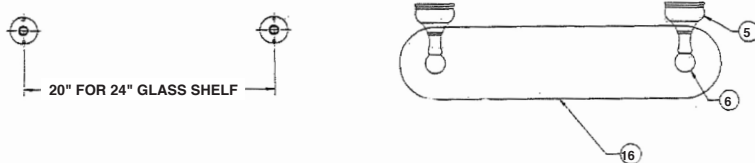

Fig. 5

SINGLE POST INSTALLATION FOR:

Robe hook, Towel ring, Toilet Paper Holder

1. Place mounting post **(1)** on wall in desired location and mark location of mounting holes **(Fig. 1)**.
2. Select the hardware **(2 & 3)** or **(4)** that best suits your application and secure mounting post **(1)** to wall **(Fig. 2)**.
3. Place mounting post **(1)** on wall in desired location and mark location of mounting holes **(Fig. 1)**.
4. Slide accessory post **(6-varies with accessory)** onto mounting post **(1)** until it touches the top of escutcheon **(5)** and secure with set screw **(7)**.

DOUBLE POST INSTALLATION FOR:

Toilet Paper Holder, Towel Bar, Glass Shelf

1. Select the hardware **(2 & 3)** or **(4)** and attach both mounting posts **(1)** to the wall using the top mounting hole only **(Fig. 4)**. Select correct center line for accessory. Tighten mounting screw lightly. Do not secure.
2. Loosely assemble accessory with accessory post **(6)** onto mounting post. Adjust mounting post as shown and mark location for second mounting screw **(Fig. 5)**.
3. Remove accessory and secure mounting post to wall using remaining hardware.
4. Thread escutcheon **(5 -style varies)** onto mounting post **(1)**.
5. Slide accessory with accessory post **(6)** onto mounting post **(1)** until it touches the top of escutcheon **(5)** and secure with set screw **(7)**.

To learn more about JACLO's warranty, please visit [**jaclo.com**](http://jaclo.com)