



Features

- Over 30 finishes including 11 PVD finishes
- All brass construction
- Matching handle & escutcheon for all California Faucets series
- Bar pivots 180° without loosening slide handle
- Handshower holder slides up and down on bar
- Handshower holder angle is adjustable
- Handshower holder accepts conical end of hose
- Right or left handed based on installation
- Includes all mounting hardware
- See www.calfaucets.com for complete selection

Codes/Standards Applicable

Specified model meets or exceeds the following:

- ASME A112.18.1/CSA B125.1
- ADA (all lever handles)

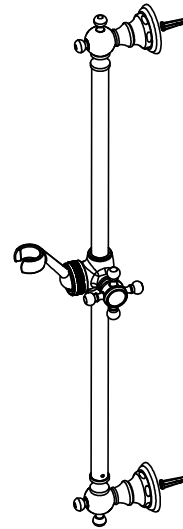

SB-XX

XX = SERIES HANDLE

TABLE (ALL DIMENSIONS SHOWN IN INCHES)				
SERIES	A	B	C	D
33	2 ¹ / ₈	2 ⁹ / ₁₆	3 ¹¹ / ₁₆	3 ¹ / ₂
34	2 ¹ / ₈	2 ⁹ / ₁₆	3 ¹¹ / ₁₆	1 ¹ / ₈
35	2 ¹ / ₈	2 ⁹ / ₁₆	3 ¹¹ / ₁₆	3 ⁷ / ₁₆
36	2 ¹ / ₈	2 ⁹ / ₁₆	3 ¹¹ / ₁₆	3 ¹ / ₁₆
38	2 ⁷ / ₈	2 ¹¹ / ₁₆	3 ³ / ₄	2 ⁷ / ₈
40	2 ¹³ / ₁₆	2 ⁵ / ₈	3 ³ / ₄	3 ¹ / ₄
42	2 ¹³ / ₁₆	2 ⁵ / ₈	3 ³ / ₄	2 ¹⁵ / ₁₆
46	2 ⁵ / ₁₆	2 ³ / ₈	3 ¹ / ₂	3 ⁷ / ₁₆
47	2 ⁵ / ₁₆	2 ³ / ₈	3 ¹ / ₂	1 ³ / ₈
50	2 ⁹ / ₁₆	2 ⁵ / ₁₆	3 ³ / ₈	2 ¹³ / ₁₆
51	3 ¹ / ₄	2 ¹¹ / ₁₆	3 ¹³ / ₁₆	1 ¹ / ₁₆
55	2 ¹³ / ₁₆	2 ⁵ / ₈	3 ³ / ₄	3 ⁵ / ₁₆
59	2 ¹³ / ₁₆	2 ¹³ / ₁₆	3 ⁷ / ₈	3
60	2 ¹ / ₈	2 ⁵ / ₁₆	3 ⁷ / ₁₆	1 ⁵ / ₁₆
63	2 ⁵ / ₁₆	2 ³ / ₈	3 ¹ / ₂	1 ⁹ / ₁₆
64	2 ¹³ / ₁₆	2 ¹³ / ₁₆	3 ⁷ / ₈	3 ⁵ / ₁₆
67	2 ¹ / ₈	2 ⁵ / ₁₆	3 ⁷ / ₁₆	1 ³ / ₈
68	2 ¹ / ₈	2 ⁹ / ₁₆	3 ¹¹ / ₁₆	3 ³ / ₈
69	2 ¹ / ₈	2 ⁹ / ₁₆	3 ¹¹ / ₁₆	3 ¹ / ₂

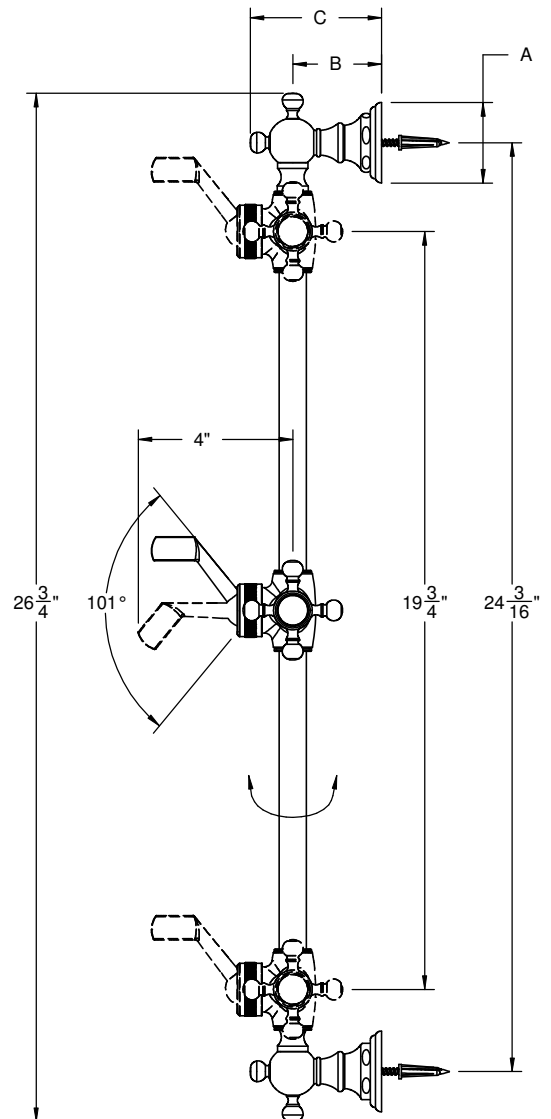
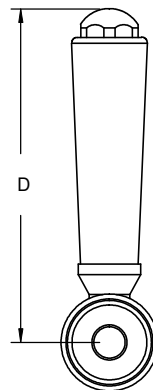
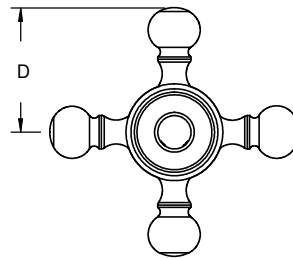

ALL DIMENSIONS SHOWN TO NEAREST 1/16"



Features

- Over 30 finishes including 14 PVD finishes
- Solid brass construction
- 1/2" NPT (female) inlet connection
- 1/2" NPSM (male) outlet connection

SH-10-42

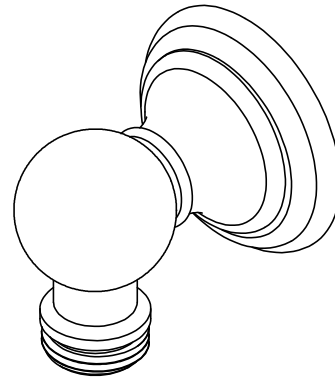

Codes/Standards Applicable

Meets or exceeds the following at date of manufacture:

- ASME A112.18.1/CSA B125.1

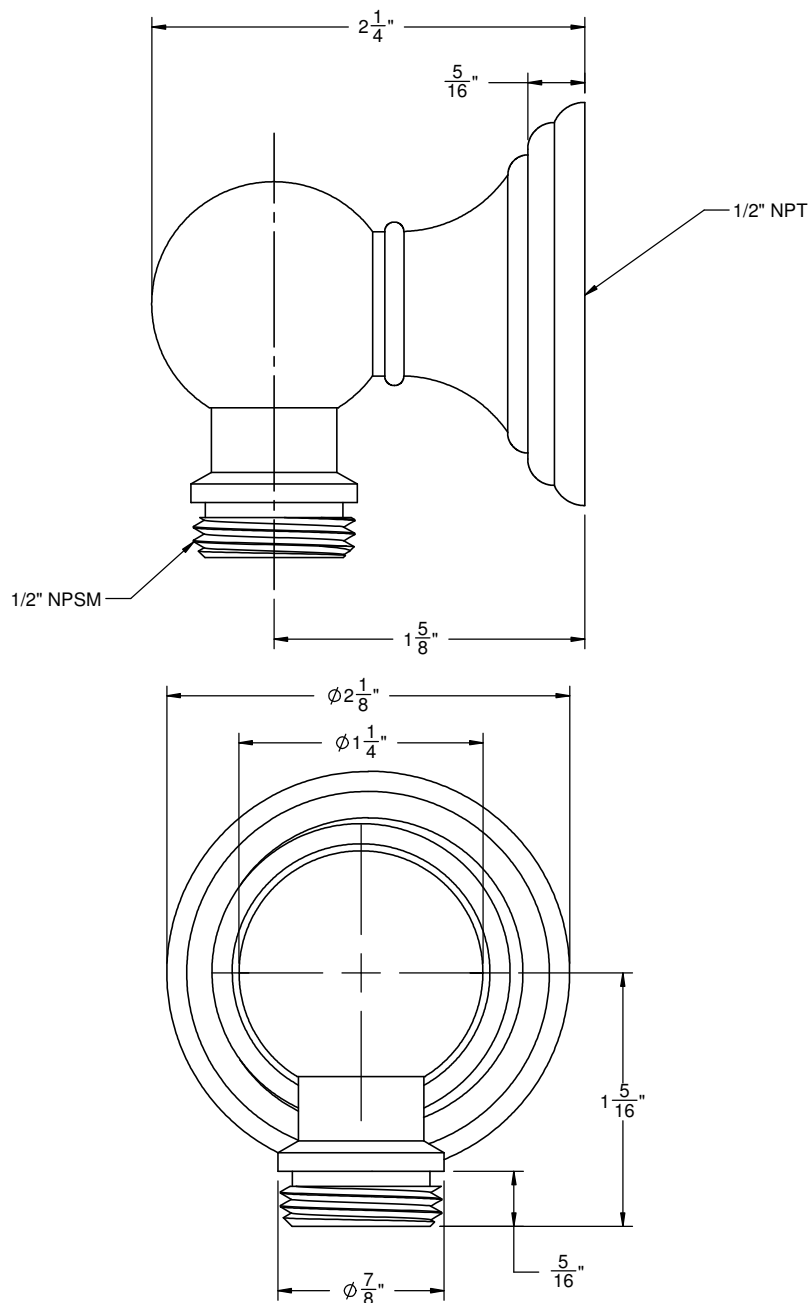

ALL DIMENSIONS SHOWN TO NEAREST 1/16"