

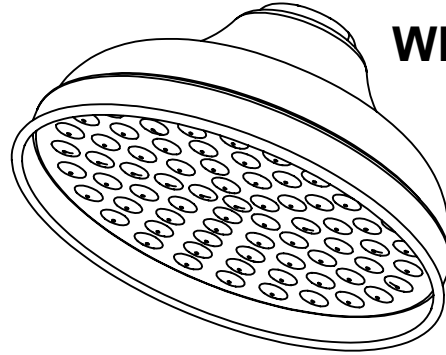

Features

- Over 30 finishes including 14 PVD finishes
- Solid brass construction
- 6" face diameter
- 1/2" FIP inlet
- 2.5 gpm (9.5 Lpm) max flow rate
- Order **WE** for 2.0 gpm (7.6 Lpm) max flow rate

SH-106
WE-SH-106



Codes/Standards Applicable

Meets or exceeds the following at date of manufacture:

- ASME A112.18.1/CSA B125.1

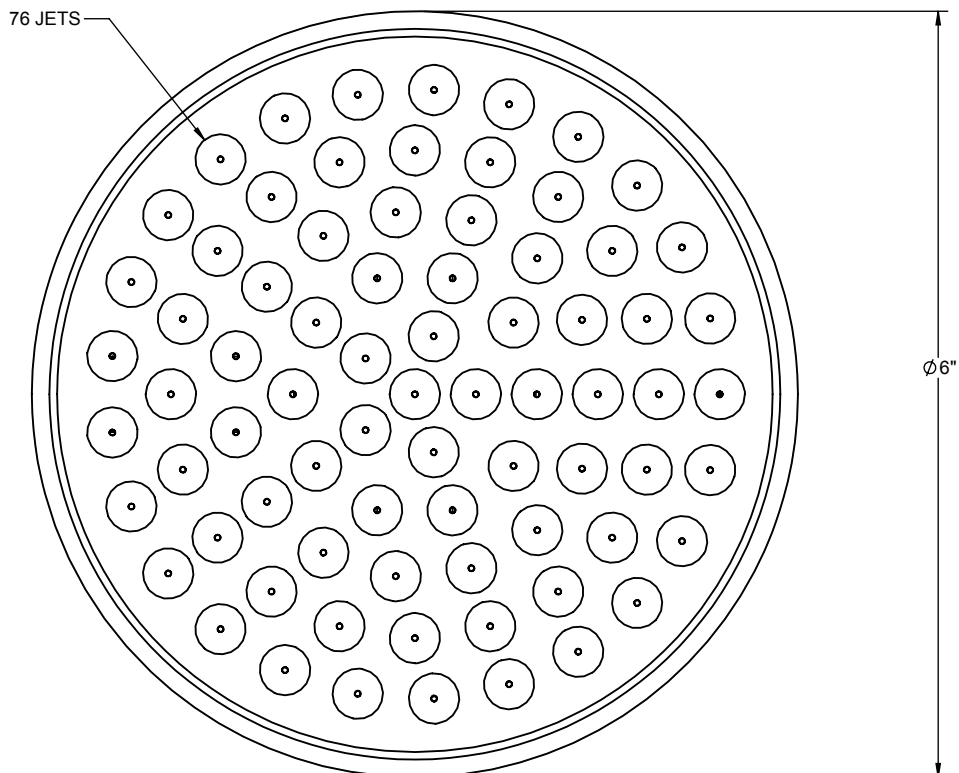
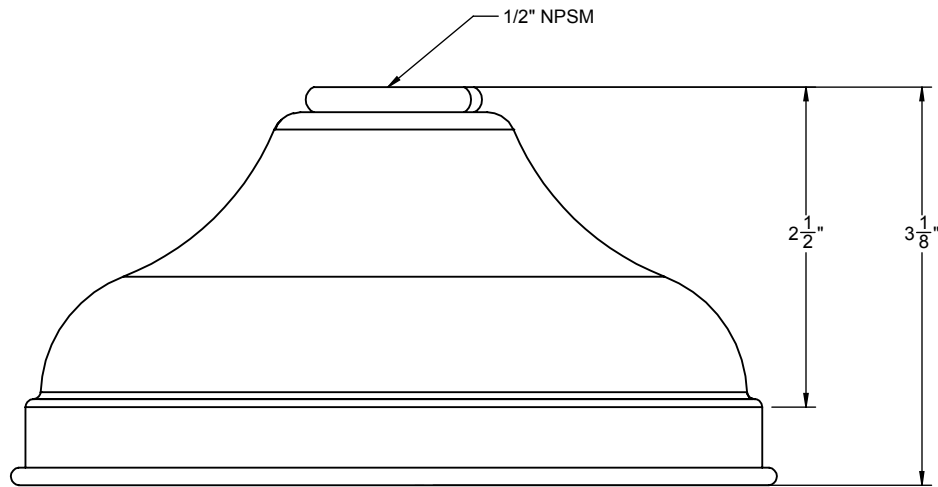

ALL DIMENSIONS SHOWN TO NEAREST 1/16"