



Three Hole Low Level Spout Widespread Lavatory Faucet with Cross Handles

ROHL Perrin & Rowe® Bath

U.3706X*

FEATURES

- Has aerated spout that meets code requirements of 1.5 GPM
- Fixed spout
- Spout, valve housing, and pop-up made from solid brass
- 2 x 1 1/8" hole cutouts, 1 x 1 3/8" hole cutout
- 1/4-turn ceramic disc valves
- Pop-up drain, 1 1/4" pipe
- Unique handle fixing clip, engineered to increase the life of the valve
- 1/2" NPSM connections
- 1 3/4" max. deck depth

COLORS/FINISHES

- Polished Chrome
- Polished Nickel
- Satin Nickel
- Inca Brass
- English Bronze

WARRANTY

- Limited Lifetime

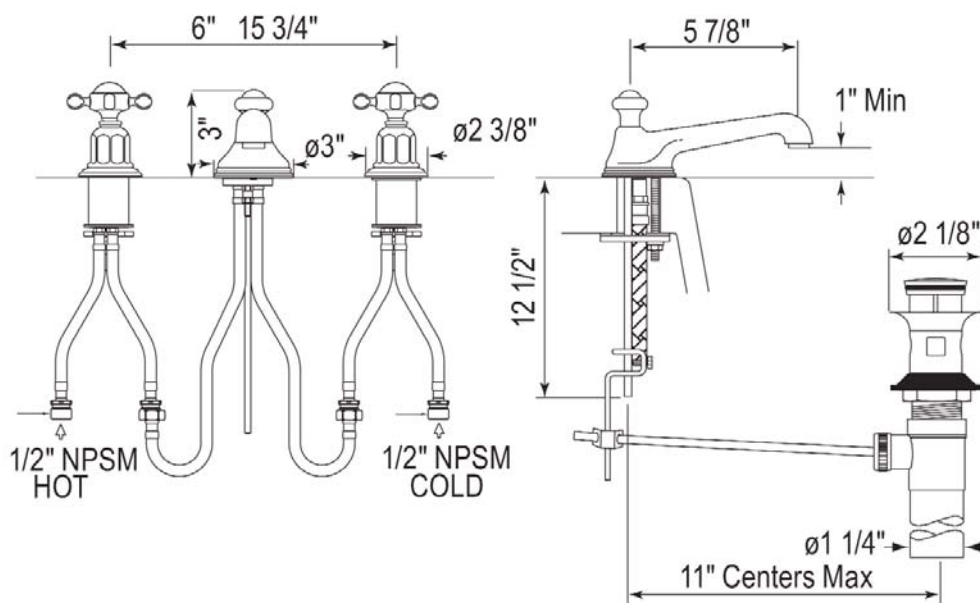

* For CA/VT, place a "-2" at end of model number for code compliant product. (Example A3608LMAPC-2)

Consult your local ROHL showroom for additional information and specifications. For complete warranty details and a list of showrooms, go to www.rohlhome.com.

U.3706X Spare Parts

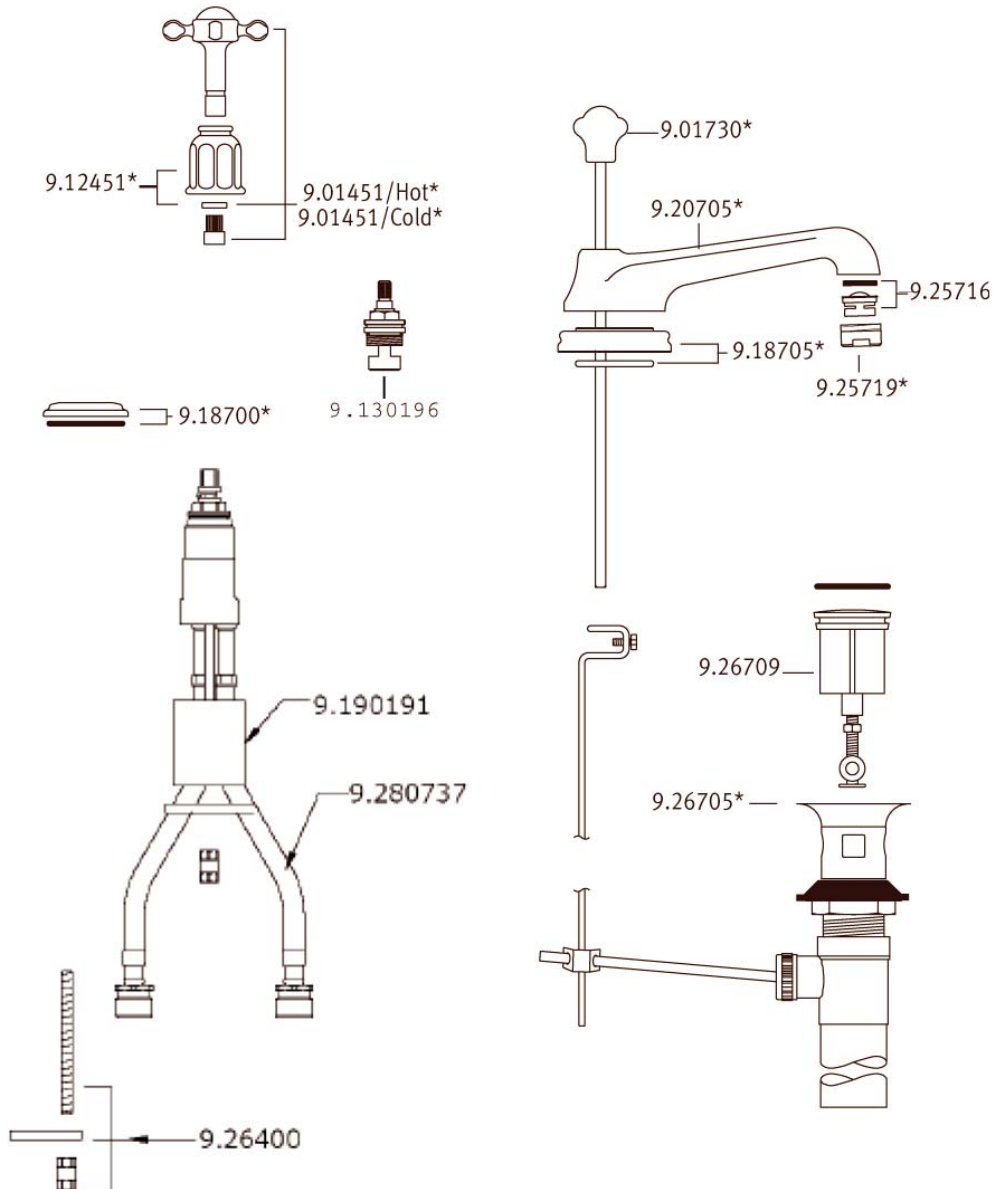

The Traditional Bathroom Collection

Installation & User Guide



U.3700L-2 U.3701X-2 U.3705L-2 U.3706X-2 U.3720L-2 U.3721X-2
 U.3730L-2 U.3731X-2 U.3741L-2 U.3742X-2 U.3760L-2 U.3761X-2
 U.3765L-2 U.3766X-2

3 HOLE WIDESPREADS

Congratulations on the purchase of your Perrin & Rowe Bathroom Faucet. Correctly installed and with sensible care, it will give many years of trouble free service.

Before you proceed... We recommend you engage the services of a registered plumber to install this product.

Read the instructions on this leaflet carefully.

PREPARATION

- ◆ Flush the plumbing system before installing the mixer faucet. This is to avoid plumbing residues clogging the aerated outlet, or possibly damaging the ceramic valves. This is especially important where extensive plumbing work has been carried out.
- ◆ The Hot supply should be on the left when viewed from the front of the fitting.

CHECK LIST

- ! Temperature of the hot water supply does not exceed 185°F!
- ! Recommended minimum water supply pressure - 30 psi!
- ! Recommended maximum water supply pressure - 75 psi!
- ! Ideal performance obtained with equal hot & cold pressures!

ASSEMBLY - Refer to Fig 1.

- ◆ Assemble the nozzle by placing the hoses through the hole in the work surface ensuring that the base ring & seal are in place.
- ◆ Place clamp plate and securing nut onto the clamp bolt, tighten with spanner provided to underside of work surface.
- ◆ To assemble sidevalve, ensure the spacer ring, clamp plate and securing nut are in place on the valve body, then from the underside of work surface, push the valve body through the hole. Assemble rosette as shown so that the valve body thread shows at top.
- ◆ Ensure that the connection for the flexible hose is facing towards the nozzle.
- ◆ Spacer washer to be used in installations where work surface has a thickness ranging from 1/8" to 1 7/8".
- ◆ Assemble cover & handle onto the valve body ensuring that it is aligned properly. If it is not, remove and turn a few splines until correct alignment achieved.
- ◆ Screw the rosette up to the underside of cover.
- ◆ Repeat this procedure for the cold valve.

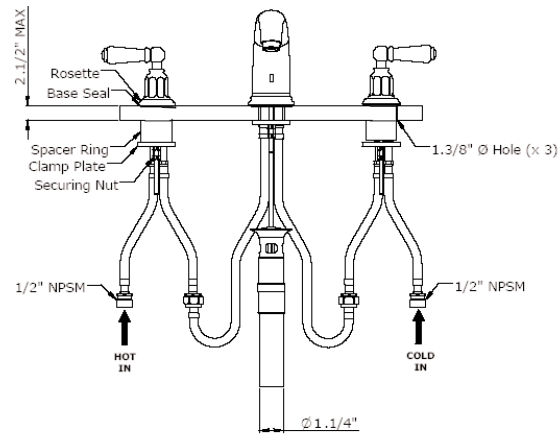

Fig 1.
Installation of Faucet

- ◆ Tighten securing nut to under side of work surface.
- ◆ Connect the side valves to the nozzle using the flexible hoses.
- ◆ Assemble and connect pop-up waste.
- ◆ Ensure all connections are firmly tightened.
- ◆ Connect Hot & Cold water supplies to side valve inlets.
- ◆ Remove pop-up from waste. Unscrew and remove top waste, complete with foam seal, through waste hole in basin/bidet. Offer bottom waste, complete with rubber seal, to underside of basin/bidet and screw top waste into bottom waste. Ensure that pop up shaft is in position alongside pop up rod. (Shaft can be cut shorter if space is restricted). Slide fixed end of clamp bracket onto pop up shaft. Lift pop up rod and then lower into swivel end of clamp bracket. Adjust position of clamp bracket to achieve maximum movement of pop up shaft. Place pop up into waste and adjust movement using the screw in the bottom of the pop up.

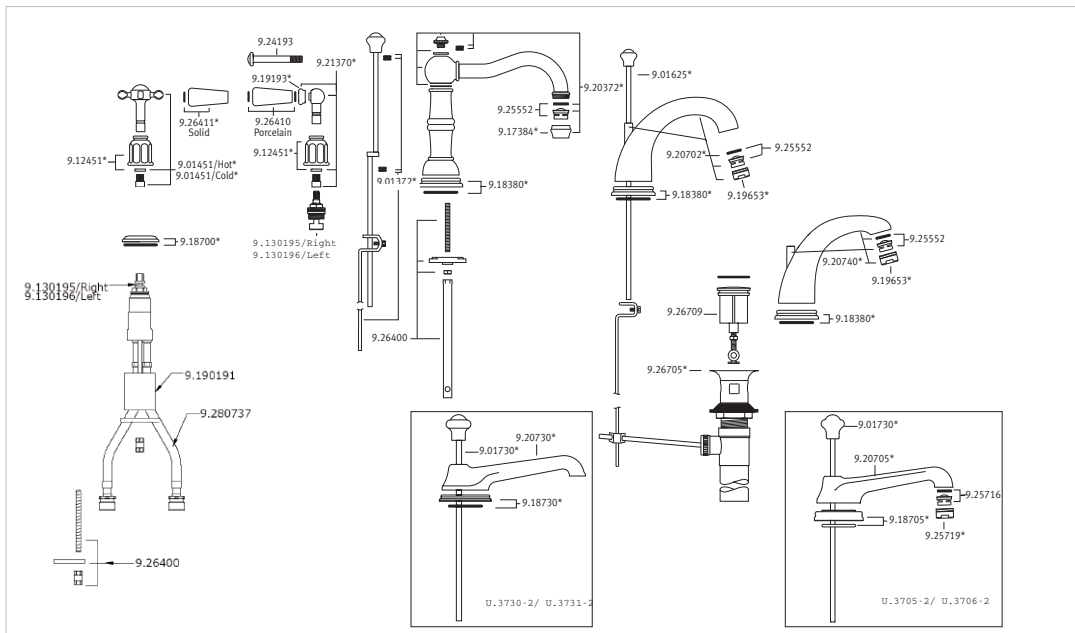

Fig 2.
Spare Parts - *Where indicated specify color

BEFORE USE

- Carefully check the installation for leaks.
- If further building work is to be carried out in the vicinity, cover the faucet with a plastic bag to avoid damaging the finish.
- Please ensure that the installation complies with the local plumbing codes.

OPERATION

Ceramic disc valves are fitted as standard to this mixer tap. Flow from FULLY OFF to FULLY ON is achieved by rotating the handles a quarter turn.

When using pop up waste, push down on plug to seal the waste prior to filling the bowl. Push down on pop up knob to discharge waste water.

SPARE PARTS AND SERVICE

ROHL
3 Parker
Irvine
CA 92618
(714) 557-1933

CARE & MAINTENANCE

Occasional cleaning with warm soapy water, followed by a polish with a soft cloth is all that is required to keep the plated finish in good condition.

Do not use proprietary abrasive liquids, powders, or pads to clean the faucet. You will damage the plated finish and void your guarantee.

An aerator is fitted to the outlet of the spout, this may need occasional cleaning. This will be evident when the water flow slows down to an unacceptable level. To accomplish this unscrew the outlet in a counter-clockwise direction and remove the aerator, rinse thoroughly in clean water and re-install.

GUARANTEE AND LIABILITY

Your bathroom product has been manufactured to the high standard

HANDLE VARIANTS

Both porcelain and solid levers are included with U.3700L-2, U.3705L-2, U.3720L-2, U.3730L-2, and U.3760L-2 models.

HOW TO CHANGE

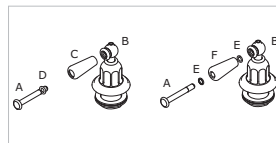

- 1) Unscrew lever bolt **A** from lever ball **B** by hand.
- 2) Remove metal lever insert **C** and seal **D**.
- 3) Place one of the replacement seals **E** onto lever bolt **A** and slide to the end. Place porcelain lever insert **F** onto lever bolt **A** and slide to the end of the bolt.
- 4) Place the other replacement seal **E** onto lever bolt **A** and slide to the end of the porcelain lever insert.
- 5) Screw lever bolt and porcelain lever insert assembly back into lever ball **B** and screw down tightly by hand.