

SANTEC

FLUID IMAGINATION

DESIGNER SERIES

ROBE HOOD & TOWEL RING



KEEP THIS INSTRUCTION BOOKLET FOR FUTURE REFERENCE

Important: Santec reserves the right to request additional documents before servicing warranty requests.

SANTEC has the right to make necessary design changes where applicable.

*Illustration may not depict actual products

PARTS BREAKDOWN

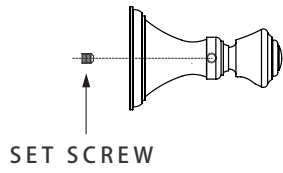

Robe Hook Body

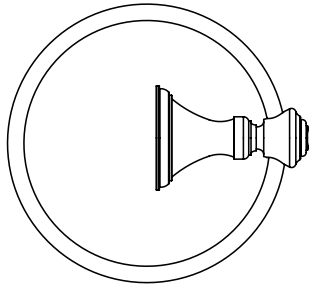

TOWEL RING

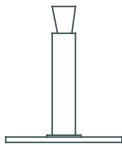

MOUNTING HARDWARE POST



MOUNTING SCREWS (4)



DRY WALL TOGGLES (4)



SOLID WALL ANCHORS (4)



ALLEN KEY

Installation

Remove the Mounting Hardware Post from the Accessory Post and use it as a reference for positioning.

Installing On Wooden Surface

For wooden surface, the Mounting Hardware Post can be secured by threading the Screws directly into the wall.

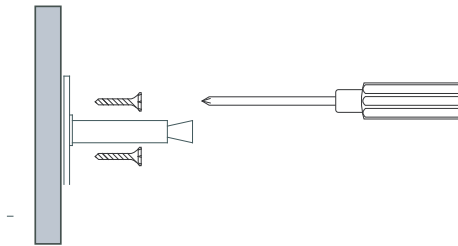

Installing On Drywall

Mark the four screw hole positions by using the Mounting Hardware Post.

Using a drill, pre-drill holes for the Dry Wall Toggles.

Fold the Dry Wall Toggle's leg and insert it into the wall.

The Mounting Hardware Post can be secured by screwing the Screws into the Toggles.

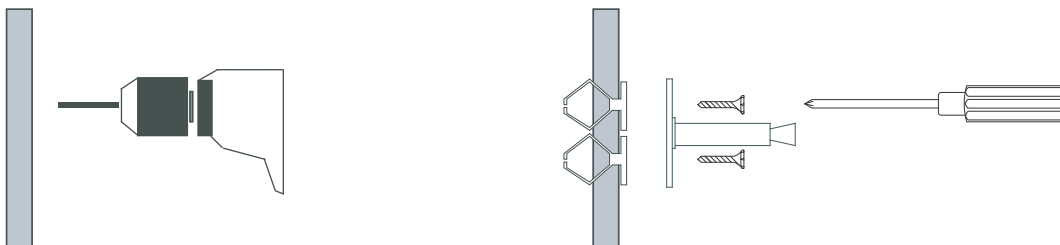

TOWEL BAR

Installing On Solid/Hard Surface

Measuring the dimensions carefully, mark the four screw hole positions by using the Mounting Hardware Post.

Using a drill, pre-drill the holes.

Insert Anchors into the wall.

Secure the Mounting Hardware Post by tightening the Screws into the Anchors.

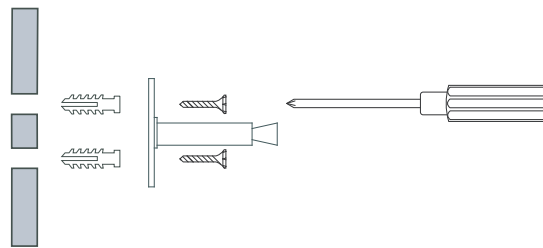
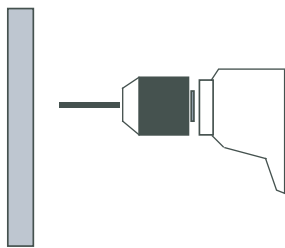

Securing In Position

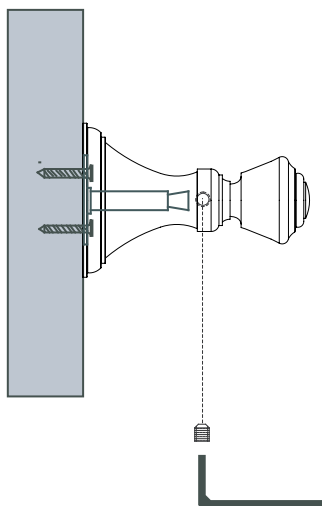

Using the provided Allen key, loosen the Accessory Post's Set Screw.

Slip the Accessory Post onto the Mounting Hardware Post.

Secure the Accessory Post by tightening the Set Screw.