

# SANTEC

FLUID IMAGINATION

DESIGNER SERIES

18", 24", 30" TOWEL BAR



**KEEP THIS INSTRUCTION BOOKLET FOR FUTURE REFERENCE**

Important : Please register your product online at [www.santecfaucet.com](http://www.santecfaucet.com) within 30 days of purchase. Santec reserves the right to request additional documents before servicing warranty requests.

SANTEC has the right to make necessary design changes where applicable.

\*Illustration may not depict actual products

# PARTS BREAKDOWN

---



POST FLANGE WASHERS (2)

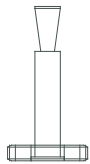

MOUNTING HARDWARE POSTS (2)

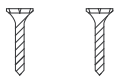
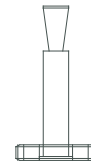

DRY WALL SCREWS (4)

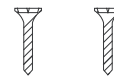

DRY WALL TOGGLES (4)

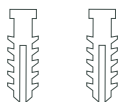

SOLID WALL ANCHORS (4)

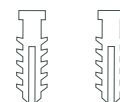

ALLEN KEY

Remove the Mounting Hardware Post from the Bar Posts and use them as references for positioning. Make sure that the Bar is level and the Bar Post positions are correct.

## Installing On Wooden Surface

For wooden surface, the Mounting Hardware Posts can be secured by threading the Screws directly into the wall.

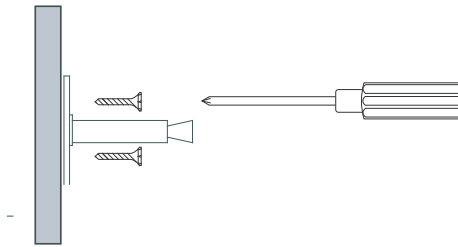

## Installing On Drywall

Mark the four screw hole positions by using the Mounting Hardware Post.

Using a drill, pre-drill holes for the Dry Wall Toggles.

Fold the Dry Wall Toggle's leg and insert it into the wall.

The Mounting Hardware Posts can be secured by screwing the Screws into the Toggles.

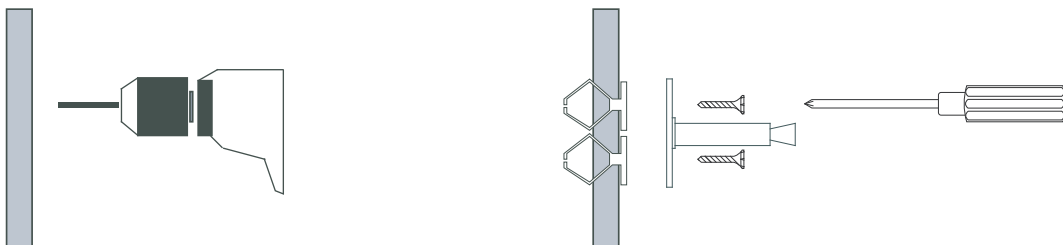

# TOWEL BAR

---

## Installing On Solid/Hard Surface

Measure the dimensions carefully, mark the four screw hole positions by using the Mounting Hardware Post.

Using a drill, pre-drill the holes.

Insert Anchors into the wall.

Secure the Mounting Hardware Posts by tightening the Screws into the Anchors.

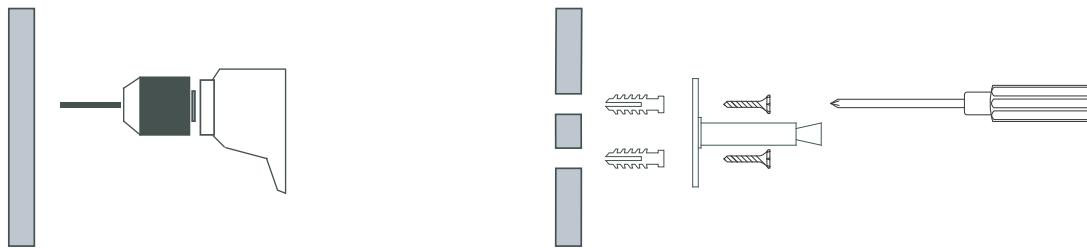

## Measuring the Mounting Hardware Posts

After assembling the first mounting Hardware Post at the desired height, slip one side of the towel Bar into the Mounting Hardware Post and the second post on the wall. mark above ,below, right, and left of the post with a pencil and remove the towel bar assembly. Connect the two lines to find the center.

Place the center of the other Mounting Hardware Post over the mark and check with a level to make sure the height of both is the same. When level and centered, mark the screw hole positions.

## Securing In Position

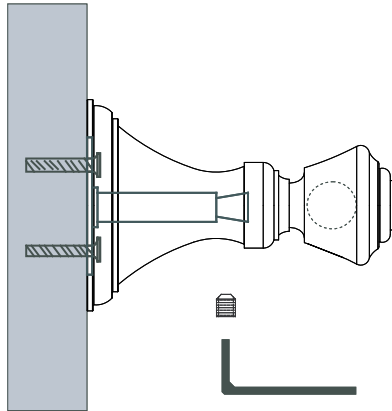

Using the allen key provided, loosen the bar posts' set screws.

Set the bar posts apart from each other onto a flat surface with openings facing each other .

Insert the towel bar into both left and right unsecured bar posts.

Make sure the towel bar assembly is fitted together securely.

Lift the towel bar assembly to the wall and align with the mounting posts.

Slip the towel bar assembly over the left and right mounting hardware posts.

Adjust the bar posts if necessary and secure by firmly tightening the set screws with the provided allen key.



## LIFETIME LIMITED WARRANTY

**SANTEC** is committed to enhancing your bathroom experience by creating luxury products that will provide enduring satisfaction. Every effort has been made to satisfy the highest standards of design and production to create lasting peace of mind for our customers. Proof of purchase must be provided for all warranty claims, SANTEC provides the following limited warranties on our product.

### LENGTH OF WARRANTY & WHO IS COVERED BY OUR WARRANTY

This warranty only extends to the original consumer purchaser.

### WHAT IS COVERED BY OUR WARRANTY

1. **Finishes:** SANTEC Polished Chrome, Polished Nickel and Satin Nickel finishes carry a Lifetime Limited warranty against manufacturing defects and tarnish to the original purchaser. Custom finishes carry a ten (10) years limited warranty against manufacturing defects and tarnish to the original purchaser only. Kitchen products carry a three (3) year limited warranty.
2. **Cartridges:** Santec cartridges carry a lifetime limited warranty, with the exception of thermostatic and pressure balanced cartridges, which carry a three (3) year limited warranty against manufacturing defects to the original purchaser.
3. **Parts:** Santec parts carry a ten (10) year limited warranty against manufacturing defects, to the original purchaser. Kitchen products carry a five (5) year limited warranty.

### EXCLUSIONS AND LIMITATIONS OF WARRANTY

This warranty does not cover:

1. **Drains**
2. **Crystals and/or glass**
3. Damage due to negligence, accident, abuse, improper installation, or improper maintenance such as, but not limited to: heat from soldering during installation, the use of plumber's putty, damage from tools used during installation, the use or exposure to chemicals or cleaning products either abrasive or non-abrasive, or the use of any cleaning tool or product other than a soft, clean cloth. Reverse osmosis may also shorten the life of the finish.
4. Changes in the finish or in the product due to normal wear or aging does not cover any products or parts which have been altered or used in a manner not typical for the product.
5. Loss, damages, or expense, incidental or consequential whatsoever, originating from the purchase, installation, use, repair, failure, or replacement of any SANTEC product or part, allowed by law.
6. Commercial and/or Industrial installations and use of the product.
7. This warranty does not include labor, travel charges, or any costs incurred for repair, removal, installation, servicing, diagnosing, or handling of either defective or replacement parts. Changes in the finish or in the product due to normal wear or aging does not cover any products or parts
8. Access should be provided to the roman tub valves for future service or repair to valves and piping. Under no circumstances will Santec Faucet, Inc. be liable for any costs associated with the removal of materials for future access to the tub valves or piping for service or repair.
- 9.

This warranty does not cover: damage due to negligence, accident, abuse, improper installation, or improper maintenance such as, (but not limited to): heat from soldering during installation, the use of plumbers putty, damage from tools used during installation, the use or exposure to chemical or cleaning products, abrasive or non-abrasive, or the use of any cleaning tool or product other than a soft, clean cloth. **This warranty does not cover: changes in the finish or in the product due to normal wear or again and does not cover any product or parts which have been altered or used in a manner not typical for the product.** Santec will not be held liable for damage to products caused by the freight carrier, any such claims should be made immediately with the freight carrier. This warranty does not cover any cost involved in the installation, repair, or replacement of any SANTEC product or parts. This warranty does not cover and SANTEC will not be held liable for any loss, damages, or expenses, incidental or consequential whatsoever, originating from the purchase, installation, use, repair, failure, or replacement of any SANTEC product or part, as allowed by law. The product of components of the covered product will either be repaired, refinished or replaced at the sole discretion of SANTEC. SANTEC reserves the right to examine any product claimed defective prior to any warranty claim being accepted or processed, at its sole discretion. This warranty gives you specific legal rights and you may have other rights which may vary from state to state.

Effective: 05/01/2015



## FINISH CARE INFORMATION

**WARNING:** Do not clean your SANTEC product with ammonia (window cleaner), bleach, soaps, acids, abrasives, harsh polishes, harsh cleaners, a coarse surfaced cloth, coarse sponge, or any type of scouring pad. Doing so may ruin your faucet finish and/or void the warranty.

Thank you for making SANTEC a part of your lifestyle and luxury spa experience. Our products have been created as works of enduring quality and sophisticated design. Luxurious finishes need proper care and attention, so in order to understand how to properly clean your distinctive luxury finish, please refer to the finish care information below:

Your SANTEC product can be identified in one of two categories: clear coated finishes or non-clear coated finishes. Clear coated finishes are more scratch-sensitive and are more reactant to harsh cleaning chemicals than non-clear coated finishes. Once you have identified the specific luxury finish of your SANTEC product, please follow the important corresponding care instructions.

**Living finishes are unique, are intended to change over time and are excluded from the finish warranty. Any product outdoors or in a marine environment are excluded from the finish warranty.**

### CLEAR COATED FINISHES

Clear Coated Finishes are as Follows:

We recommend that all faucets, drains, etc., be gently wiped dry with a soft cloth after use to avoid water spotting and water deposit build-up. A mild liquid hand soap may be used occasionally if desired. Use of a non-abrasive carnauba wax will add protection to the finish and should be used if the faucets will not be dried after use. Santec Orobrass kitchen products are clear coated. For clear coated finishes, it is recommended to clean your product weekly with a soft moist cloth.

### NON-CLEAR COATED FINISHES

We recommend that all faucets, drains, etc., be gently wiped dry with a soft cloth after use to avoid water spotting and water deposit build-up. A mild liquid hand soap may be used occasionally if desired. Use of a non-abrasive carnauba wax is occasionally required and will add protection to the finish if the faucets will not be dried after use.

### TO OBTAIN WARRANTY SERVICE

Please read 'WHAT IS COVERED BY OUR WARRANTY' and 'EXCLUSIONS AND LIMITATIONS OF WARRANTY' sections to understand what is and what is not covered. Please have ready the proof of purchase (original sales receipt), description of the problem, and carefully package the product or defective part with postage prepaid. Then, please contact your local SANTEC Showroom or write to SANTEC Technical Services.