



KEEP THIS INSTRUCTION BOOKLET FOR FUTURE REFERENCE

Important : Please register your product online at www.santecfaucet.com within 30 days of purchase. Santec reserves the right to request additional documents before servicing warranty requests.

PARTS BREAK DOWN



POST FLANGE WASHERS (2)

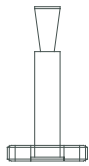

MOUNTING HARDWARE POSTS (2)

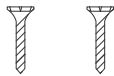
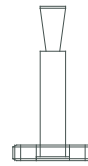

DRY WALL SCREWS (4)

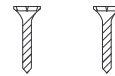

DRY WALL TOGGLES (4)

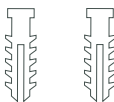

SOLID WALL ANCHORS (4)

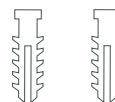

ALLEN KEY

Remove the Mounting Hardware Post from the Bar Posts and use them as references for positioning. Make sure that the Bar is level and the Bar Post positions are correct.

Installing On Wooden Surface

For wooden surface, the Mounting Hardware Posts can be secured by screwing the Screws directly into the wall.

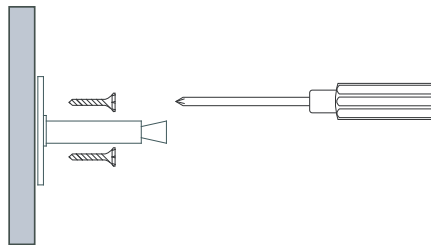

Installing On Drywall

Mark the four screw hole positions by using the Mounting Hardware Post.

Using a drill, pre-drill holes for the Toggles.

Fold the Toggle's leg and insert it into the wall.

The Mounting Hardware Posts can be secured by screwing the Screws into the Toggles.

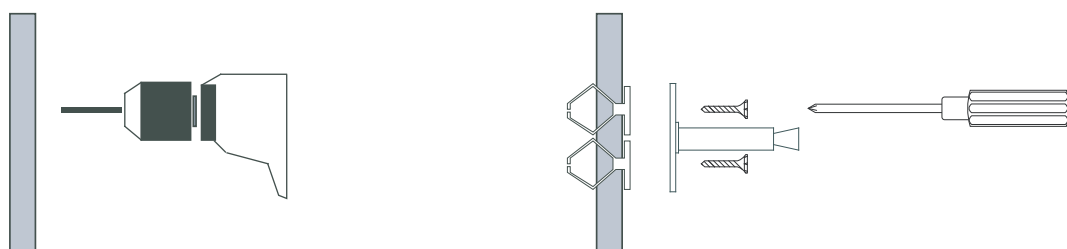

Towel Bar

Installing On Solid/Hard Surface

Measure the dimensions carefully, mark the four screw hole positions by using the Mounting Hardware Post.

Using a drill, pre-drill the holes.

Insert Anchors into the wall.

Secure the Mounting Hardware Posts by tightening the Screws into the Anchors.

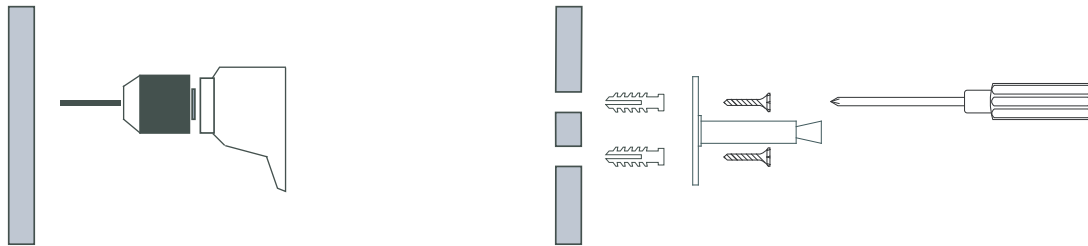

Measuring the Mounting Hardware Posts

At the wall, measure the 18", 24", or 30" distance from the center of the secured Mounting Hardware Post to where the other will go and mark the measurement with a pencil. Place the center of the other Mounting Hardware Post over the mark and check with a level to make sure the height of both is the same. When level and centered, mark the screw hole positions.

Follow the previous installation instructions to secure the second Mounting Hardware Post.

Towel Bar

Securing In Position

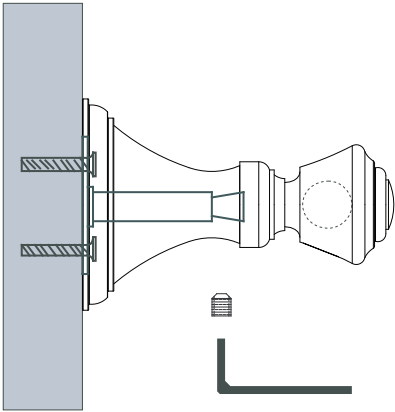

Using the Allen Key provided, loosen the Bar Posts' Set Screws.

Set the Bar Posts apart from each other onto a flat surface with openings facing each other and insert the Towel Bar into both left and right unsecured Bar Posts.

Make sure the towel bar assembly is fitted together securely.

Lift the towel bar assembly to the wall and align with the Mounting Posts.

Slip the towel bar assembly over the left and right Mounting Hardware Posts.

Adjust the Bar Posts if necessary and secure by firmly tightening the Set Screws with the Allen Key.

Check both Bar Posts to make sure they are firmly secured. If not completely secured, tighten the Set Screw a bit more with the Allen Key.



FINISH CARE INFORMATION

WARNING: Do not clean your SANTEC product with ammonia (Window cleaner), bleach, soaps, acids, abrasives, harsh polishes, harsh cleaners, a coarse surfaced cloth, coarse sponge, or any type of scouring pad. Doing so may ruin your faucet finish and/or void the warranty.

Thank you for making SANTEC a part of your lifestyle and luxury spa experience. Our products have been created as works of enduring quality and sophisticated design. Luxurious finishes need proper care and attention, so in order to understand how to properly clean your distinctive luxury finish please refer to the Finish Care Information below:

Your SANTEC product can be identified in one of two categories: clear coated finishes or non-clear coated finishes. Clear coated finishes are more scratch-sensitive and are more reactant to harsh cleaning chemicals than non-clear coated finishes. Once you have identified the specific luxury finish of your SANTEC product, please follow the important corresponding care instructions.

CLEAR COATED FINISHES

Polished & Satin 24K Gold : The Karat mark states the percentage of pure gold – 24K is 100 percent gold. As one of the Earth's most precious metals, gold is the most supple and malleable of all metals. Gold-plated faucets scratch easily. To clean, wipe down with a dry soft cloth after each use. Gold surfaces should be coated with a thin layer of non-abrasive carnaub wax or liquid car wax up to 3 or 4 times per year. This will prevent water spotting and water deposit buildup. We recommend using SANTEC's Polish which has been formulated to clean and seal, leaving behind a protective coating that will resist tarnishing and improve water repellency.

Antique Bronze : Antique bronze simulates the antiquity of Old-World craftsmanship with a golden base color and a blend of dark undertones. To clean, wipe down with a dry soft cloth after each use. Antique Bronze should be coated with a thin layer of non-abrasive carnauba wax or liquid car wax up to 3 or 4 times per year. We recommend using SANTEC's Polish which has been formulated to clean and seal, leaving behind a protective coating that will resist tarnishing and improve water repellency.

Oil Rubbed Bronze : Oil-rubbed bronze simulates the antiquity of Old-World craftsmanship with its warm, dark brown color and copper undertones. To clean, wipe down with a dry soft cloth after each use. Oil-rubbed bronze should be coated with a thin layer of non-abrasive carnauba wax or liquid car wax up to 3 or 4 times per year. We recommend using SANTEC Polish which has been formulated to clean and seal, leaving behind a protective coating that will resist tarnishing and improve water repellency.

NON-CLEAR COATED FINISHES

Polished Chrome : Chrome plating is extremely reflective, with a rich bluish luster. To clean, wipe down with a dry soft cloth after each use. A non-abrasive all-metal cleaner can then be applied to restore the shine. The surface can also be coated with a thin layer of non-abrasive carnauba wax or liquid car wax. This will prevent water spotting and water deposit buildup. We recommend using SANTEC's Polish which has been formulated to clean and seal, leaving behind a protective coating that will resist tarnishing and improve water repellency.

Polished and Satin Nickel : To clean, wipe down with a dry soft cloth after each use. A non-abrasive all-metal cleaner can then be applied to restore the shine. The surface can also be coated with a thin layer of non-abrasive carnauba wax or liquid car wax. This will prevent water spotting and water deposit buildup. We recommend using SANTEC's Polish which has been formulated to clean and seal, leaving behind a protective coating that will resist tarnishing and improve water repellency.

PLEASE REGISTER YOUR PRODUCT ONLINE FOR WARRANTY SERVICES
www.santecfaucet.com/registration



LIFETIME LIMITED WARRANTY

SANTEC is committed to enhancing your bathroom experience by creating luxury products that will provide enduring satisfaction. Every effort has been made to satisfy the highest standards of design and production, to create lasting peace of mind for our customers. We provide the following limited warranties on our products:

LENGTH OF WARRANTY & WHO IS COVERED BY OUR WARRANTY

This warranty extends to the original consumer purchaser only and extends for as long as the original purchaser owns the product and the home in which the product is installed.

WHAT IS COVERED BY OUR WARRANTY

1. **Finishes:** Santec Polished Chrome, Polished Nickel and Satin Nickel finishes carry a Lifetime Limited warranty against manufacturing defects and tarnish to the original purchaser with the exclusion of kitchen drain assemblies which, due to the nature of their use, are not warranted. Santec recommended custom finishes carry a ten (10) years limited warranty against manufacturing defects and tarnish to the original purchaser with the exclusion of kitchen and pop-up drain assemblies which, due to the nature of their use, are not warranted. Kitchen products carry a three (3) year limited warranty.
2. **Cartridges:** Santec Cartridges carry a lifetime limited warranty against manufacturing defects for the life of the product to the original purchaser.
3. **Parts:** Santec parts carry a ten (10) year limited warranty against manufacturing defects, to the original purchaser. Kitchen products carry a five (5) year limited warranty.

EXCLUSIONS AND LIMITATIONS OF WARRANTY

This warranty does not cover:

1. Damage due to negligence, accident, abuse, improper installation, or improper maintenance such as, but not limited to: heat from soldering during installation, the use of plumber's putty, damage from tools used during installation, the use or exposure to chemicals or cleaning products either abrasive or non-abrasive, or the use of any cleaning tool or product other than a soft, clean cloth. Reverse osmosis may also shorten the life of the finish.
2. Changes in the finish or in the product due to normal wear or aging does not cover any products or parts which have been altered or used in a manner not typical for the product.
3. Loss, damages, or expense, incidental or consequential whatsoever, originating from the purchase, installation, use, repair, failure, or replacement of any SANTEC product or part, allowed by law.
4. Commercial and/or Industrial installations and use of the product.
5. This warranty does not include labor, travel charges, or any costs incurred for repair, removal, installation, servicing, diagnosing, or handling of either defective or replacement parts.

The product or components of the covered product will be repaired, refinished, or replaced, at the sole discretion of SANTEC. SANTEC reserves the right to examine any product claimed defective prior to any warranty claim being accepted or processed, at its sole discretion. This warranty gives you specific legal rights and you may have other rights which may vary from state to state.

TO OBTAIN WARRANTY SERVICE

Please read 'WHAT IS COVERED BY OUR WARRANTY' and 'EXCLUSIONS AND LIMITATIONS OF WARRANTY' sections to understand what is and what is not covered. Please have ready the proof of purchase (original sales receipt), description of the problem, and carefully package the product or defective part with postage prepaid. Then, please contact your local SANTEC Showroom or write to SANTEC Technical Services.

Access should be provided to the roman tub valves for future service or repair to valves and piping. Under no circumstances will Santec Faucet, Inc. be liable for any costs associated with the removal of materials for future access to the tub valves or piping for service or repair.