

Plan
14901010600 Towel rail

PRODUCT

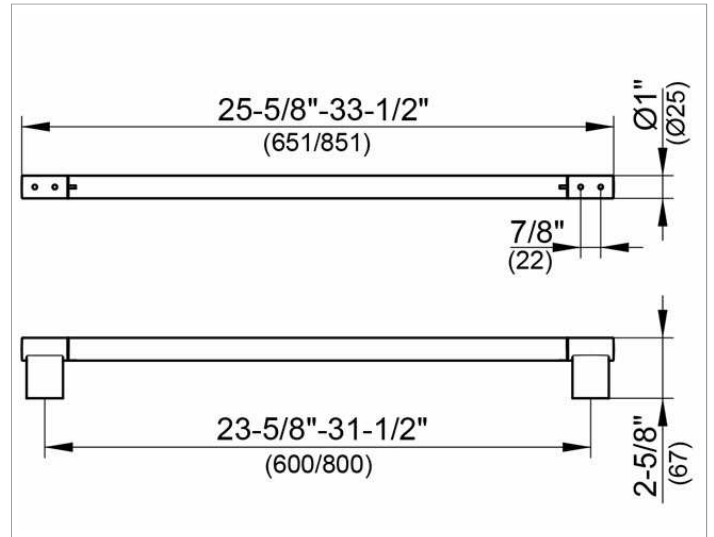

DRAWING



SURFACE

chrome-plated

DIMENSION

23,62 "

SPECIFICATIONS

KEUCO PLAN towel rail 14901010600
 Chrome-plated towel rail, in a stylish yet functional design
 anti static, easy to clean
 Centre to centre 23-5/8" with overall width of 25-5/8"
 Depth 2-5/8"
 The towel rail is fitted with 4 hidden fixing points
 incl. corrosion-free mounting material

Warranty: KEUCO products are covered by a 5-year manufacturer's warranty, in effect from the date of purchase. During this time, proven product defects will be remedied free of charge. Warranty claims must be filed in writing, including a detailed description of the defect immediately after a defect has occurred. For a copy of our detailed product warranty policy, please contact us at office-usa@keuco.com.

Installation: KEUCO products must be installed by a qualified professional in accordance with the respective installation guidelines and any applicable federal / local building codes and regulations.