

GROHE

WATER TECHNOLOGY

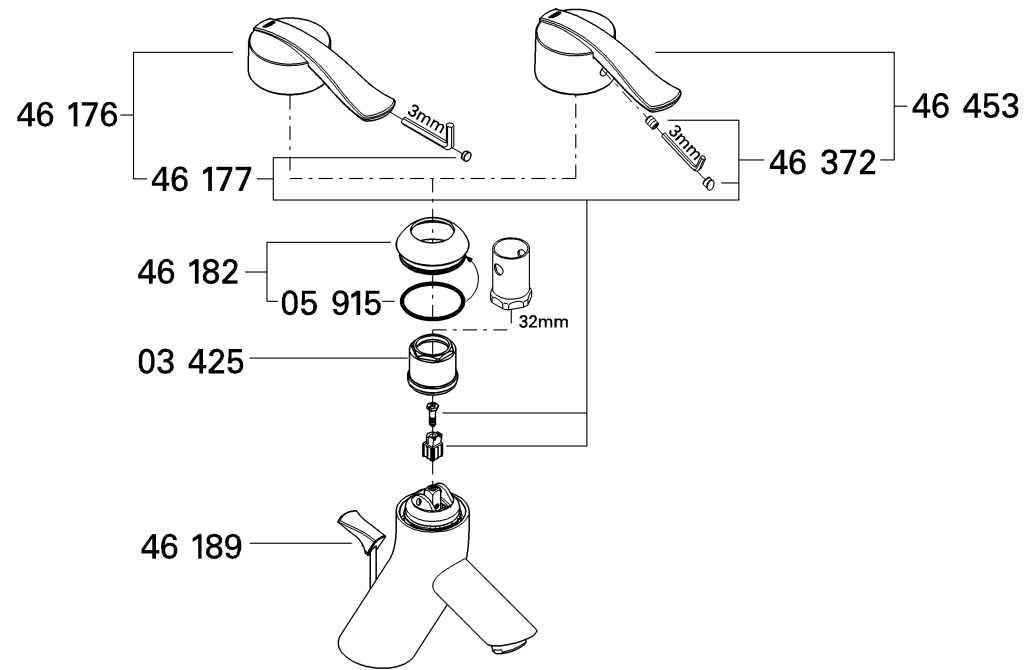

95.096.131/ÄM 30 236/05.02