

GROHE

WATER TECHNOLOGY

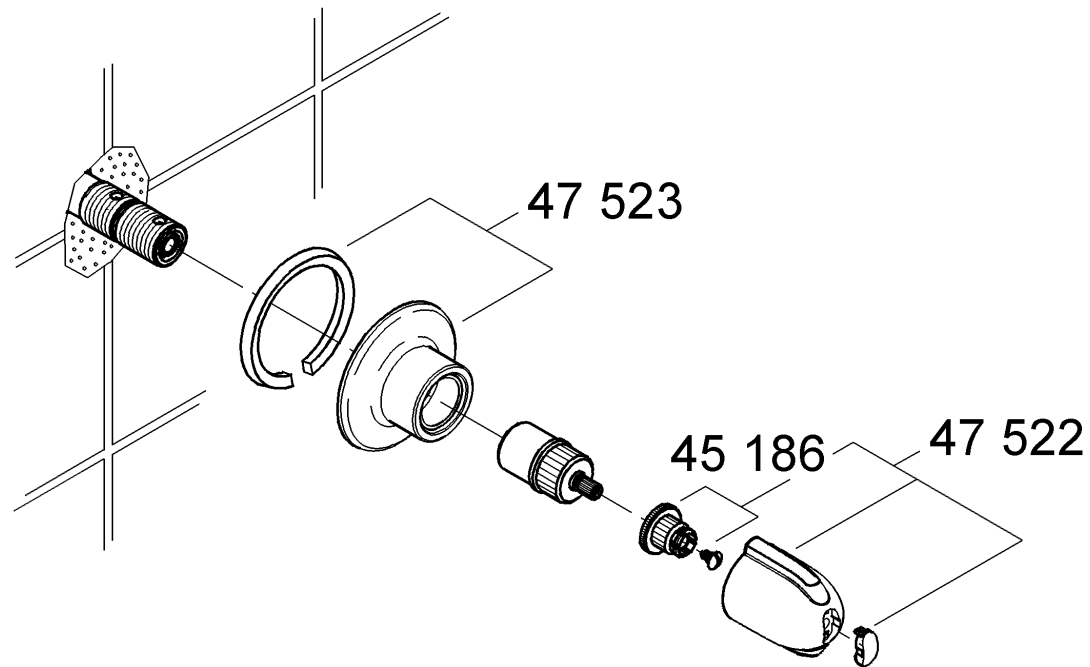

97.614.131/ÄM 30 221/06.01