

GROHE

WATER TECHNOLOGY

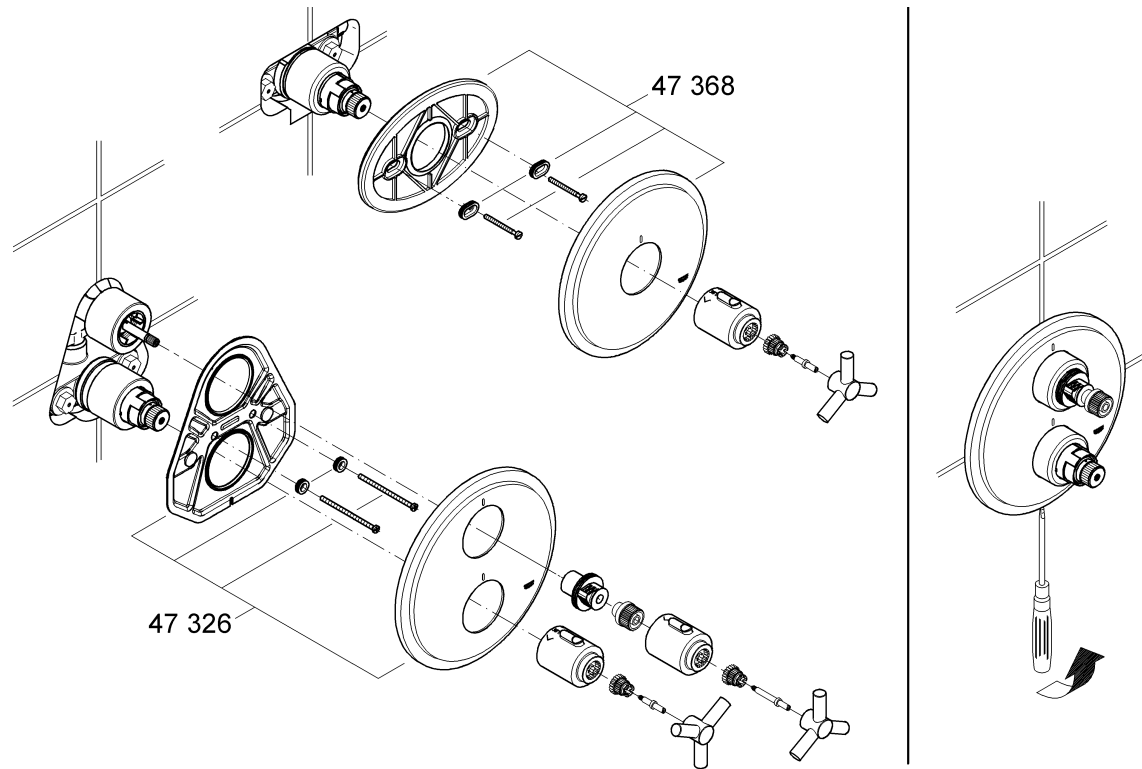

95.938.131/ÄM 30 290/02.02