

42 340
42 341

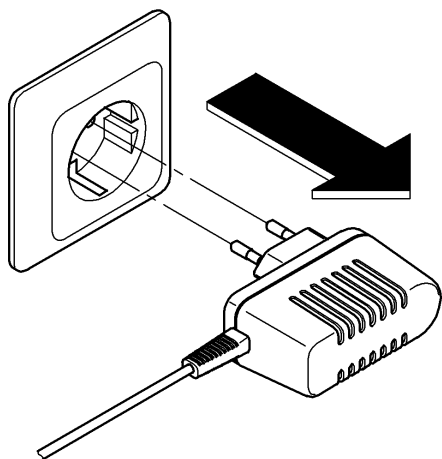

1.

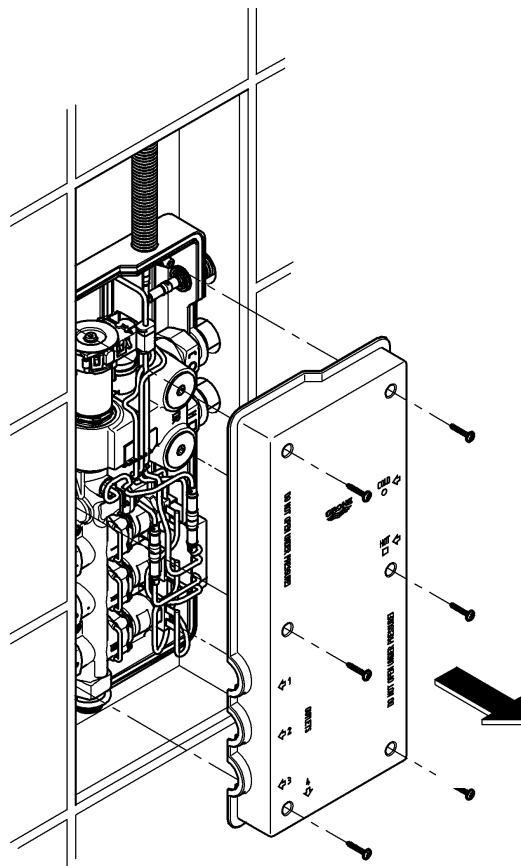

2.

42 341

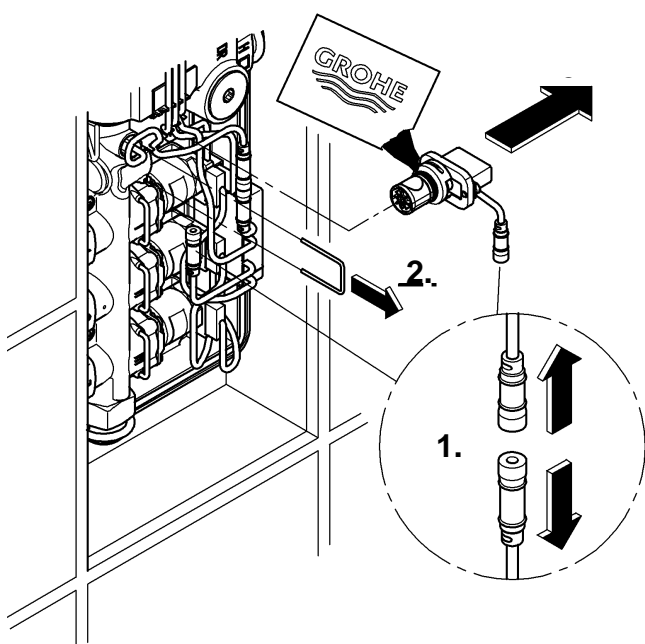

3a.

42 340

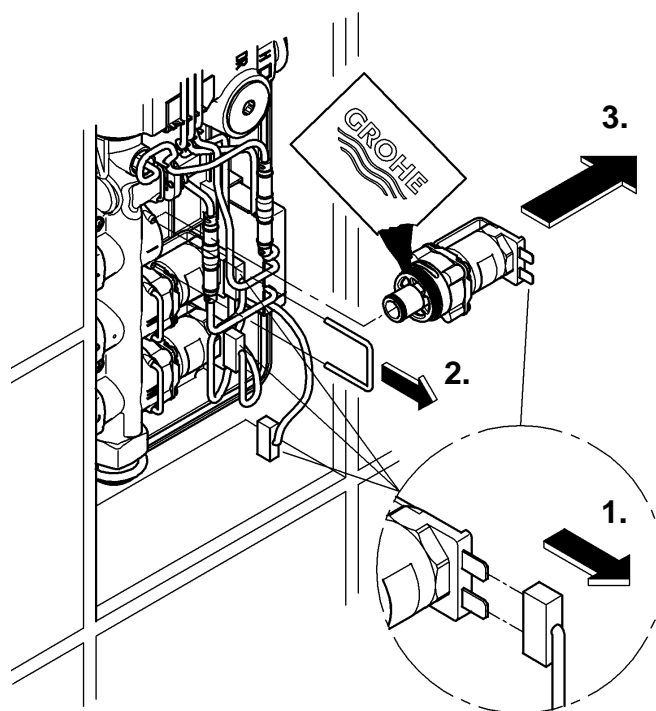

3b.