

67" NAIROBI ACRYLIC DOUBLE SLIPPER TUB

Cat. No.
ATDSN67MIG-XXXX



L: 67"
W: 31-1/4"
H: 28-5/8" top, 23-1/4" center

Water depth: 17-1/2" to top of tub
Water depth: 15" to overflow
Overflow slot diameter: 1/2" x 2-3/4"
Bottom drain to back of rim: 15-1/2"
Bathing well to floor: 5-3/8"
Bottom of drain to floor: 4-3/8"
Sitting area: 18"
Bottom of tub: 47-1/2" x 19-3/4"

**The following is recommended for
ATDSN67MIG tubs:**

- Faucet: part #7020, #7082, #7088
- Double offset supplies: part #5576
- Freestanding Filler: part #7901, 7922, or 7934
(Supplies included with filler)



**For easier installation we
recommend use of 5598-ITD
Easy Install Rough In Kit**

Gallon Capacity: 69
Shipping Weight: 124 lbs.
Empty Weight: 99 lbs.
Filled Weight: 671 lbs.

Features:

- ▶ Acrylic construction for lighter weight
- ▶ Rim measurement: 1-1/4"
- ▶ No faucet hole
- ▶ Overflow slot with integrated drain
- ▶ Drain included
- ▶ Includes built-in adjusters
- ▶ Angle slope of tub: 66°
- ▶ Drain and overflow covers included (available in 8 finishes)
- ▶ Tub is thoroughly inspected before shipment
- ▶ Option to add foam insulation between tub walls available
- ▶ New: Air jet system now available, more info on page 2
- ▶ Interior will always be white
- ▶ **Tub exterior colors: White, Matte White, or Matte Black**



Finish:

BN	Brushed Nickel	WT	Matte White
CP	Polished Chrome	PN	Polished Nickel
MB	Matte Black	WH	White
ORB	Oil Rubbed Bronze	BGD	Brushed Gold

Custom Colors Available (inside of tub is always white enamel);
Painted bathtubs are considered "special order" and are not returnable

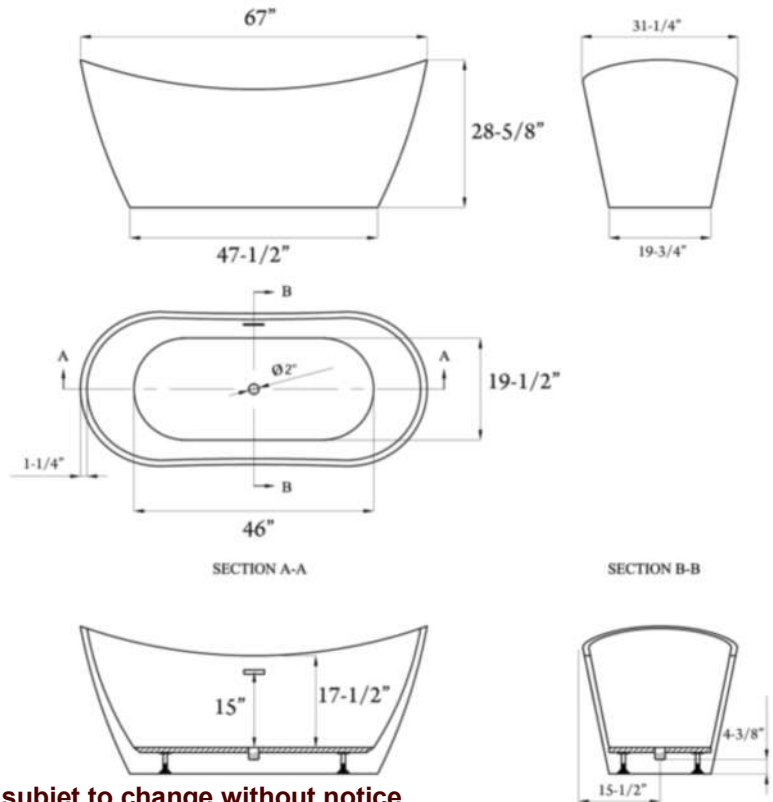

Dimensions of fixture are nominal and specifications subject to change without notice.

BATHTUB AIR JET KIT

Cat. No.
AIR KIT 1, AIR KIT 2

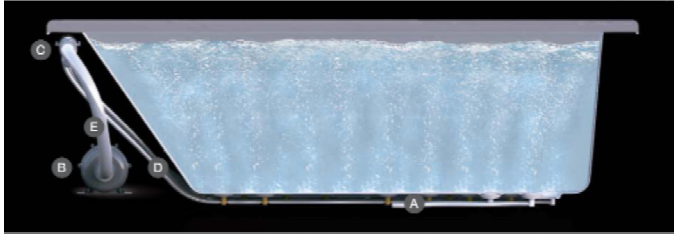

- A** AIR JET - Bottom air jets for maximum bubble action.
- B** BLOWER - The heart of the massage system.
- C** MANIFOLD - Double back flow security prevention device.
- D** FLEXIBLE PVC HOISING - IAPMO certified.
- E** MAIN AIR INTAKE HOSE - High temperature and pressure resistant.

Air Kit is installed in tub before shipment

Features:

- ▶ 750 Watt blower motor operates system
- ▶ 300 Watt air heater warms air
- ▶ System powered by 120V
- ▶ 16 brass air jets placed in bottom of tub
- ▶ Each air jet has 24 holes
- ▶ Air jet caps available in white (AIR KIT 1) or black (AIR KIT 2)
- ▶ Includes 1¼" x 3' main air hose plus 1¼" x 9' extension hose
- ▶ Automatic system purge after each use
- ▶ Automatic safety timer turns off system after 20 minutes
- ▶ Includes water tight remote control
- ▶ Compatible with most acrylic, copper and resin tubs with no feet
- ▶ Not available with cast iron tubs or tubs with feet

INSIDE TUB VIEW - WILL VARY BY TUB DESIGN



Air Jet



Remote

Oval bathtub
Sample jet configuration

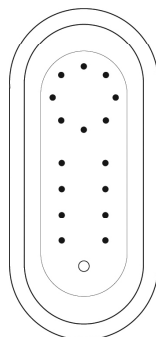

with end drain

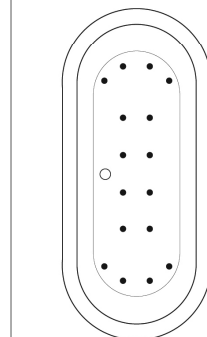

with center drain

Rectangular bathtub
Sample jet configuration

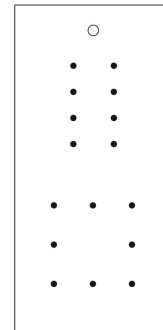

with end drain

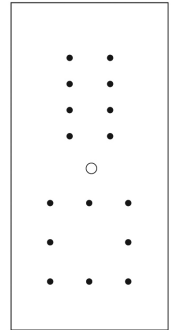

with center drain

Round bathtub
Sample jet configuration

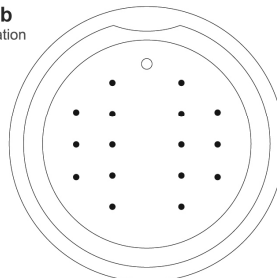

These diagrams are general representations.
Jet placement may vary dependent on tub shape

Features:

(16) Maxi Air Jets



Elbows for air jets



Tees for air jets