

**ASSEMBLY INSTRUCTION****4UHO2****30" Slide Bar with Fixed Shower Head,  
Adjustable Hand Held Shower & Diverter****4UHO2****REMOVAL OF FAUCET:**

Always turn the water supply off before removing the existing faucet or disassembling a valve. Open both faucet handles to relieve water pressure and to ensure that the water has been successfully turned off.

**CARE OF FAUCET:**

The use of warm water and a soft cloth is all that is required to clean Rubinet products. The patina of our living finishes (Oil Rubbed Bronze & Tuscan Brass) will change as a result of normal use. Applying Mineral Oil on occasion will create a softer look, subtle color changes and character.

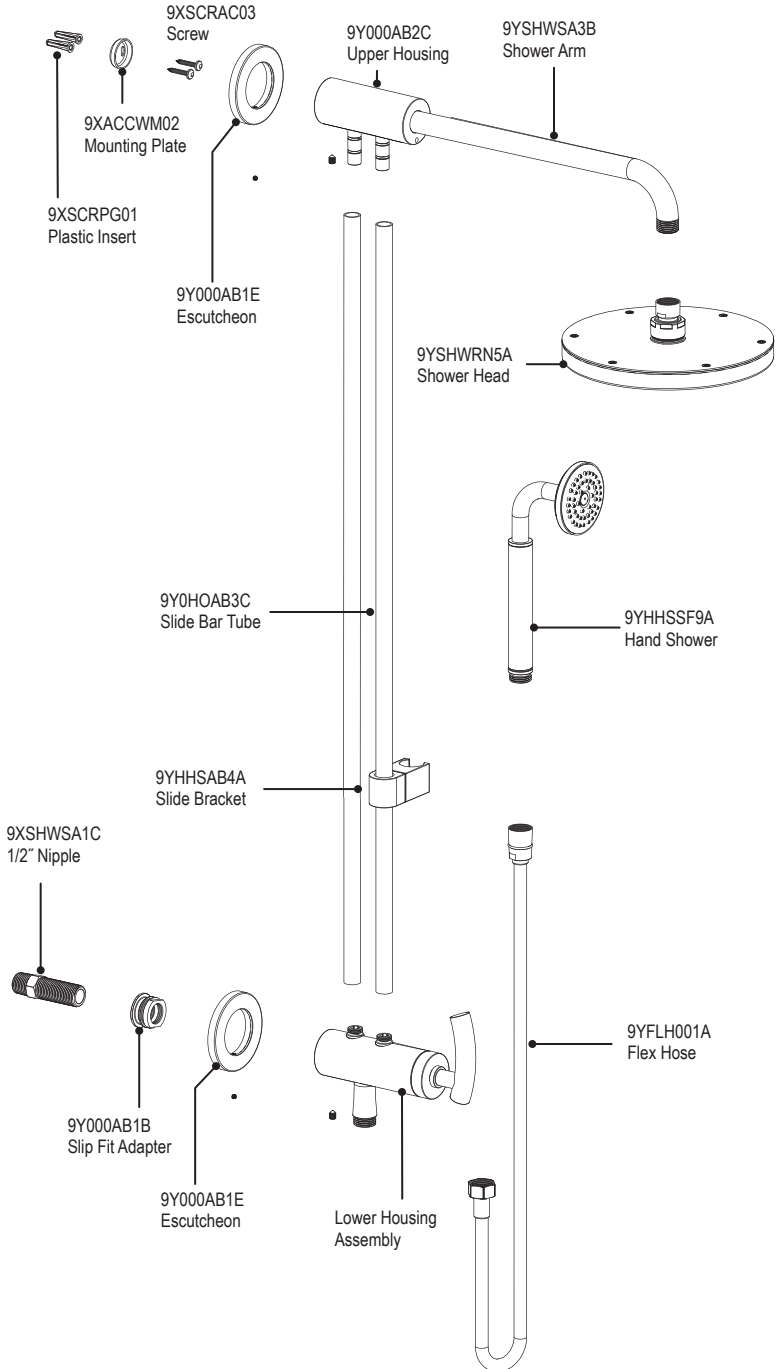

1

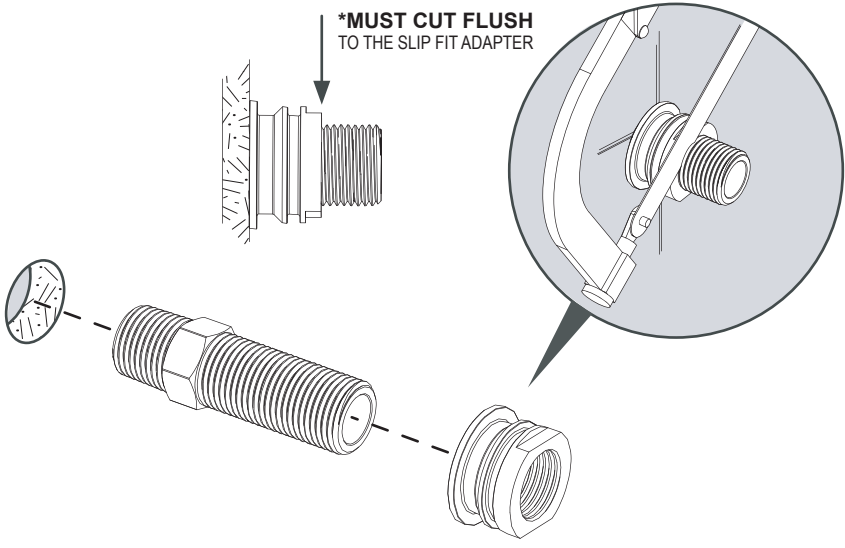

2

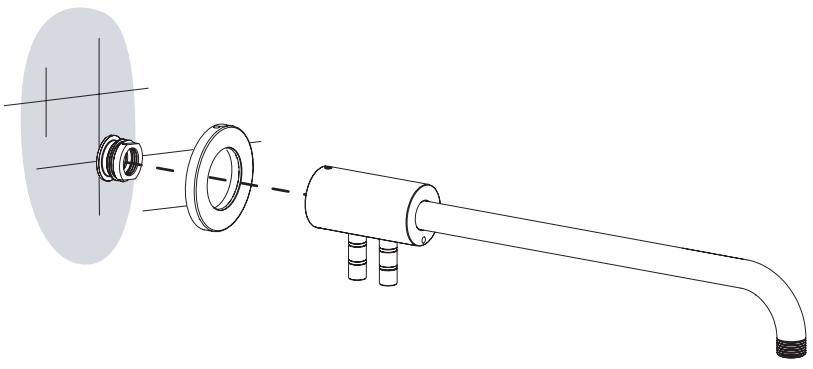

3

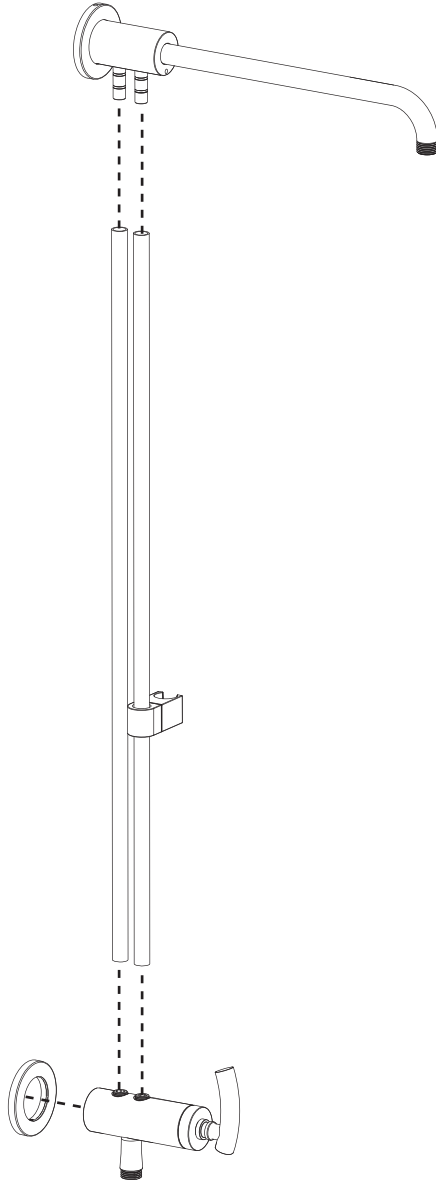

\* Do not tighten set screws for Slide Bar adjustment later.

4

4

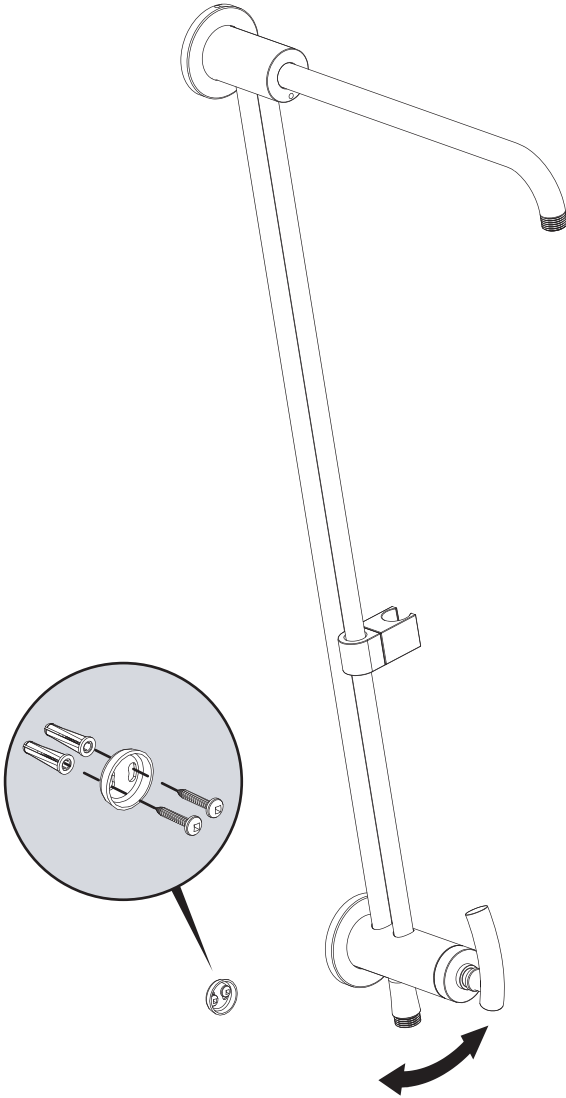

5

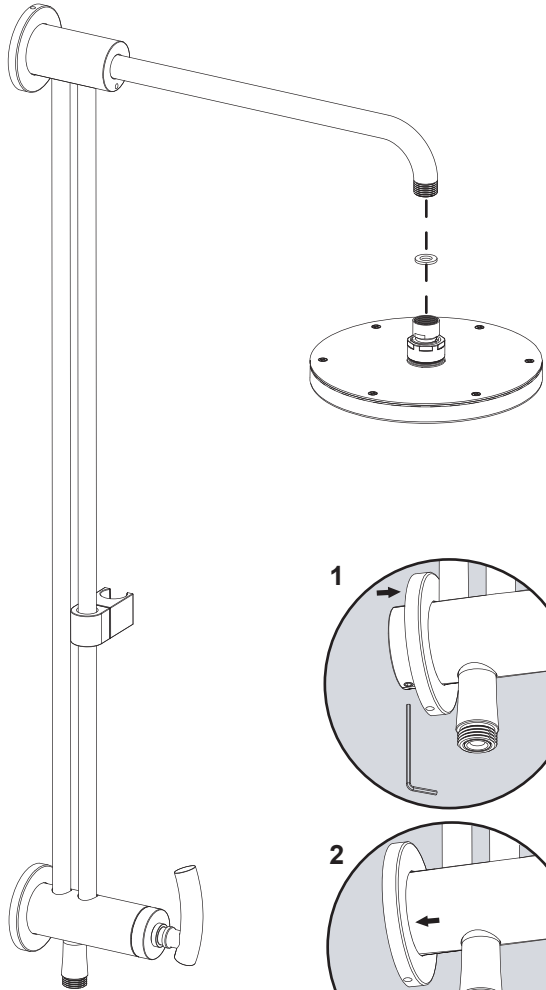
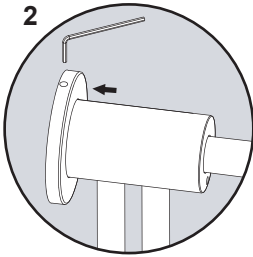
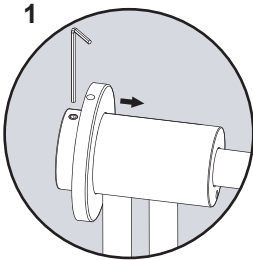

\* Tighten all set screws before installing Shower Head

6

6

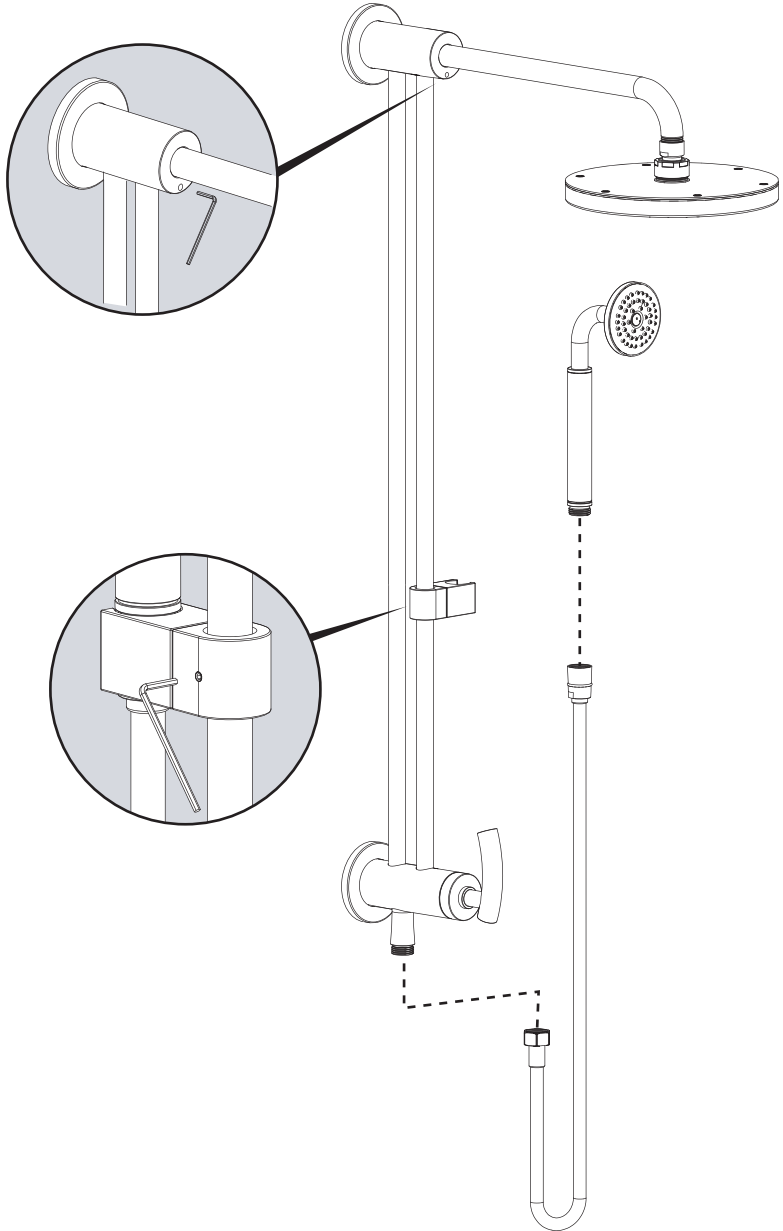

**FEATURES:**

- Brass construction with choice of 21 finishes
- Requires tempered water supply
- Fixed Shower Head & Adjustable Hand Held Shower
- Quarter turn diverter mechanism
- 2.5 gpm @ 60 psi

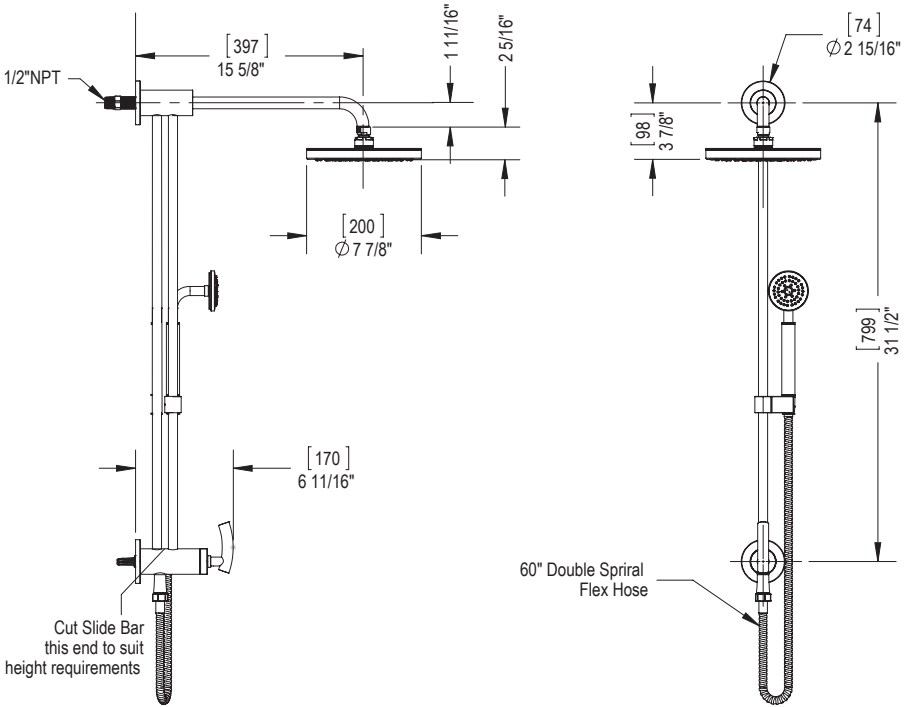

**CONTACT US:**

If you need assistance with installation, replacement parts or have any questions regarding your Rubinet product, please call a Customer Service representative at: 905-851-6781 toll free 1-800-461-5901 or visit [www.rubinet.com](http://www.rubinet.com)