

Go to tsicustomerservice.com for product warranty registration

ASSEMBLY INSTRUCTIONS

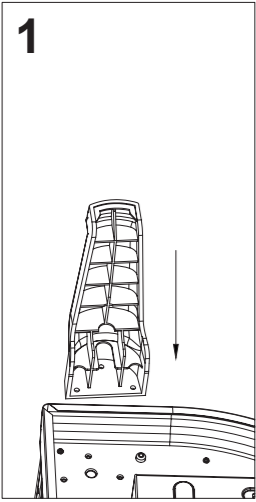

1

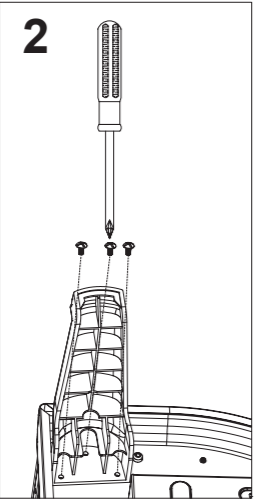

2

MOUNTING THE LEGS

- 1) Align the mounting tab into the bracket and lower the leg into place.
- 2) Fasten the leg to the bracket using the included screws, 3 per leg.

OPERATING INSTRUCTIONS

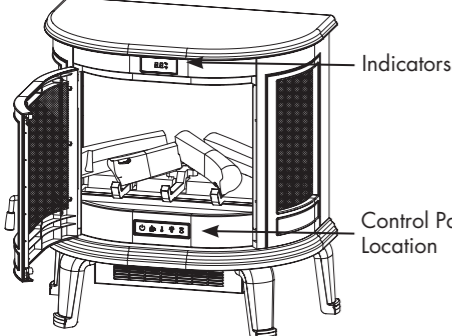

Indicators

Control Panel Location



Remote Control

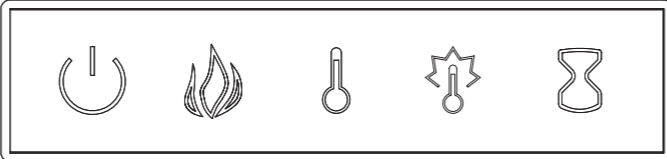

Control Panel

OPERATING INSTRUCTIONS

- POWER**
1. The power button supplies power to all of the fireplace functions. The power button will put the insert in a standby mode. This will turn off all functions at once, but will hold the settings in the memory. By pressing the Power button again, the unit will turn on with the retained settings.
 2. With the power on, press and hold the Power button on the control panel for 10 seconds to disable or re-enable the heater function. Once disabled or re-enabled, the ember bed lights will flash multiple times.
- FLAME**
1. There are 5 brightness levels that can be selected and OFF (00) setting.
 2. Settings F5 - F1 decrease in brightness.
- HEATER**
1. The stove contains a fan forced infrared element heater.
 2. The thermostat setting range is 62°F - 82°F (17°C - 27°C) or continuously ON or OFF(00).
 3. The thermostat is adjustable by 2°F or 1°C increments by pressing the HEATER button on the control panel.
 4. To change between °F and °C press and hold the HEATER button on the control panel for 3 seconds.
 5. The up and down buttons " ^ / v " on the remote will increase/decrease temperature setting.
- TIMER**
1. Pressing the timer button will cycle through the timer settings: 30 minutes, 1 Hour, 2H, 3H, 4H, 5H, 6H, 7H, 8H, 9H and off (00).
- HEATER BOOST**
1. Press this button to turn on/off heater boost. "HI" will appear on the display when it is on and will not display while it is off. Default setting is off.

Manufactured and distributed by Twin-Star International, Inc., under license from Durafame, Inc. durafame, the flame symbol and logo are registered trademarks of Durafame, Inc.

Twin-Star International, Inc.
Delray Beach, FL 33445

PRODUCT SPECIFICATIONS

VOLTAGE	120 VAC, 60 Hz
AMPS	12.5 Amps
WATTS	1500 Watts

For Customer Service:

tsicustomerservice.com
(+1) 888-674-7517
8:30 a.m.-5:30 p.m., EST, Monday-Friday

Note: When first running the heater there may be an odor. This is normal as the heater has a surface coating on the internal parts. For the first several hours of operation, the coating reacts with the internal parts to permanently protect them. The odor is safe; if you are sensitive to the odor, it is recommended to run the heater in a well-ventilated area until the odor dissipates.

Warning: This is an unvented, electric appliance. DO NOT attempt to burn wood or manufactured firelogs in or on this appliance or grate.

© 2019, Twin-Star International, Inc.
Delray Beach, FL 33445

IMPORTANT INSTRUCTIONS

When using electrical appliances, basic precautions should always be followed to reduce the risk of fire, electrical shock, and injury to persons including the following:

1. Read all instructions before using this appliance.
2. This appliance is hot when in use. To avoid burns, do not let bare skin touch hot surfaces. If provided, use handles when moving this appliance. Keep combustible materials, such as furniture, pillows, bedding, papers, clothes and curtains at least 3 feet (0.9 m) from the front of this appliance and keep away from the sides and the rear.
WARNING: In order to avoid overheating, do not cover the heater.
3. CAUTION: Never leave the heater operating unattended. Extreme caution is necessary if unsupervised children or invalids are nearby.
4. The appliance is not to be used by children or persons with reduced physical, sensory or mental capabilities, or lack of experience and knowledge, unless they have been given supervision or instruction.
5. Always unplug this appliance when not in use.
6. Do not operate any heater with a damaged cord or plug or after the appliance malfunctions, or if it has been dropped or damaged in any manner.
7. If the supply cord is damaged, it must be replaced by the manufacturer, its service agent or similarly qualified persons in order to avoid a hazard.
8. Do not use outdoors.
9. This heater is not intended for use in bathrooms, laundry areas and similar indoor locations. Never locate this appliance where it may fall into a bathtub or other water container.
10. Do not run cord under carpeting. Do not cover cord with throw rugs, runners, or similar coverings. Do not route cord under furniture or appliances. Arrange cord away from traffic area and where it will not be tripped over.
11. To disconnect this appliance, turn controls to the off position, then remove plug from outlet.
12. Do not insert or allow foreign objects to enter any ventilation or exhaust opening as this may cause an electric shock or fire, or damage the appliance.
13. To prevent a possible fire, do not block air intakes or exhaust in any manner. Do not use on soft surfaces, like a bed, where opening may become blocked.
14. This appliance has hot and arcing or sparking parts inside. Do not use it in areas where gasoline, paint or flammable liquids are used or stored. This stove should not be used as a drying rack for clothing. Christmas stockings or decorations should not be hung in the area of it.
15. Use this appliance only as described in the manual. Any other use not recommended by the manufacturer may cause fire, electric shock or injury to persons.
16. This appliance, when installed, must be electrically grounded in accordance with local codes or, in the absence of local codes, with the current CSA C22.1 Canadian Electrical Code or for U.S.A. installations, follow local codes and the National Electrical Code, ANSI/NFPA NO.70.
17. This product is equipped with a polarized plug (one blade is wider than the other blade). To reduce the risk of electrical shock, this plug will fit into a polarized outlet only one way. This is a safety feature. If you are unable to insert the plug into the electrical outlet, try reversing the plug. If the plug still does not fit, contact a qualified electrician. Avoid the use of an extension cord because the extension cord may overheat and cause risk of fire. However, if you have to use an extension cord, the cord must be No.14 AWG minimum size and rated not less than 1875 Watts. The extension cord must be a three wire cord with grounding type plug and cord connection. The extension cord shall not be more than 20 feet (6 m) in length.
18. This heater may include a visual alarm to warn that parts of the heater are getting excessively hot. If the alarm flashes immediately turn the heater off and inspect for any objects on or adjacent to the heater that may cause high temperatures.
DO NOT OPERATE THE HEATER WITH THE ALARM FLASHING!

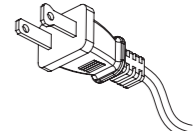

Battery Replacement

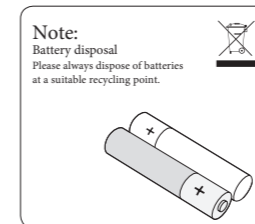
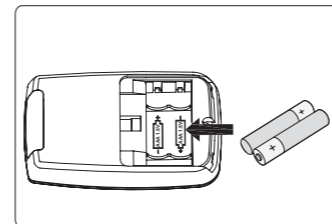

Note:
Battery disposal
Please always dispose of batteries at a suitable recycling point.

1. The battery compartment is located on the back end of the remote control.
2. Press and slide the battery door open and remove the old battery.
3. Insert 2 AAA batteries, checking that the + and - sides of the battery match inside the battery compartment.
4. Replace the battery compartment door.

Caution:

- For best results, use 2pcs AAA alkaline batteries.
- Install only new batteries of the same type in your product.

1-YEAR LIMITED WARRANTY

The manufacturer warrants that your new Electric Stove is free from manufacturing and material defects for a period of one year from date of purchase, subject to the following conditions and limitations.

1. Install and operate this Electric Stove in accordance with the installation and operating instructions furnished with the product at all times. Any unauthorized repair, alteration, willful abuse, accident, or misuse of the product shall nullify this warranty.
2. This warranty is non-transferable, and is made to the original owner, provided that the purchase was made through an authorized supplier of the product.
3. The warranty is limited to the repair or replacement of part(s) found to be defective in material or workmanship, provided that such part(s) have been subjected to normal conditions of use and service, after said defect is confirmed by the manufacturer's inspection.
4. The manufacturer may, at its discretion, fully discharge all obligations with respect to this warranty by refunding the wholesale price of the defective part(s).
5. Any installation, labor, construction, transportation, or other related costs/expenses arising from defective part(s), repair, replacement, or otherwise of same, will not be covered by this warranty, nor shall the manufacturer assume responsibility for same.
6. The owner/user assumes all other risks, if any, including the risk of any direct, indirect or consequential loss or damage arising out of the use, or inability to use the product, except as provided by law.
7. All other warranties – expressed or implied –with respect to the product, its components and accessories, or any obligations/liabilities on the part of the manufacturer are hereby expressly excluded.
8. The manufacturer neither assumes, nor authorizes any third party to assume on its behalf, any other liabilities with respect to the sale of the product.
9. The warranties as outlined within this document do not apply to non accessories used in conjunction with the installation of this product.
10. This warranty gives you specific legal rights, and you may also have other rights which vary from state to state.

This warranty is void if:

- a. The fireplace is subjected to prolonged periods of dampness or condensation.
- b. Any unauthorized alteration, willful abuse, accident, or misuse of the product.
- c. You do not have the original receipt of purchase.

IF WARRANTY SERVICE IS NEEDED

Contact the manufacturer by calling customer service department at 1-888-674-7517, 7 days a week 24 hours a day at our toll-free help line. Our Consumer Service department is available Monday – Friday 8:30 am – 5:30 pm EST. Make sure you have your warranty, your sales receipt, location of purchase and the model/serial number of your product.

- Failure to insert batteries in the correct polarity, as indicated in the battery compartment, may shorten the life of the batteries or cause batteries to leak.
- Do not mix old and new batteries.
- Do not mix Alkaline, Standard (Carbon-Zinc) or Rechargeable (Nickel Cadmium) or (Nickel Metal Hydride) batteries.
- Danger of explosion if battery is incorrectly replaced.
- Do not ingest batteries.
- Batteries should be recycled or disposed of as per state and local guidelines.

DISPOSAL OF USED BATTERIES

Battery may contain hazardous substances which could endanger the environment and human health. Used batteries shall not be treated as municipal waste, but left at the appropriate collection point for recycling. For more information about collection and recycling of used batteries, please contact your local municipality or waste disposal service.

SAVE THESE INSTRUCTIONS

Decorative back panel Instructions

The decorative chevron or fieldstone pattern back panel can be removed if you prefer a standard black back panel.

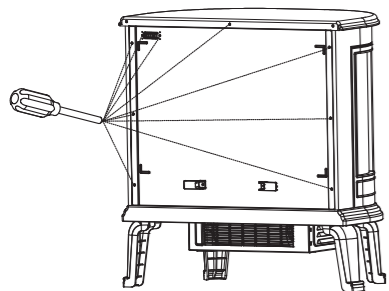

1. Unscrew 9 screws holding the back panel.

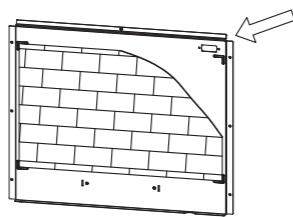

2. Remove the metal back panel from the unit and simply peel off the decorative brick pattern.

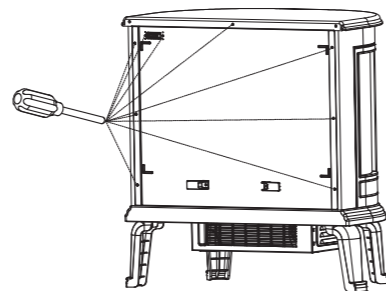

3. Secure the back panel with 9 screws.

TROUBLESHOOTING GUIDE

Problem	Root Cause	Corrective Action
1. Display shows "E1"	1. The thermostat sensor is broken or disconnected.	1. Unplug the stove, remove the back panel of the stove and check that the thermostat is plugged into the main circuit board. If this does not solve the problem contact customer service for a replacement thermostat sensor.
2. Display shows "E2"	2. The thermostat sensor is broken.	2. Contact customer service for a replacement thermostat sensor.
3. Display shows "E3"	3. Manual Reset overheat protection has triggered.	3. Inspect the heater and check that the air inlets and outlets are not blocked as this may cause overheating. Unplug the heater for 30 minutes and allow it to cool down. Replug and operate, but monitor the heater for signs of overheating. If the problem persists discontinue use of the heater and contact customer service.
4. No power, buttons do not light up.	4. Power cord was not plugged into the outlet.	4. Check that unit is plugged directly into a standard 120 volt outlet.
5. Stove does not turn on manually.	5a. No incoming power from the electrical wall socket or buttons. 5b. Improper operation. 5c. Defective button	5a. Check circuit breakers and move unit to another outlet. 5b. Manually press main power button from front of unit. 5c. Replace control panel circuit board.
6. Flames are not moving.	6a. Defective flame generator drive motor. 6b. Spinner detached from the motor.	6a. Replace flame generator drive motor. 6b. Remove the back panel/ emberbed/ metal bracket and check to see if "spinner" is correctly mounted to the motor.
7. Logs glow, but no flame effect.	7. Flame effect turned off	7. Press flame button several times.
8. Heater does not blow warm air.	8. Thermostat setting is preventing heater from turning on.	8. Adjust the temperature settings to ensure that the thermostat is set higher than the current room temperature.
9. Heater is not turning on.	9a. Improper operation 9b. Defective heater/blower assembly.	9a. Manually press main power button on front of unit. 9b. Replace heater/blower assembly.
10. Not producing enough heat.	10a. Power strip/surge protector/ extension cord being used 10b. Location of unit.	10a. Plug unit directly into the wall. 10b. Make sure unit is located on an interior wall.
11. Unit blows cool or cold air.	11. Defective heater blower assembly.	11. Replace heater blower assembly.
12. Noise with heater on.	12a. Dirty heater blower motor 12b. Defective heater/blower assembly.	12a. Gently vacuum heater blower vents. 12b. Replace heater/blower assembly.
13. Noise with flames on and heater off.	13a. Defective flame generator drive motor. 13b. Dented back panel 13c. Warped spinner shaft	13a. Replace flame generator drive motor. 13b. Refer to TSI customer service. 13c. Refer to TSI customer service.
14. Is it safe to place unit on carpet?	14. Product Inquiry	14. It is safe to place unit on carpet but make sure any flammable items are at least 3 feet away from front and sides of the unit.
15. How many square feet will my unit warm up?	15. Product Inquiry	15. Provides supplemental heat up to 1000 square feet
16. Flame effect works but heater function does not and the ember bed flashes when the heater button is pressed.	16. The heater is disabled.	16. With the power on press and hold the POWER button on the control panel for 10 seconds. Once re-enabled the emberbed lights will flash multiple times.
17. Remote control is not working when buttons are pressed.	17a. No batteries or battery power. 17b. Poor signal 17c. Distance	17a. Change the remote batteries. 17b. Operate remote transmitter at a slow measured pace. Press the remote control buttons with an even motion and gentle pressure. Repeatedly pressing buttons in rapid succession may cause the transmitter to malfunction. 17c. Operate the remote at a distance less than 20 feet from the front of the appliance; point the remote at the control panel.

EXPLODED VIEW

Part	Part Name	Part Number
1	Door Pull	Y19-S278-RH
2	Control Panel Circuit Board	Y19-S278-P32
3	Stove legs	SL-7117-01/SL-7117-02/SL-7117-03
4	Main Circuit Board	Y19-S278-P15
5	Heater/Blower Assembly	Y19-S278-P01
6	Flame Generator Drive Motor	Y19-S278-P10
7	Thermostat Sensor	NTC-5010
8	Remote control	P179

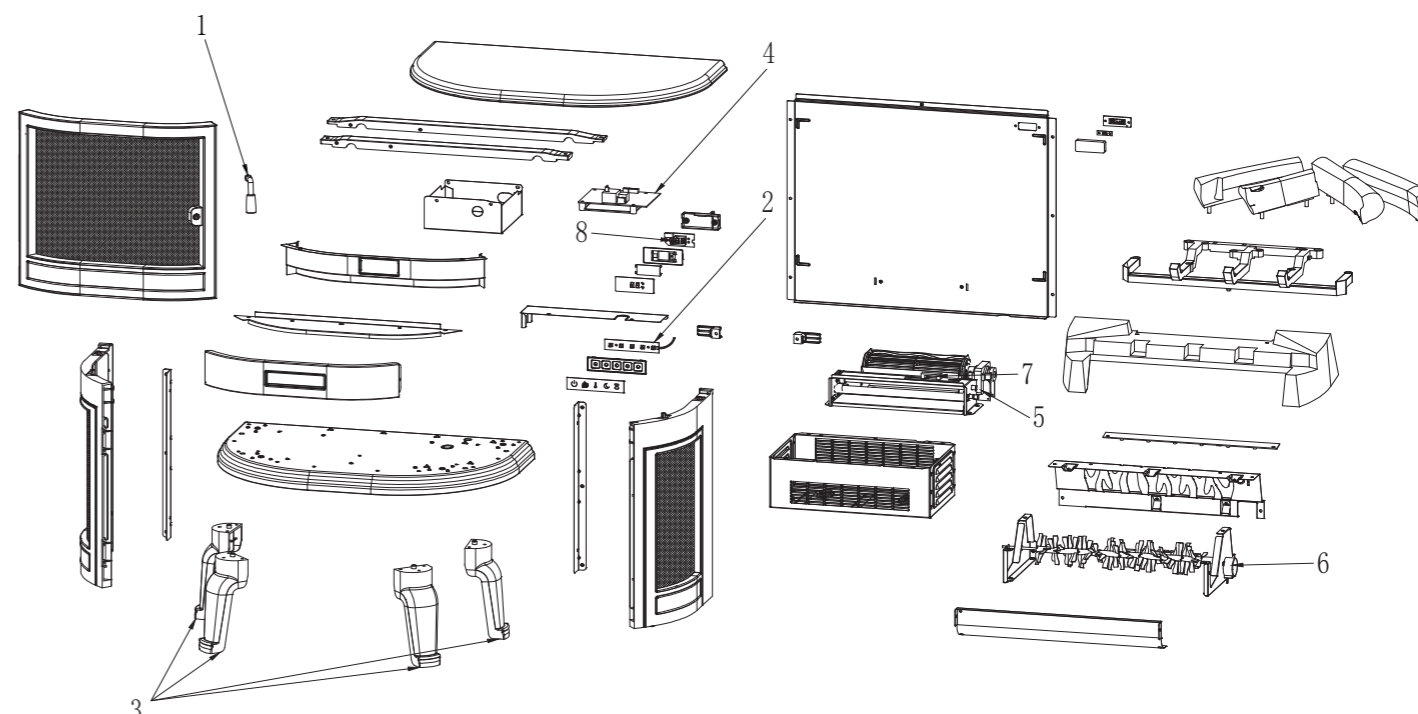

CARE AND MAINTENANCE

- Clean the trim using a soft cloth, slightly dampened with citrus oil based product and buff with a clean soft cloth.
- DO NOT use brass polish or household cleaners as these products will damage the metal trim. Citrus oil based products can be obtained at supermarkets or hardware stores.
- WARNING: Electrical outlet wiring must comply with local building codes and other applicable regulations to reduce the risk of fire, electrical shock and injury to persons.
- Warning: Disconnect power before attempting any maintenance or cleaning to reduce the risk of fire, electrical shock or personal injury.

FCC/IC INFORMATION

Warning: Changes or modifications to this unit not expressly approved by the party responsible for compliance could void user's authority to operate the equipment.
NOTE: This equipment has been tested and found to comply with the limits for Class B digital device, pursuant to part 15 of the FCC Rules. These limits are designed to provide reasonable protection against harmful interference in a residential installation. This equipment generates, uses, and can radiate radio frequency energy and, if not installed and used in accordance with the instructions, may cause harmful interference to radio communications.

However, there is no guarantee that interference will not occur in a particular installation. If this equipment does cause harmful interference to radio or television reception, which can be determined by turning the equipment off and on, the user is encouraged to try to correct the interference by one or more of the following measures.

- Reorient or relocate the receiving antenna.
- Increase the separation between the equipment and the receiver.
- Connect the equipment into an outlet on a circuit different from that to which the receiver is connected.
- Consult the dealer or an experienced radio/TV technician for help.

This device complies with Part 15 of the FCC Rules. Operation is subject to the following two conditions:

- (1) This device may not cause harmful interference, and
- (2) this device must accept any interference received, including interference that may cause undesired operation.

This Class B digital apparatus complies with Canadian ICES-003.