

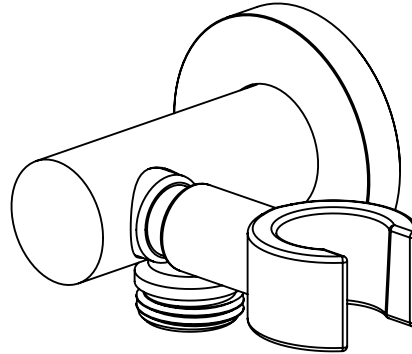

### SH-25S-65

#### Features

- Available in 28 finishes including 13 PVD finishes
- All brass construction
- 1/2" NPT (female) inlet connection
- 1/2" NPSM (male) outlet connection
- Positive-Lock swivel holder
- Accepts most conical handshower hoses



#### Codes/Standards

Product meets or exceeds the following:

- A112.18.1/CSA B125.1

