

Installation guide for
Guide d'installation pour

dals

1877 430 1818 ■ www.dals.com

Download the free Dals app
Téléchargez l'appli gratuite Dals



SM-UP1 (2.3W)
SM-UPK3 (11W)
SM-UPK5 (18W)

MODEL	LUMENS*	KELVIN	DIMMABLE**
SM-UPX	110 lm	RGB + 2700K - 6500K	✓

*Per puck
**Dimmable through app
* Par rondelle
** Intensité réglable via l'application

ITEMS INCLUDED IN THE BOX / ARTICLES INCLUS DANS LA BOÎTE

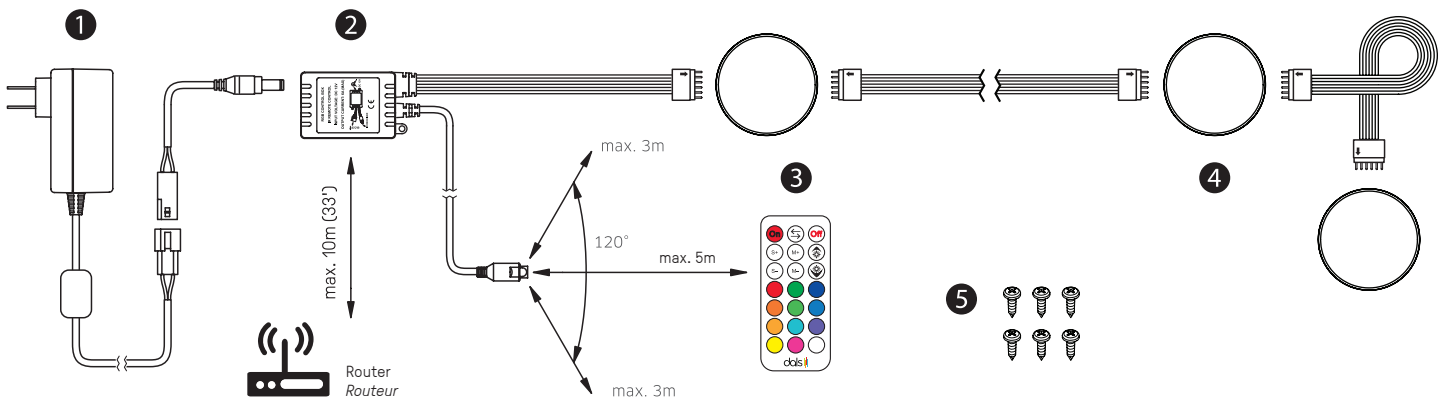

- 1** 1x plug-in LED driver
1x transformateur DEL enfichable
(Kits/Ensembles: SM-UPK3, SM-UPK5)
- 2** 1x WIFI controler with infrared receiver
1x contrôleur WIFI avec récepteur infrarouge
(Kits/Ensembles: SM-UPK3, SM-UPK5)
- 3** 1x wireless remote control
1x manette de contrôle sans-fils
(Kits/Ensembles: SM-UPK3, SM-UPK5)
- 4** RGB LED + Cool White & Warm White puck light
Rondelle DEL RGB + blanc froid et blanc chaud
(1x SM-UP1, 3x SM-UPK3, 5x SM-UPK5)
- 5** Mounting screws
Vis de montage
(2x SM-UP1, 6x SM-UPK3, 10x SM-UPK5)

LIGHT OUTPUT / SORTIE D'ÉCLAIRAGE



Approved for installation inside, under or over cabinets, with light shining in any directions.

Approuvé pour installation à l'intérieur, sous ou sur une armoire, éclairage dans n'importe quelle direction.

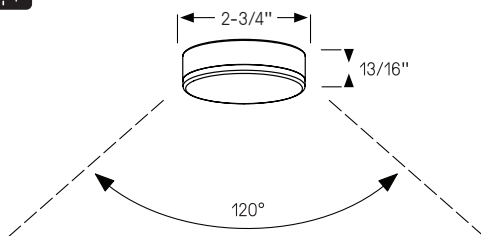

POLARITY / POLARITÉ

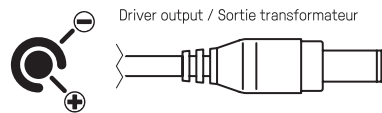

RGB control box input
Entrée module de contrôle RGB

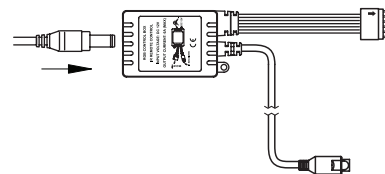

RGB control box output
Sortie module de contrôle RGB

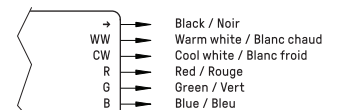

WARRANTY / GARANTIE

Dals offers a warranty of 5 years for the LED flexible tape light and driver from the date of purchase which covers repair or replacement of defective parts of the housing, optics, and electronics. To contact Dals customer service call to 1877 430 1818.

Dals offre une garantie de 5 ans pour le ruban flexible à DEL et pour le transformateur à partir de la date de l'achat qui couvre la réparation ou le remplacement des pièces du boîtier, des pièces optiques et électroniques défectueuses. Pour contacter le service à la clientèle de Dals, appelez au 1 877 430 1818.

Installation guide Guide d'installation

**SM-UP1
SM-UPK3
SM-UPK5**



BEFORE YOU START

Instructions pertaining to a risk of fire, electric shock or injury to persons. To reduce the risk of fire, electric shock or injury to persons; use only insulated staples or plastic ties to secure cords, route and secure cords so that they will not be pinched or damaged when the cabinet is pushed to the wall, position the portable cabinet light with respect to the cabinet so the lamp replacement markings are able to read during relamping. Not intended for recessed installation or for installation in ceilings, soffits, "built-in furnishings" such as a kitchen, china cabinet or trophy case. The low voltage portable cabinet light may be installed inside or under a kitchen cabinet or other built-in furniture when the low voltage Class 2 power supply is located outside the cabinet and is not concealed and when the line voltage power supply cord is not concealed or run through openings in the cabinet, walls, ceilings or floors. This requirement does not apply to the wiring between the cabinet light and the power unit. The National Electrical Code (NEC) does not permit cords to be concealed where damage to insulation may go unnoticed. To prevent fire danger, do not run cord behind walls, ceilings, soffits or cabinets where it may be inaccessible for examination, cords should be examined periodically and immediately replaced when any damage is noted.



AVANT DE COMMENCER

Ces instructions se rapportent à un risque d'incendie, de chocs électriques ou de blessures corporelles. Pour réduire le risque de feu, chocs ou blessures; utiliser des agrafes isolées ou attaches en plastique pour fixer les cordons, aussi les sécuriser pour prévenir les dommages quand un meuble est poussé au mur, positionner l'appareil pour que les marquages de lampes soient visibles lors du remplacement. Non prévus pour une installation encastrée ni pour être installé dans des plafonds, corniches extérieures ou "constructions structurales" tels que meubles-cuisine, vaisseliers ou armoires à trophées intégrés. L'appareil bas voltage peut être installé dans ou sous une armoire ou autres meubles encastrés quand le transformateur Classe 2 bas voltage est placé à l'extérieur de l'armoire et n'est pas caché et quand le cordon d'alimentation de tension de secteur n'est pas caché ou passé dans des ouvertures dans l'armoire, des murs, des plafonds ou des planchers. Cette condition ne s'applique pas au filage entre l'appareil et le transformateur. Le Code National de L'Électricité (CNE) ne permet pas que les cordons soient cachés où un dommage à l'isolation devient indétectable. Pour prévenir le risque de feu, ne pas passer les cordons derrière les murs, plafonds, corniches et meubles où l'examen est impossible, les cordons doivent être inspectés périodiquement et remplacés dès qu'un dommage est détecté.

INSTALLATION INSTRUCTIONS / INSTRUCTIONS D'INSTALLATION

1

Separate the fixture from its mounting plate.
Fasten the mounting plate to the desired surface
with the supplied screws.

Séparez le luminaire de sa plaque de montage.
Fixez la plaque de montage à la surface souhaitée
avec les vis fournies.

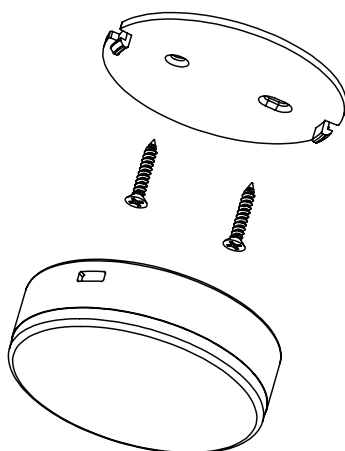

2

Connect the LED puck with the
RGB CCT control box by aligning
the connector arrows « → », then
connect the control box with the
LED driver and plug in to the wall
outlet.

Connectez la rondelle au module
de contrôle RGB CCT en alignant les
flèches de connexion « → », puis
connectez le module de contrôle RGB
CCT avec le Transformateur DEL et
branchez-le sur la prise murale.

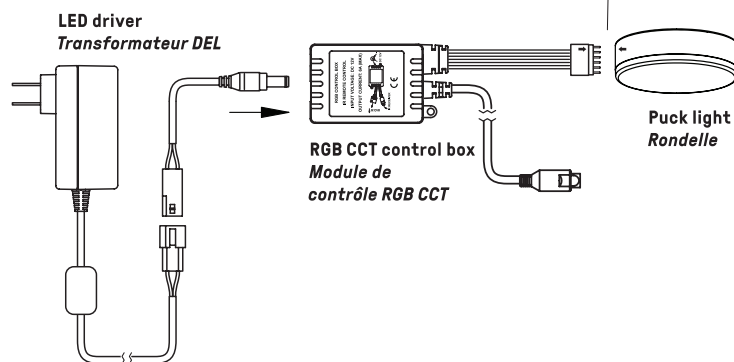

DALS REMOTE CONTROL / TÉLÉCOMMANDE DALS

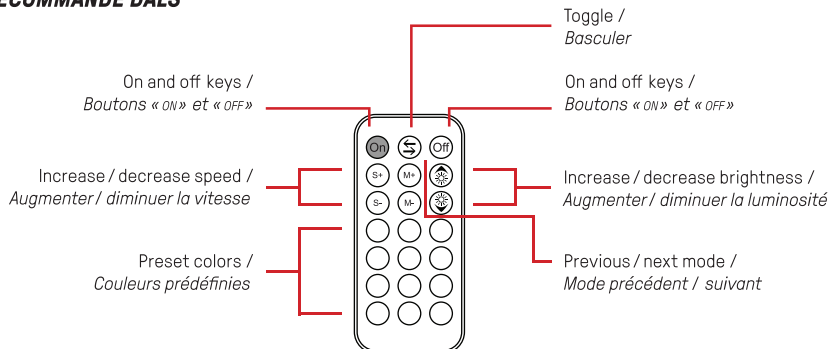

HARD RESET / RÉINITIALISATION AUX PARAMÈTRES D'USINE

If the controller cannot be seen by your phone and has not created its own WiFi access point, you may need to reset it.

Si le contrôleur ne peut être reconnu par votre appareil mobile et n'a pas créé son propre réseau Wi-Fi, vous pourriez avoir besoin de le réinitialiser aux paramètres d'usine.

1

Once light is on for 10+ seconds, unplug and plug in the driver 3 times quickly.
Une fois que l'appareil est allumé pendant plus de 10 secondes, débranchez et branchez
le transformateur 3 fois rapidement.

2

Go through the setup procedure again.
Refaire la procédure de connexion au réseau sans-fil.



A DOWNLOAD AND SET UP THE DALS APP

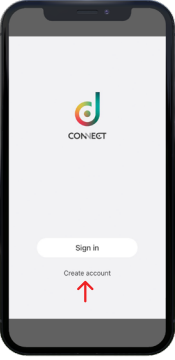

- 

Download the application "Dals Connect" on Google Play.
- 

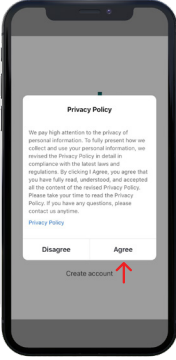
Open the application and click on "Create account" or click on "Sign in" if you already have an account.
- 

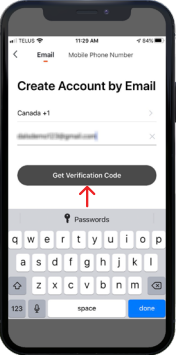
Please read the Privacy Policy and Terms of Use. Click on "Agree" if you acknowledge that you have understood and accepted the contents of this policy.
- 

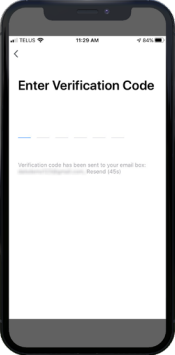
Define your country and enter your email address. Click on "Get Verification Code".
- 

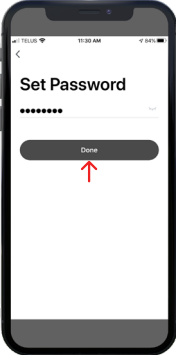
You will receive a verification code at the email address entered in Step 4. Enter the code in the space provided.
- 

Once the account has been created, enter your password. Click on "Done".

B CONNECT AND ADD SMART LIGHTING PRODUCTS

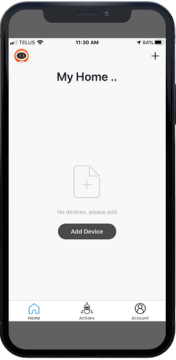
- 

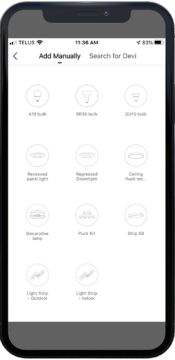
Open the Dals Connect app. To add a product, click on "Add Device" or the + icon at the top right corner.
- 

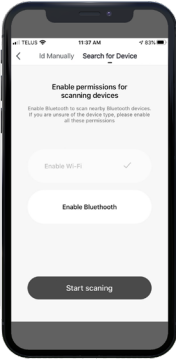
Choose the product you want to add among the proposed choices.
- 

In the "Search for Device" tab, make sure to "Enable Wi-Fi" if it is not already enabled. If you purchased a Bluetooth device, "Enable Bluetooth".

If you are unsure of the device type, please enable all these permissions
- 

To add your product, follow the 3 steps:
1- Power on
2- Turn On-off-on-off-on (Subject to User Manually)
3- Ensure light is fast blinking

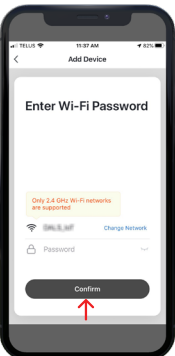
Click on "Confirm indicator rapidly blink".
- 

Connect your device on your Wi-Fi network. Enter your Wi-Fi and password in the space provided.

Only 2.4 GHz Wi-Fi networks are supported.

ANDROID INSTRUCTIONS



Download our free app
Télécharger notre application gratuite



B CONNECT AND ADD SMART LIGHTING PRODUCTS

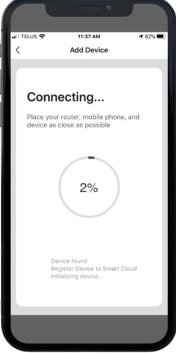

- 

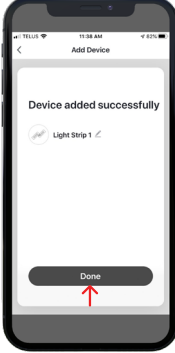
Your device is now connecting to your Wi-Fi network. Place your router, mobile phone, and device as close as possible. If the connection failed, please ensure the last steps were done correctly. Repeat if needed.
- 

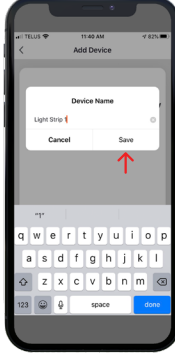
Your device has been added successfully. Click on "Done"
- 

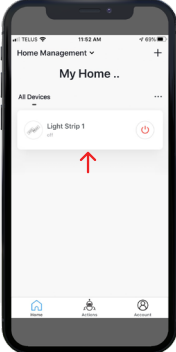
You can name your devices here. It will help you to organize your devices tree in the menu.
- 

Your device will appear on your home screen. You can directly manage all of your lighting products here.

C LIGHT UP YOUR WORLD WITH DALs

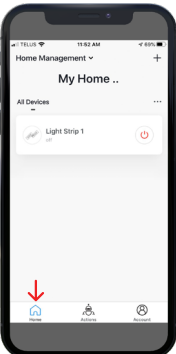
- 

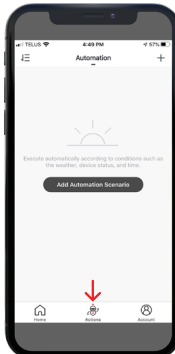
You can directly manage all of your lighting products on the menu by toggling On/Off or by clicking on a device for full customization.
- 

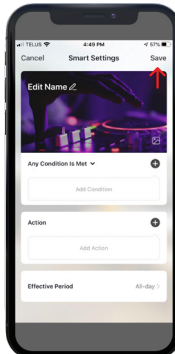
ACTIONS
"Scenario" let you control multiple devices with one tap or by using an AI speaker through voice commands.
"Automation" execute automatically according to conditions such as the weather, device status, and time.
- 

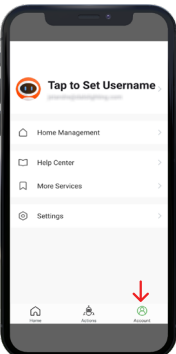
AUTOMATION
Once you clicked on "Add Automation Scenario", select a condition by clicking on the "+" icon. Same thing for the action. Then enter the period in which the automation will occur. Edit the name, the picture and click on "Save".
- 

ACCOUNT
Set your profil, secure your account, connect to AI speaker such as Google assistant or Amazon Alexa and much more.
Need help? Click on "Help Center" button



C LIGHT UP YOUR WORLD WITH DALs



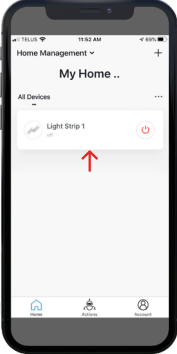

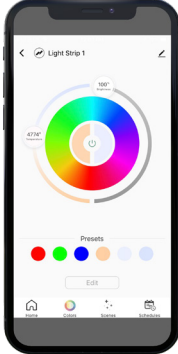
6.  You can directly manage all of your lighting products on the menu by toggling On/Off or by clicking on a device for full customization.

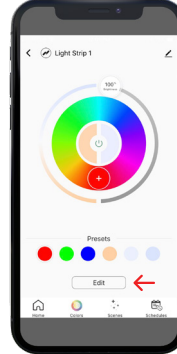
7.  Once you clicked on a device, you can set its colors, create multiple scenes and configure schedules.

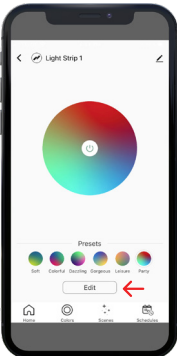
8.  **COLORS**
In the "Presets" section, you can edit a preselected color, enter a new color and then save it.

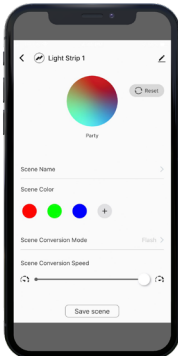
9.  **SCENES**
In the "Presets" section, you can select or create your own home atmosphere. To personalize your scene, click on "Edit".

10.  **SCENES**
Once you clicked on "Edit", you can change the scene name, create your own color composition, select your conversion mode (Static/Flash/Breath) and adjust the conversion speed.

11.  **SCHEDULES**
You can configure time actions by clicking on "Add timing" which let the app toggle lights On/Off at a specific time.

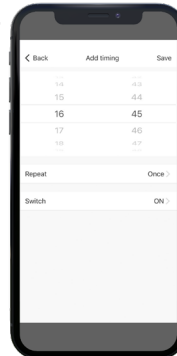
12.  **SCHEDULES**
Once you clicked on "Add timing", you can set the time and then select how often you want the device to switch On/Off.

Time	Repeat	Switch
14	Once	ON
15	Once	ON
16	45	ON
17	Once	ON
18	Once	ON

MAIN COLOR REMOTE CONTROL

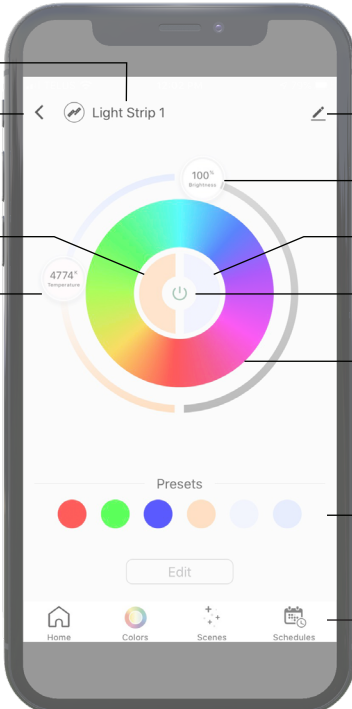

- Selected device
- Home
- Options
- Dimmer
- Hot (3000 K)
- Cold (5000 K)
- Color temperature
- On/Off
- RGB Circle
- Presets
- Toolbar (Home/Colors/Scenes/Schedules)



D GOOGLE ASSISTANT

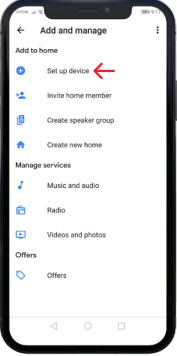

- 

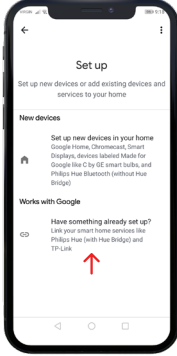
Open the Google Home app and click on “Add”, then click on “Set up device”.
- 

Click on “Have something already set up?” in “Works with Google”.
- 

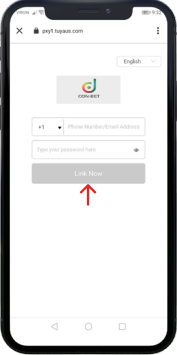
In the search box, enter “Magic Home WiFi” then select it.
- 

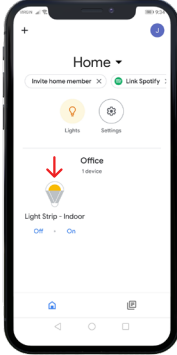
Login with your current account, the same account used during “A4” step.
- 

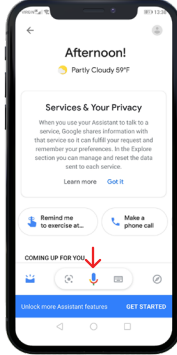
Your Dals smart devices will be listed in the “Home” section. Adding devices to a room enables commands like “turn on the living room lights”.
- 

Try saying, “Ok Google” then...

 - “Turn on light name/ room name”
 - “...Dim light name”
 - “Brighten light name”
 - “Set light name to 20%”
 - “Dim/Brighten light name to 50%”
 - “Turn light name/room name to red”
 - “Turn on/off everything”
 - “Is <light name> on?”

E AMAZON ALEXA

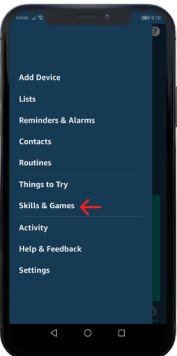
- 

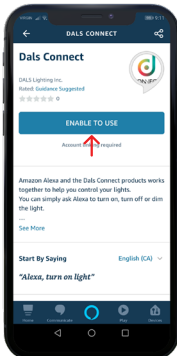
Open the Amazon Alexa app and click on ☰ at the top left corner, then click on “Skills & Games”.
- 

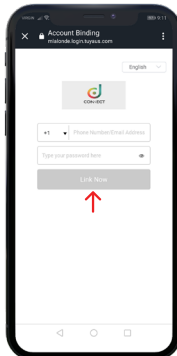
In the search box, enter “Dals Connect”.
You should see the skill appear in the search results. Tap on the “Dals Connect” skill to enable access.
- 

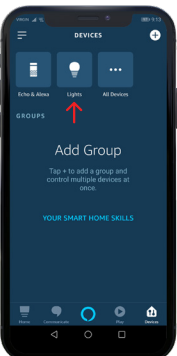
You will need to link your device. Login with your current account, the same account used during “A4” step.
- 

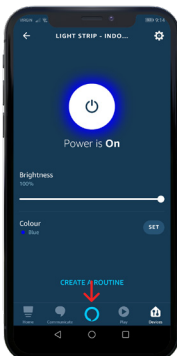
Your smart devices will be listed in the “Devices” tab at the bottom of the home screen. Adding devices to a room enables commands like “turn on the living room lights”.
- 

Try saying, “Alexa” then...

 - “Turn on light name/ room name”
 - “...Dim light name”
 - “Brighten light name”
 - “Set light name to 20%”
 - “Dim/Brighten light name to 50%”
 - “Turn light name/room name to red”
 - “Turn on/off everything”
 - “Is <light name> on?”



Download our free app
Télécharger notre application gratuite



A DOWNLOAD AND SET UP THE DALS APP



- 

Download the application "Dals Connect" in the App store.

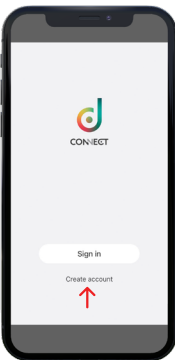
- 

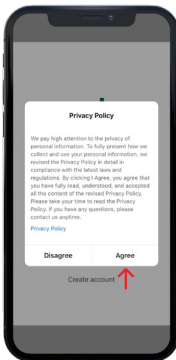
Open the application and click on "Create account" or click on "Sign in" if you already have an account.
- 

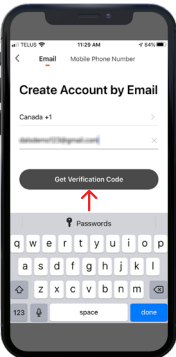
Please read the Privacy Policy and Terms of Use. Click on "Agree" if you acknowledge that you have understood and accepted the contents of this policy.
- 

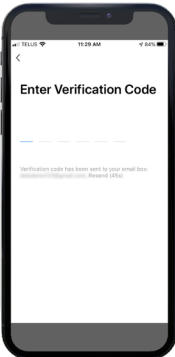
Define your country and enter your email address. Click on "Get Verification Code".
- 

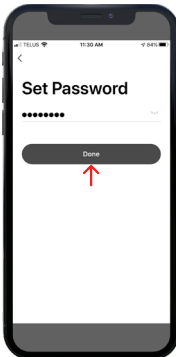
You will receive a verification code at the email address entered in Step 4. Enter the code in the space provided.
- 

Once the account has been created, enter your password. Click on "Done".

B CONNECT AND ADD SMART LIGHTING PRODUCTS

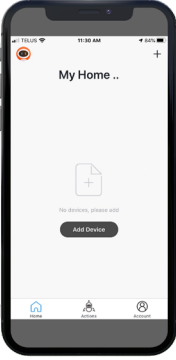
- 

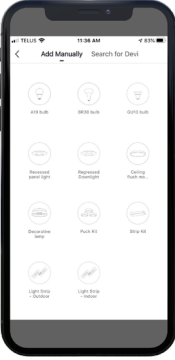
Open the Dals Connect app. To add a product, click on "Add Device" or the + icon at the top right corner.
- 

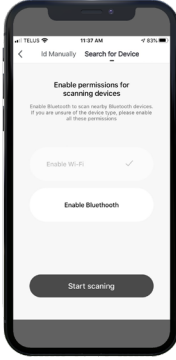
Choose the product you want to add among the proposed choices.
- 

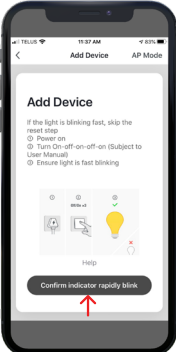
In the "Search for Device" tab, make sure to "Enable Wi-Fi" if it is not already enabled. If you purchased a Bluetooth device, "Enable Bluetooth". If you are unsure of the device type, please enable all these permissions
- 

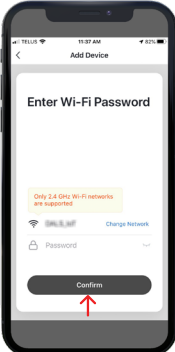
To add your product, follow the 3 steps:
1- Power on
2- Turn On-off-on-off-on (Subject to User Manually)
3- Ensure light is fast blinking
Click on "Confirm indicator rapidly blink".
- 

Connect your device on your Wi-Fi network. Enter your Wi-Fi and password in the space provided. Only 2.4 GHz Wi-Fi networks are supported.



Download our free app
Télécharger notre application gratuite



B CONNECT AND ADD SMART LIGHTING PRODUCTS

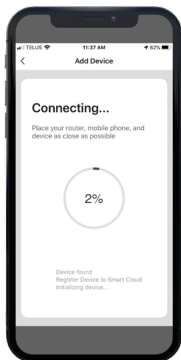
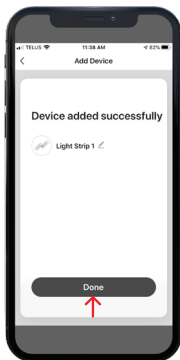
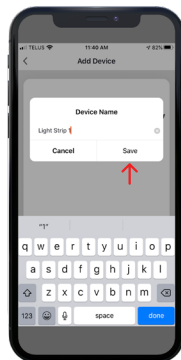
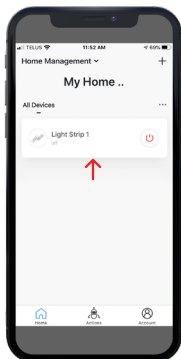

6.  Your device is now connecting to your Wi-Fi network. Place your router, mobile phone, and device as close as possible. If the connection failed, please ensure the last steps were done correctly. Repeat if needed.
7.  Your device has been added successfully. Click on “Done”
8.  You can name your devices here. It will help you to organize your devices tree in the menu.
9.  Your device will appear on your home screen. You can directly manage all of your lighting products here.

C LIGHT UP YOUR WORLD WITH DAL'S

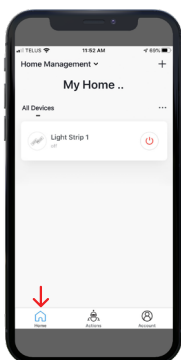
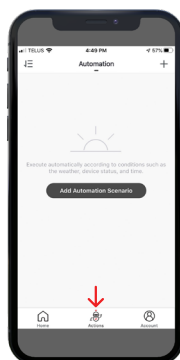
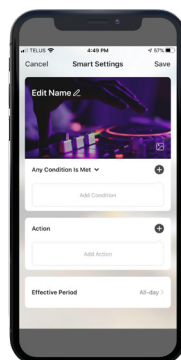
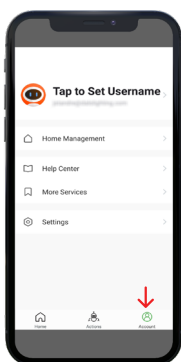
1.  You can directly manage all of your lighting products on the menu by toggling On/Off or by clicking on a device for full customization.
2.  **ACTIONS**
“Scenario” let you control multiple devices with one tap or by using an AI speaker through voice commands.
“Automation” execute automatically according to conditions such as the weather, device status, and time.
3.  **AUTOMATION**
Once you clicked on “Add Automation Scenario”, select a condition by clicking on the + icon. Same thing for the action. Then enter the period in which the automation will occur. Edit the name, the picture and click on “Save”.
4.  **ACCOUNT**
Set your profil, secure your account, connect to AI speaker such as Google assistant or Amazon Alexa and much more.
Need help? Click on “Help Center” button



C LIGHT UP YOUR WORLD WITH DALs



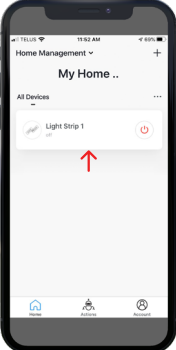

6.  You can directly manage all of your lighting products on the menu by toggling On/Off or by clicking on a device for full customization.

7.  Once you clicked on a device, you can set its colors, create multiple scenes and configure schedules.

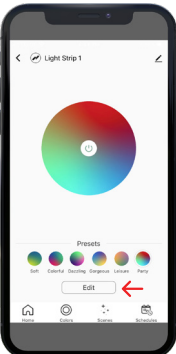
8.  COLORS
In the "Presets" section, you can edit a preselected color, enter a new color and then save it.

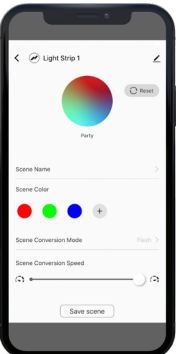
9.  SCENES
In the "Presets" section, you can select or create your own home atmosphere. To personalize your scene, click on "Edit".

10.  SCENES
Once you clicked on "Edit", you can change the scene name, create your own color composition, select your conversion mode (Static/Flash/Breath) and adjust the conversion speed.

11.  SCHEDULES
You can configure time actions by clicking on "Add timing" which let the app toggle lights On/Off at a specific time.

12.  SCHEDULES
Once you clicked on "Add timing", you can set the time and then select how often you want the device to switch On/Off.

Time	Repeat
14	0:0
15	0:4
16	4:5
17	0:0
18	0:0

Repeat: Once
Switch: ON

MAIN COLOR REMOTE CONTROL

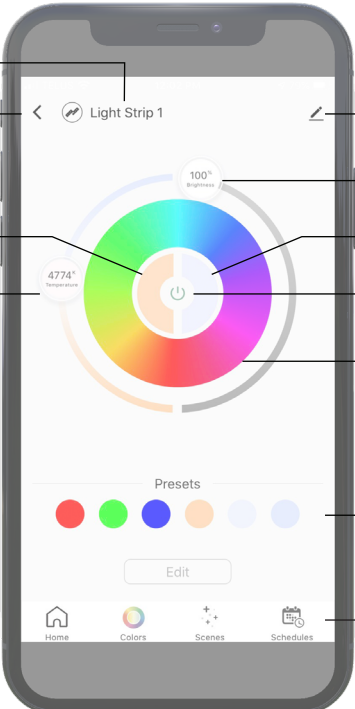

Selected device — Home — Light Strip 1 — Options

Hot (3000 K) — Dimmer (100% Brightness)

Color temperature — 4774° temperature — Cold (5000 K)

On/Off

RGB Circle

Presets

Toolbar (Home/Colors/Scenes/Schedules)



D GOOGLE ASSISTANT

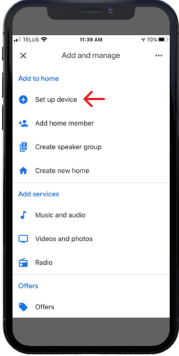

- 

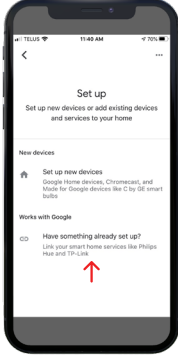
Open the Google Home app and click on “Add”, then click on “Set up device”.
- 

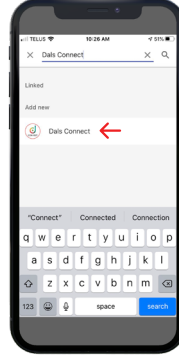
Click on “Have something already set up?” in “Works with Google”.
- 

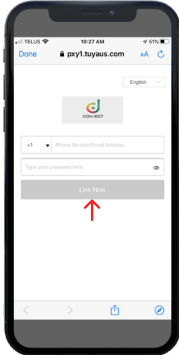
In the search box, enter “Dals Connect” then select it.
- 

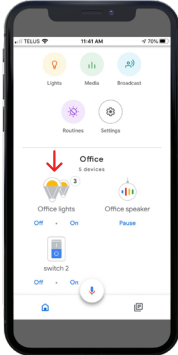
Login with your current account, the same account used during “A4” step.
- 

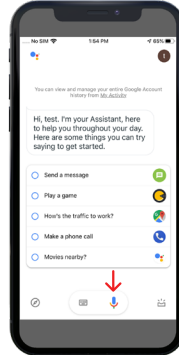
Your Dals smart devices will be listed in the “Home” section. Adding devices to a room enables commands like “turn on the living room lights”.
- 

Try saying, “Ok Google” then...

 - “Turn on light name/ room name”
 - “...Dim light name”
 - “Brighten light name”
 - “Set light name to 20%”
 - “Dim/Brighten light name to 50%”
 - “Turn light name/room name to red”
 - “Turn on/off everything”
 - “Is <light name> on?”

E AMAZON ALEXA

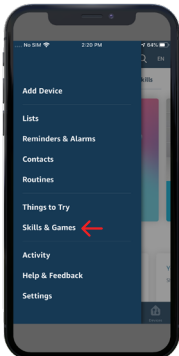
- 

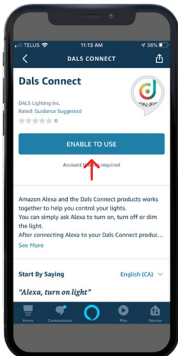
Open the Amazon Alexa app and click on ☰ at the top left corner, then click on “Skills & Games”.
- 

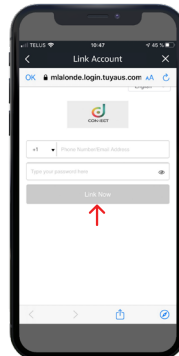
In the search box, enter “Dals Connect”.
You should see the skill appear in the search results. Tap on the “Dals Connect” skill to enable access.
- 

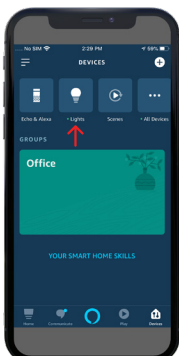
You will need to link your device. Login with your current account, the same account used during “A4” step.
- 

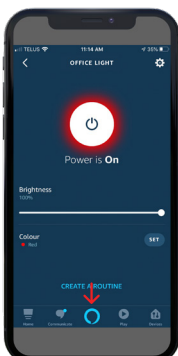
Your smart devices will be listed in the “Devices” tab at the bottom of the home screen. Adding devices to a room enables commands like “turn on the living room lights”.
- 

Try saying, “Alexa” then...

 - “Turn on light name/ room name”
 - “...Dim light name”
 - “Brighten light name”
 - “Set light name to 20%”
 - “Dim/Brighten light name to 50%”
 - “Turn light name/room name to red”
 - “Turn on/off everything”
 - “Is <light name> on?”