

Installation guide for
Guide d'installation pour

SM-PNL6WH

dals

1 877 430 1818 ■ www.dals.com

Download the free Dals Connect app
 Téléchargez l'appli gratuite Dals Connect



MODEL	LUMENS	WATTS	KELVIN	DIMMABLE*
SM-PNL6WH	1000 lm	15W	2700K - 6500K	✓

*Dimmable through app.

*Intensité réglable
 via l'application.

ITEMS INCLUDED IN THE BOX / ARTICLES INCLUS DANS LA BOÎTE

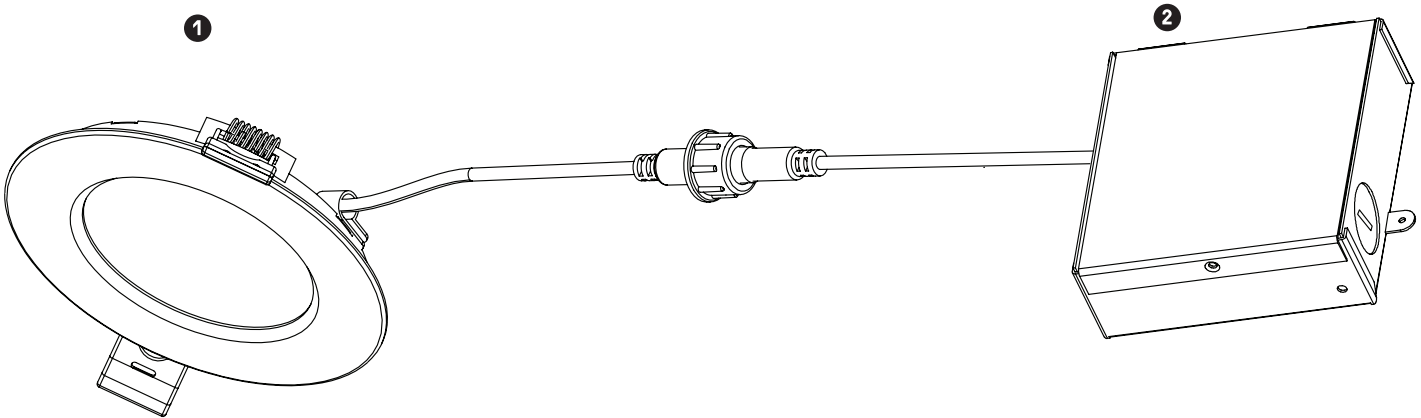

1 1x Smart LED panel light
 1x Panneau intelligent DEL

2 1x Junction box with integrated WiFi controller
 1x boîte de jonction avec contrôleur WiFi intégré

**SIDE VIEW OF INSTALLATION /
 VUE DE CÔTÉ DE L'INSTALLATION D'ÉCLAIRAGE**

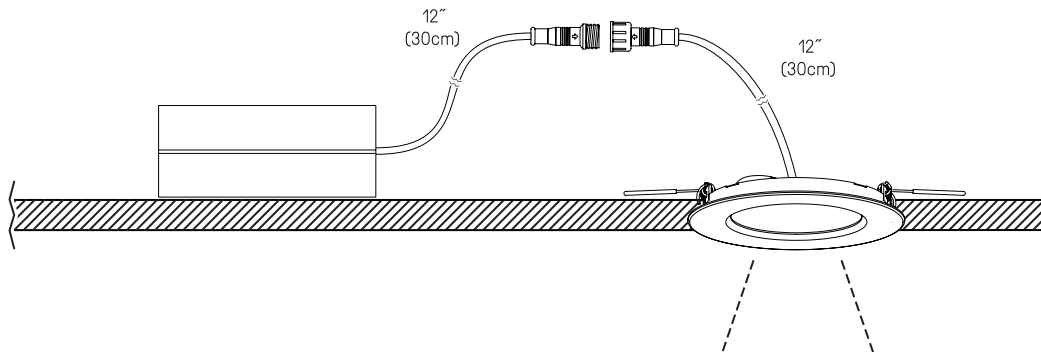

Beam angle: 120°
 Faisceau lumineux: 120°

WARRANTY / GARANTIE

Dals offers a warranty of 5 years for the LED panel light from the date of purchase that covers repair or replacement of defective parts of the housing, optics, and electronics. To contact Dals customer service call 1-877-430-1818 or send an e-mail to info@dals.com

Dals offre une garantie de 5 ans pour le panneau DEL à partir de la date de l'achat qui couvre la réparation ou le remplacement des pièces du boîtier, des pièces optiques et électroniques défectueuses. Pour contacter le service à la clientèle de Dals, appelez au 1-877-430-1818 ou envoyez un courriel à info@dals.com



BEFORE YOU START

BEFORE STARTING INSTALLATION, SHUT THE LINE FEED POWER OFF USING THE CIRCUIT BREAKER.

Recessed downlight installation requires knowledge of luminaires electrical systems. Installation should be done by a certified electrician. To prevent wiring damage or abrasion, do not expose wiring to edges of sheet metal or other sharp objects. Suitable for dry Locations, IC certified, FCC certified, air-tight, ETL certified listed compliant.



AVANT DE COMMENCER

AVANT DE DÉBUTER L'INSTALLATION, COUPER L'ALIMENTATION DU FIL DU SECTEUR À L'AIDE DU DISJONCTEUR.

L'installation du plafonnier encastré doit être effectuée conformément aux codes électriques locaux. L'installation doit être faite par un électricien certifié. Pour éviter d'endommager le câblage, ne pas exposer à tout objet tranchant. Convient aux endroits sec, certifié IC, FCC, étanche à l'air, et ETL.

INSTALLATION INSTRUCTIONS / INSTRUCTIONS D'INSTALLATION

1

Drill hole in ceiling and prepare supply wires. Install and unshield the line feed wire 6" (15 cm) and strip wires 5/8" (1.6 cm). Bring supply power to junction box through knockout.

Percer le trou dans le plafond et préparez les fils d'alimentation. Installer et dénuder le fil du secteur de 6 po. (15 cm) et dénuder les fils de 5/8 po. (1,6 cm). Apporter l'alimentation électrique jusque dans la boîte de connexion.



SM-PNL6WH
Ø 6-1/4"

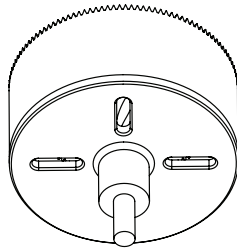
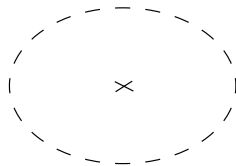

2

Open the lid of the junction box. Use the connectors and match the white wire from the line feed with the white wire of the junction box, match the black wire from the line feed with the black wire of the junction box, and match the copper wire from the line feed with the green wire of the junction box.

Ouvrir le couvercle sur la boîte de connexion. Utiliser les connecteurs pour jumeler le fil blanc du secteur avec le fil blanc de la boîte de jonction, pour jumeler le fil noir du secteur avec le fil noir de la boîte de jonction et pour jumeler le fil de cuivre du secteur avec le fil vert de la boîte de jonction.

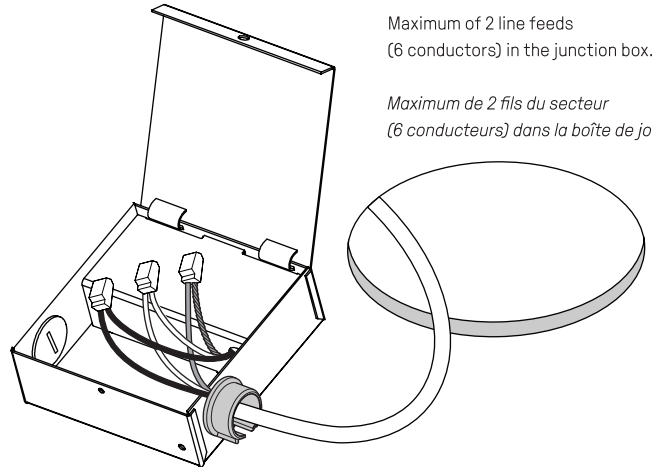

Maximum of 2 line feeds
(6 conductors) in the junction box.

*Maximum de 2 fils du secteur
(6 conducteurs) dans la boîte de jonction.*

3

Push junction box through cut-out and connect recessed LED panel to junction box with the quick connector.

Rentrer le boîtier dans le plafond et connecter le panneau encastré DEL à la boîte de jonction à l'aide du connecteur.

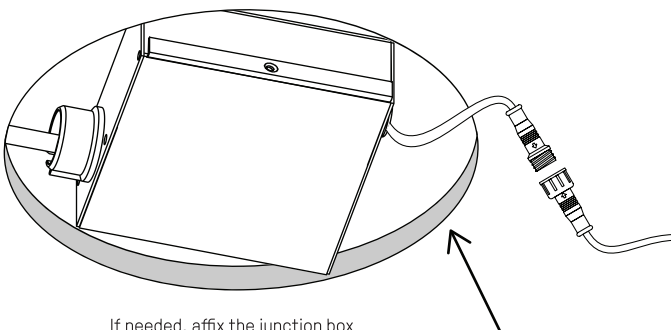

If needed, affix the junction box through keyholes to keep in place

Si nécessaire, fixer la boîte de jonction à l'aide des trous prévus à cet effet

4

Compress the springs and push the fixture in the opening. It is easier to do one spring at a time.

Comprimer les ressorts et pousser l'appareil dans le trou. Il est préférable d'y aller un ressort à la fois.

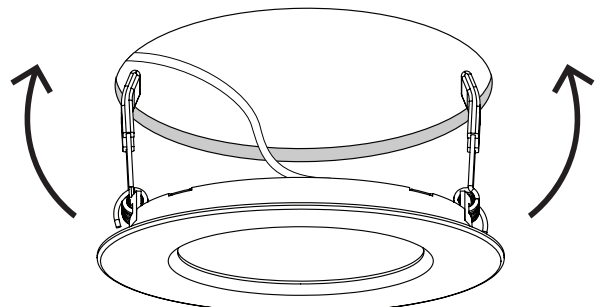



Download our free app
Télécharger notre application gratuite



A DOWNLOAD AND SET UP THE DALS APP

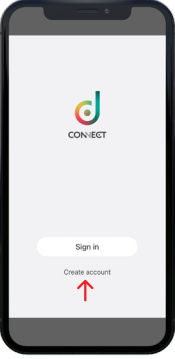

- 

Download the application "Dals Connect" on Google Play.
- 

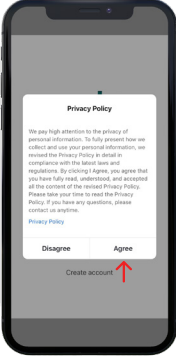
Open the application and click on "Create account" or click on "Sign in" if you already have an account.
- 

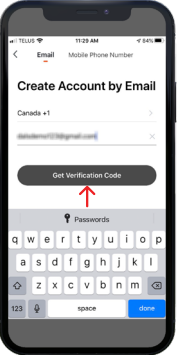
Please read the Privacy Policy and Terms of Use. Click on "Agree" if you acknowledge that you have understood and accepted the contents of this policy.
- 

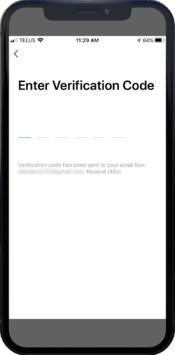
Define your country and enter your email address. Click on "Get Verification Code".
- 

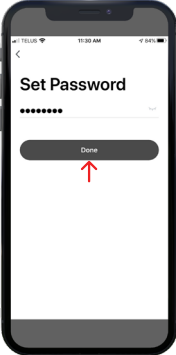
You will receive a verification code at the email address entered in Step 4. Enter the code in the space provided.
- 

Once the account has been created, enter your password. Click on "Done".

B CONNECT AND ADD SMART LIGHTING PRODUCTS

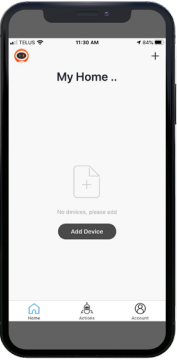
- 

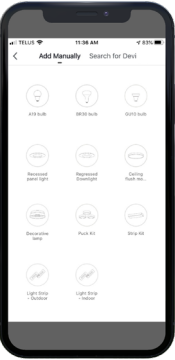
Open the Dals Connect app. To add a product, click on "Add Device" or the + icon at the top right corner.
- 

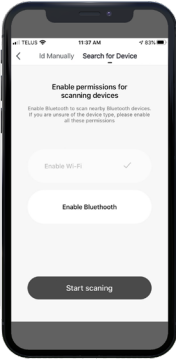
Choose the product you want to add among the proposed choices.
- 

In the "Search for Device" tab, make sure to "Enable Wi-Fi" if it is not already enabled. If you purchased a Bluetooth device, "Enable Bluetooth".

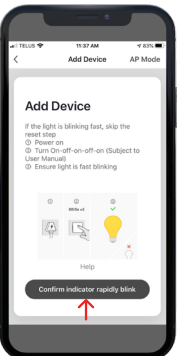
If you are unsure of the device type, please enable all these permissions
- 

To add your product, follow the 3 steps:
1- Power on
2- Turn On-off-on-off-on (Subject to User Manually)
3- Ensure light is fast blinking

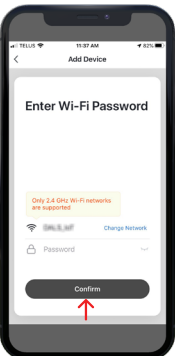
Click on "Confirm indicator rapidly blink".
- 

Connect your device on your Wi-Fi network. Enter your Wi-Fi and password in the space provided.

Only 2.4 GHz Wi-Fi networks are supported.

ANDROID INSTRUCTIONS



Download our free app
Télécharger notre application gratuite



B CONNECT AND ADD SMART LIGHTING PRODUCTS

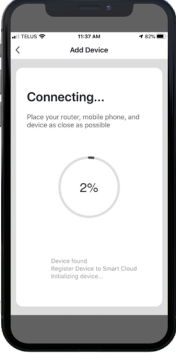

- 

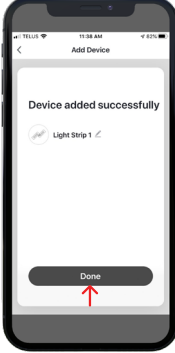
Your device is now connecting to your Wi-Fi network. Place your router, mobile phone, and device as close as possible. If the connection failed, please ensure the last steps were done correctly. Repeat if needed.
- 

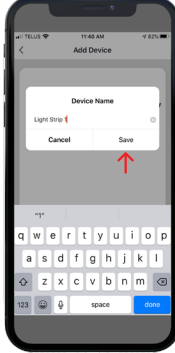
Your device has been added successfully. Click on "Done"
- 

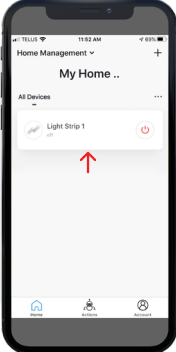
You can name your devices here. It will help you to organize your devices tree in the menu.
- 

Your device will appear on your home screen. You can directly manage all of your lighting products here.

C LIGHT UP YOUR WORLD WITH DAL'S

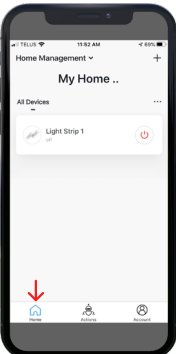
- 

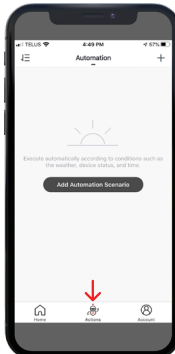
You can directly manage all of your lighting products on the menu by toggling On/Off or by clicking on a device for full customization.
- 

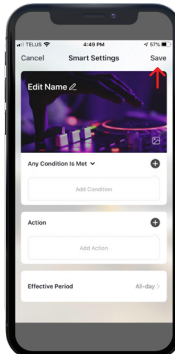
ACTIONS
"Scenario" let you control multiple devices with one tap or by using an AI speaker through voice commands.
"Automation" execute automatically according to conditions such as the weather, device status, and time.
- 

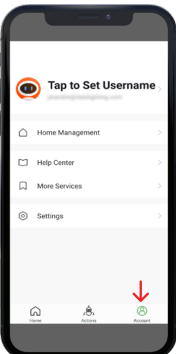
AUTOMATION
Once you clicked on "Add Automation Scenario", select a condition by clicking on the "+" icon. Same thing for the action. Then enter the period in which the automation will occur. Edit the name, the picture and click on "Save".
- 

ACCOUNT
Set your profil, secure your account, connect to AI speaker such as Google assistant or Amazon Alexa and much more.
Need help? Click on "Help Center" button



C LIGHT UP YOUR WORLD WITH DAL'S



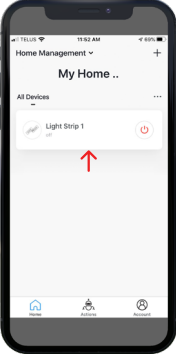

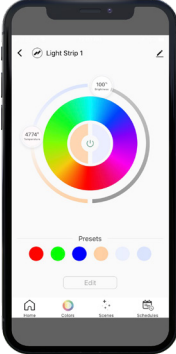
6.  You can directly manage all of your lighting products on the menu by toggling On/Off or by clicking on a device for full customization.

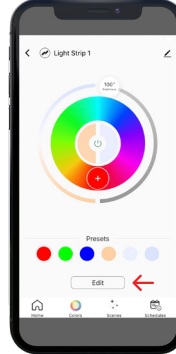
7.  Once you clicked on a device, you can set its colors, create multiple scenes and configure schedules.

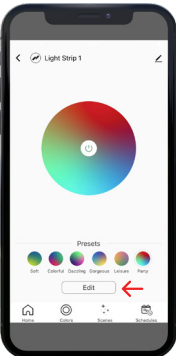
8.  **COLORS**
In the "Presets" section, you can edit a preselected color, enter a new color and then save it.

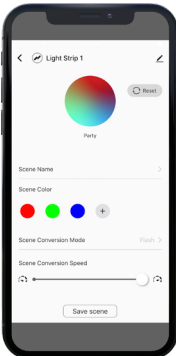
9.  **SCENES**
In the "Presets" section, you can select or create your own home atmosphere. To personalize your scene, click on "Edit".

10.  **SCENES**
Once you clicked on "Edit", you can change the scene name, create your own color composition, select your conversion mode (Static/Flash/Breath) and adjust the conversion speed.

11.  **SCHEDULES**
You can configure time actions by clicking on "Add timing" which let the app toggle lights On/Off at a specific time.

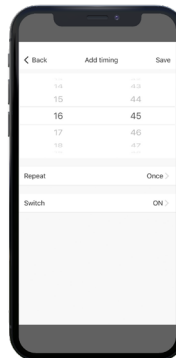
12.  **SCHEDULES**
Once you clicked on "Add timing", you can set the time and then select how often you want the device to switch On/Off.

Time	Frequency
14	:00
15	:45
16	45
17	:00
18	:00
Repeat	Once
Switch	ON

MAIN COLOR REMOTE CONTROL

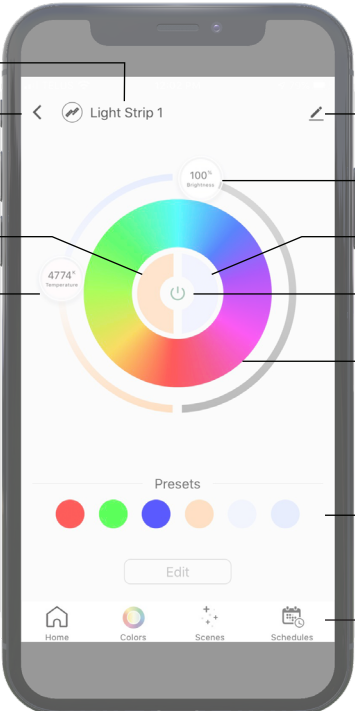

- Selected device
- Home
- Options
- Dimmer
- Hot (3000 K)
- Cold (5000 K)
- Color temperature
- On/Off
- RGB Circle
- Presets
- Toolbar (Home/Colors/Scenes/Schedules)



D GOOGLE ASSISTANT

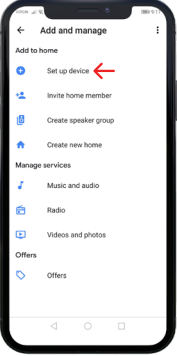

- 

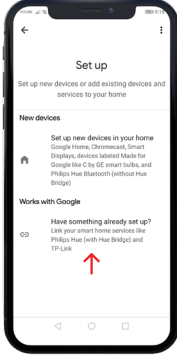
Open the Google Home app and click on “Add”, then click on “Set up device”.
- 

Click on “Have something already set up?” in “Works with Google”.
- 

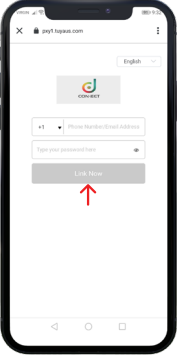
In the search box, enter “Magic Home WiFi” then select it.
- 

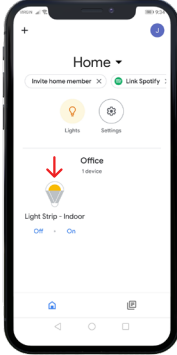
Login with your current account, the same account used during “A4” step.
- 

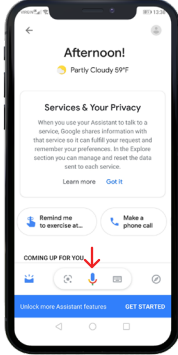
Your Dals smart devices will be listed in the “Home” section. Adding devices to a room enables commands like “turn on the living room lights”.
- 

Try saying, “Ok Google” then...

 - “Turn on light name/ room name”
 - “...Dim light name”
 - “Brighten light name”
 - “Set light name to 20%”
 - “Dim/Brighten light name to 50%”
 - “Turn light name/room name to red”
 - “Turn on/off everything”
 - “Is <light name> on?”

E AMAZON ALEXA

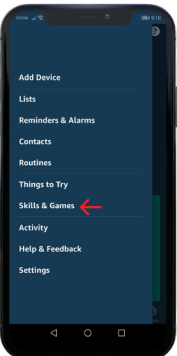
- 

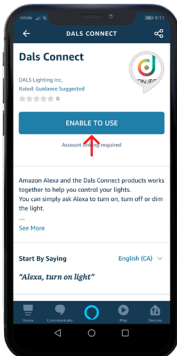
Open the Amazon Alexa app and click on ☰ at the top left corner, then click on “Skills & Games”.
- 

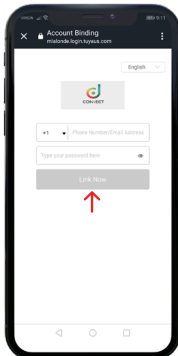
In the search box, enter “Dals Connect”.
You should see the skill appear in the search results. Tap on the “Dals Connect” skill to enable access.
- 

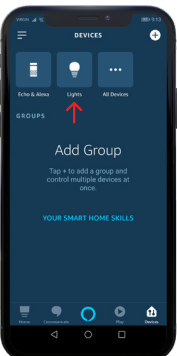
You will need to link your device. Login with your current account, the same account used during “A4” step.
- 

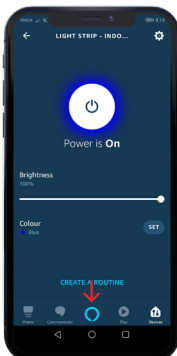
Your smart devices will be listed in the “Devices” tab at the bottom of the home screen. Adding devices to a room enables commands like “turn on the living room lights”.
- 

Try saying, “Alexa” then...

 - “Turn on light name/ room name”
 - “...Dim light name”
 - “Brighten light name”
 - “Set light name to 20%”
 - “Dim/Brighten light name to 50%”
 - “Turn light name/room name to red”
 - “Turn on/off everything”
 - “Is <light name> on?”



Download our free app
Télécharger notre application gratuite



A DOWNLOAD AND SET UP THE DALS APP



- 

Download the application "Dals Connect" in the App store.

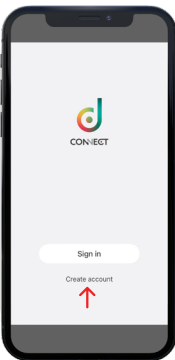
- 

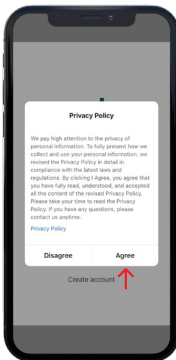
Open the application and click on "Create account" or click on "Sign in" if you already have an account.
- 

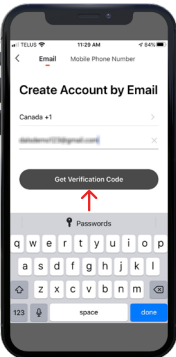
Please read the Privacy Policy and Terms of Use. Click on "Agree" if you acknowledge that you have understood and accepted the contents of this policy.
- 

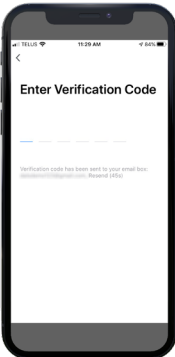
Define your country and enter your email address. Click on "Get Verification Code".
- 

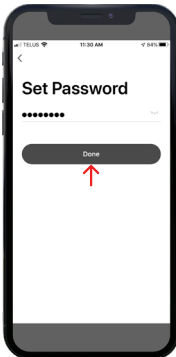
You will receive a verification code at the email address entered in Step 4. Enter the code in the space provided.
- 

Once the account has been created, enter your password. Click on "Done".

B CONNECT AND ADD SMART LIGHTING PRODUCTS

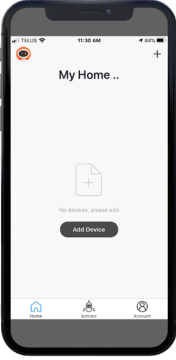
- 

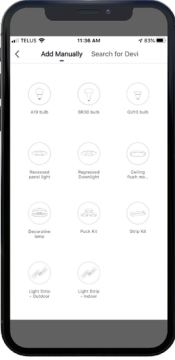
Open the Dals Connect app. To add a product, click on "Add Device" or the + icon at the top right corner.
- 

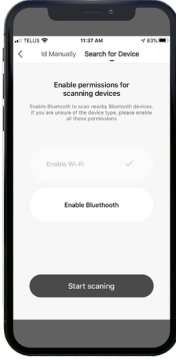
Choose the product you want to add among the proposed choices.
- 

In the "Search for Device" tab, make sure to "Enable Wi-Fi" if it is not already enabled. If you purchased a Bluetooth device, "Enable Bluetooth".

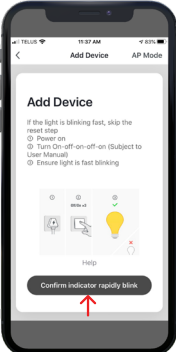
If you are unsure of the device type, please enable all these permissions
- 

To add your product, follow the 3 steps:
1- Power on
2- Turn On-off-on-off-on (Subject to User Manually)
3- Ensure light is fast blinking

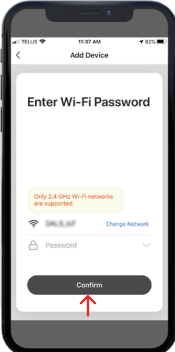
Click on "Confirm indicator rapidly blink".
- 

Connect your device on your Wi-Fi network. Enter your Wi-Fi and password in the space provided.

Only 2.4 GHz Wi-Fi networks are supported.



Download our free app
Télécharger notre application gratuite



B CONNECT AND ADD SMART LIGHTING PRODUCTS

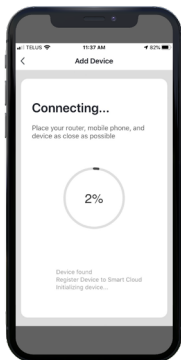
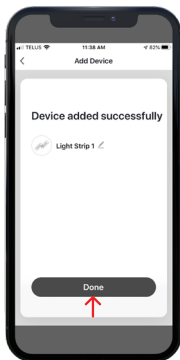
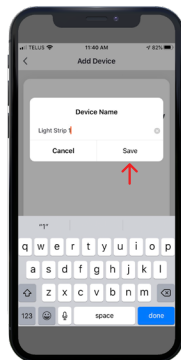
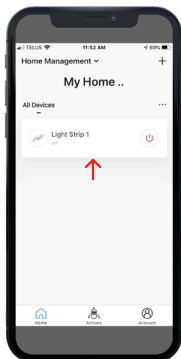

6.  Your device is now connecting to your Wi-Fi network. Place your router, mobile phone, and device as close as possible. If the connection failed, please ensure the last steps were done correctly. Repeat if needed.
7.  Your device has been added successfully. Click on “Done”
8.  You can name your devices here. It will help you to organize your devices tree in the menu.
9.  Your device will appear on your home screen. You can directly manage all of your lighting products here.

C LIGHT UP YOUR WORLD WITH DAL'S

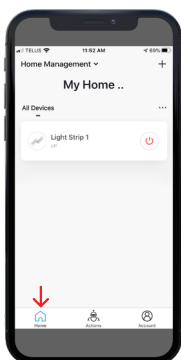
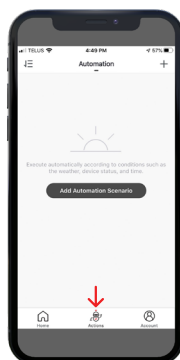
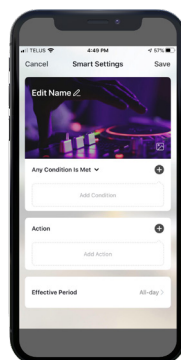
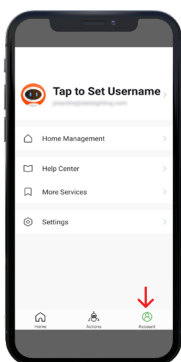
1.  You can directly manage all of your lighting products on the menu by toggling On/Off or by clicking on a device for full customization.
2.  **ACTIONS**
“Scenario” let you control multiple devices with one tap or by using an AI speaker through voice commands.
“Automation” execute automatically according to conditions such as the weather, device status, and time.
3.  **AUTOMATION**
Once you clicked on “Add Automation Scenario”, select a condition by clicking on the + icon. Same thing for the action. Then enter the period in which the automation will occur. Edit the name, the picture and click on “Save”.
4.  **ACCOUNT**
Set your profil, secure your account, connect to AI speaker such as Google assistant or Amazon Alexa and much more.
Need help? Click on “Help Center” button



C LIGHT UP YOUR WORLD WITH DALs



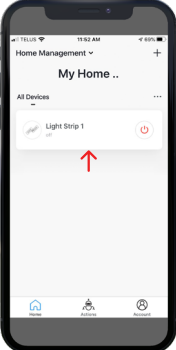

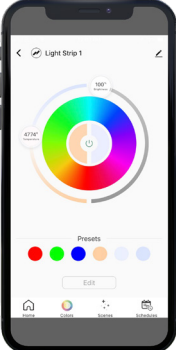
6.  You can directly manage all of your lighting products on the menu by toggling On/Off or by clicking on a device for full customization.

7.  Once you clicked on a device, you can set its colors, create multiple scenes and configure schedules.

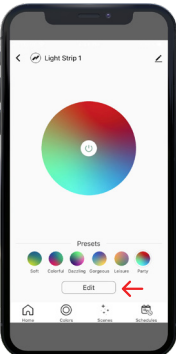
8.  COLORS
In the "Presets" section, you can edit a preselected color, enter a new color and then save it.

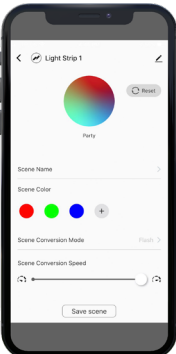
9.  SCENES
In the "Presets" section, you can select or create your own home atmosphere. To personalize your scene, click on "Edit".

10.  SCENES
Once you clicked on "Edit", you can change the scene name, create your own color composition, select your conversion mode (Static/Flash/Breath) and adjust the conversion speed.

11.  SCHEDULES
You can configure time actions by clicking on "Add timing" which let the app toggle lights On/Off at a specific time.

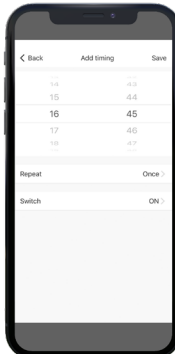
12.  SCHEDULES
Once you clicked on "Add timing", you can set the time and then select how often you want the device to switch On/Off.

Time	Frequency
14	0.0
15	0.4
16	4.5
17	0.0
18	0.0

Repeat: Once
Switch: ON

MAIN COLOR REMOTE CONTROL

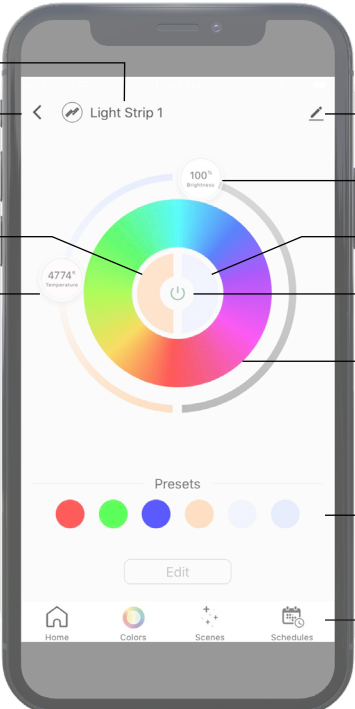

Selected device
Home
Options
Dimmer
Hot (3000 K)
Cold (5000 K)
Color temperature
On/Off
RGB Circle
Presets
Toolbar (Home/Colors/Scenes/Schedules)



D GOOGLE ASSISTANT

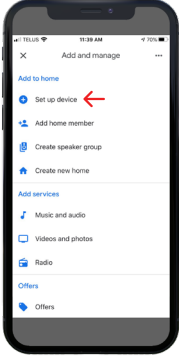

- 

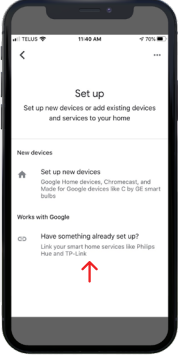
Open the Google Home app and click on “Add”, then click on “Set up device”.
- 

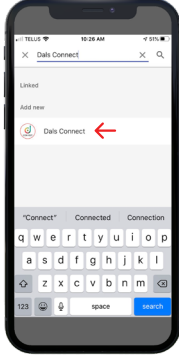
Click on “Have something already set up?” in “Works with Google”.
- 

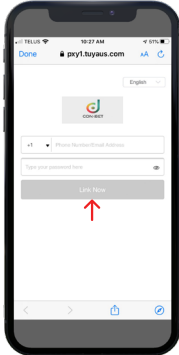
In the search box, enter “Dals Connect” then select it.
- 

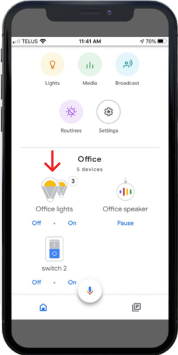
Login with your current account, the same account used during “A4” step.
- 

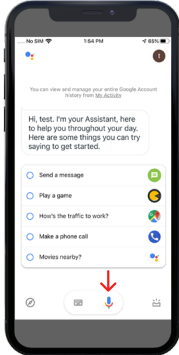
Your Dals smart devices will be listed in the “Home” section. Adding devices to a room enables commands like “turn on the living room lights”.
- 

Try saying, “Ok Google” then...

 - “Turn on light name/ room name”
 - “...Dim light name”
 - “Brighten light name”
 - “Set light name to 20%”
 - “Dim/Brighten light name to 50%”
 - “Turn light name/room name to red”
 - “Turn on/off everything”
 - “Is <light name> on?”

E AMAZON ALEXA

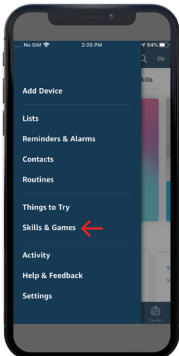
- 

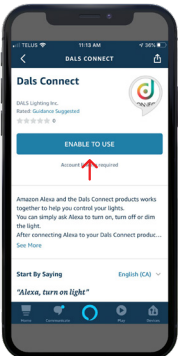
Open the Amazon Alexa app and click on ☰ at the top left corner, then click on “Skills & Games”.
- 

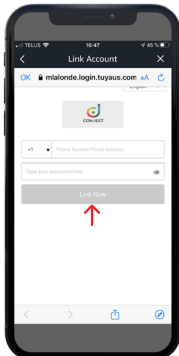
In the search box, enter “Dals Connect”.
You should see the skill appear in the search results. Tap on the “Dals Connect” skill to enable access.
- 

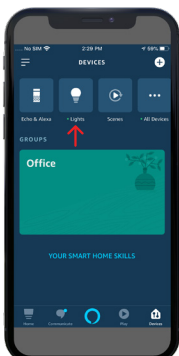
You will need to link your device. Login with your current account, the same account used during “A4” step.
- 

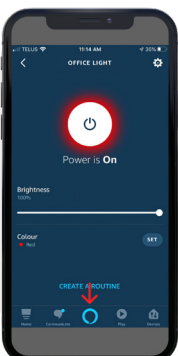
Your smart devices will be listed in the “Devices” tab at the bottom of the home screen. Adding devices to a room enables commands like “turn on the living room lights”.
- 

Try saying, “Alexa” then...

 - “Turn on light name/ room name”
 - “...Dim light name”
 - “Brighten light name”
 - “Set light name to 20%”
 - “Dim/Brighten light name to 50%”
 - “Turn light name/room name to red”
 - “Turn on/off everything”
 - “Is <light name> on?”