

THERMOSTATIC MIXER VALVE WITH BUILT-IN STOPS

MODEL 4DRBICQ

If you need assistance with installation, replacement parts or have any questions regarding your Rubinet product, please call a Customer service representative at: 905-851-6781 toll free 1-800-461-5901 or visit www.rubinet.com

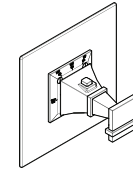

THERMOSTATIC MIXER VALVE

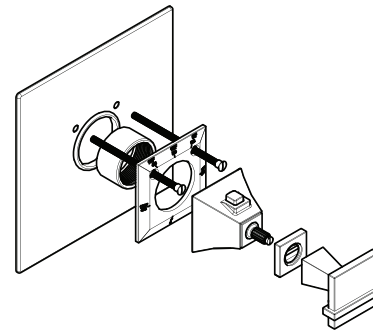

OPERATING INSTRUCTIONS:

IMPORTANT:

- The Thermostatic Mixer Valve is designed to control discharge water temperature only. It does not contain an integral Volume Control/Shut-Off Valve.
- Turn the handle counter clockwise to increase water temperature. It will stop at the Safety Stop position, approx. 100°F (38°C).
- An adult can override the safety stop feature by pressing the Safety Stop Override Bottom and continuing to turn it counter clockwise.

IMPORTANT:

- The safety stop will not automatically "reset" to below 100°F (38°C) when the water is turned off. To protect others from scalding, turn the handle back to the Safety Stop position when finished.
- Turn the handle clockwise to reduce the water temperature.

REMOVAL OF FAUCET:

Always turn the water supply **off** before removing the existing faucet or disassembling a valve. Open both faucet handles to relieve water pressure and to ensure that the water has been successfully turned off.

CARE OF FAUCET:

The use of warm water and a soft cloth is all that is required to clean Rubinet products. The patina of our living finishes (Oil Rubbed Bronze & Tuscan Brass) will change as a result of normal use. Applying Mineral Oil on occasion will create a softer look, subtle color changes and character.

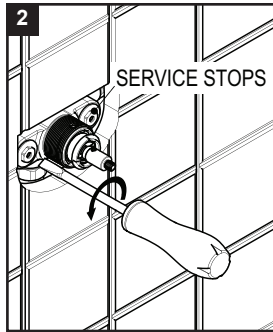
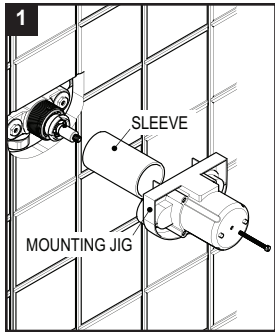

Remove the Mounting Jig and Sleeve only when tiling is complete. Check that both Service Stops are open using a 3/16" flat screwdriver and turning the stems counter clockwise until they stop.

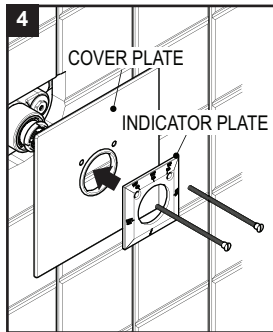
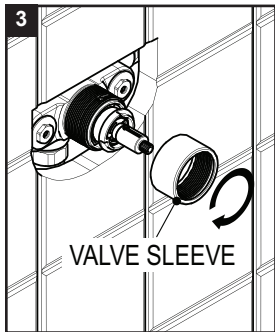

Thread the Valve Sleeve onto the Valve as shown until it stops.

Slide the Cover Plate and Temperature Indicator Plate onto the Valve Sleeve and push them all the way back to the finished wall. Align the Threaded Rods to the corresponding holes in both Plates and the Valve to secure.

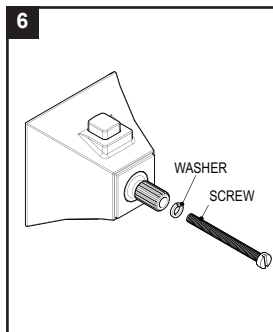
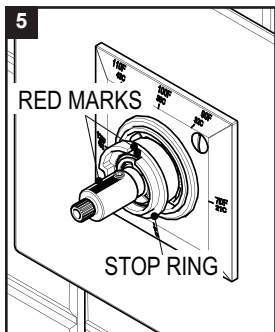

Before installing the Handle make sure the Red Mark on the Valve Stem lines up with the Red Mark on the Stop Ring in the 12 o'clock position.

At this position the temperature of the discharging water should be approximately 100°F (38°C) in most systems

Remove the Screw and Lock Washer from the Handle assembly as shown.

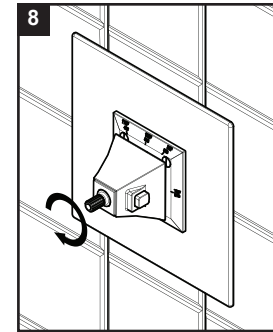
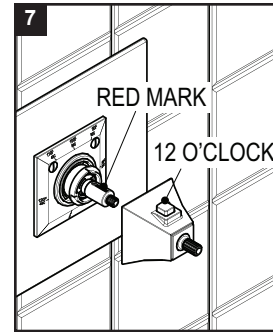

With the Override Button at 12 o'clock and lined up with the Red Mark on the Valve Stem install the Handle.

Turn the Handle clockwise (8) and then counter clockwise (9) until it stops. The Handle should now be in the 12 o'clock position and the Valve should discharge water at approximately 100°F (38°C).

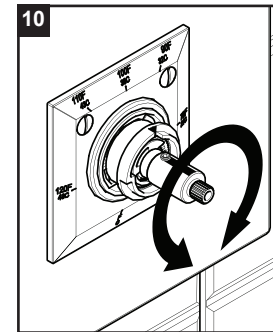
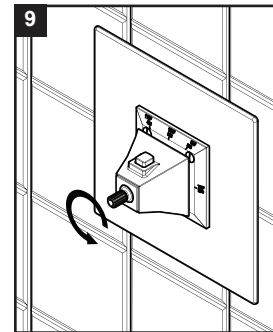

To test the water temperature turn on one of the Volume Control Shut-Off valves down stream from the Thermostatic Valve.

Let the water run for several minutes then place a thermometer in the water stream. If the temperature is not 100°F (38°C) remove the handle.

With the Handle removed turn the Valve Stem clockwise or counter clockwise using pliers to adjust the temperature either up or down until the temperature of 100°F (38°C) is reached.

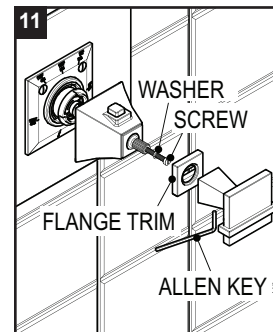

With the temperature set replace and assemble the Handle as shown.

First install the Handle with the Override Button in the 12 o'clock position and secure it with the Lock Washer and Screw. Then install the Matthew Quinn Handle with the Flange Trim between as shown, squeeze firmly together and secure using the Allen Key provided.